

## All India MAHA Mock LIC Assistant Mains (Solutions)

### S1. Ans.(b)

**Sol.** From the given statements, Hindi was taught immediately before Mathematics. Mathematics was taught after Thursday by T3. So, here we have two possible cases i.e. case1 and case2. Two subjects were taught between Hindi and Chemistry. Three subjects were taught between Hindi and Physics.

Days	CASE 1		CASE 2	
	Subjects	Teachers	Subjects	Teachers
Sunday	Physics			
Monday	Chemistry		Physics	
Tuesday			Chemistry	
Wednesday				
Thursday	Hindi			
Friday	Mathematics	T3	Hindi	
Saturday			Mathematics	T3

English was taught before Computer and after Chemistry. History was taught after computer. So, case2 gets eliminated here. The subject taught by T6 was taught immediately before Mathematics. Computer was taught by either T7 or T6. History was taught by T5. Physics was not taught by T4 and T2. English was not taught by T4 which means Chemistry was taught by T4, Physics was taught by T1 and English was taught by T2.

Days	Subjects	Teachers
Sunday	Physics	T1
Monday	Chemistry	T4
Tuesday	English	T2
Wednesday	Computer	T7
Thursday	Hindi	T6
Friday	Mathematics	T3
Saturday	History	T5

### S2. Ans.(d)

**Sol.** From the given statements, Hindi was taught immediately before Mathematics. Mathematics was taught after Thursday by T3. So, here we have two possible cases i.e. case1 and case2. Two subjects were taught between Hindi and Chemistry. Three subjects were taught between Hindi and Physics.

Days	CASE 1		CASE 2	
	Subjects	Teachers	Subjects	Teachers
Sunday	Physics			
Monday	Chemistry		Physics	
Tuesday			Chemistry	
Wednesday				
Thursday	Hindi			
Friday	Mathematics	T3	Hindi	
Saturday			Mathematics	T3

12 Months Subscription

# PREMIUM PLUS BANK & INSURANCE

English was taught before Computer and after Chemistry. History was taught after computer. So, case2 gets eliminated here. The subject taught by T6 was taught immediately before Mathematics. Computer was taught by either T7 or T6. History was taught by T5. Physics was not taught by T4 and T2. English was not taught by T4 which means Chemistry was taught by T4, Physics was taught by T1 and English was taught by T2.

Days	Subjects	Teachers
	Sunday	Physics
Monday	Chemistry	T4
Tuesday	English	T2
Wednesday	Computer	T7
Thursday	Hindi	T6
Friday	Mathematics	T3
Saturday	History	T5

### S3. Ans.(a)

**Sol.** From the given statements, Hindi was taught immediately before Mathematics. Mathematics was taught after Thursday by T3. So, here we have two possible cases i.e. case1 and case2. Two subjects were taught between Hindi and Chemistry. Three subjects were taught between Hindi and Physics.

Days	CASE 1		CASE 2	
	Subjects	Teachers	Subjects	Teachers
Sunday	Physics			
Monday	Chemistry		Physics	
Tuesday			Chemistry	
Wednesday				
Thursday	Hindi			
Friday	Mathematics	T3	Hindi	
Saturday			Mathematics	T3

English was taught before Computer and after Chemistry. History was taught after computer. So, case2 gets eliminated here. The subject taught by T6 was taught immediately before Mathematics. Computer was taught by either T7 or T6. History was taught by T5. Physics was not taught by T4 and T2. English was not taught by T4 which means Chemistry was taught by T4, Physics was taught by T1 and English was taught by T2.

Days	Subjects	Teachers
	Sunday	Physics
Monday	Chemistry	T4
Tuesday	English	T2
Wednesday	Computer	T7
Thursday	Hindi	T6
Friday	Mathematics	T3
Saturday	History	T5

**S4. Ans.(c)**

**Sol.** From the given statements, Hindi was taught immediately before Mathematics. Mathematics was taught after Thursday by T3. So, here we have two possible cases i.e. case1 and case2. Two subjects were taught between Hindi and Chemistry. Three subjects were taught between Hindi and Physics.

Days	CASE 1		CASE 2	
	Subjects	Teachers	Subjects	Teachers
Sunday	Physics			
Monday	Chemistry		Physics	
Tuesday			Chemistry	
Wednesday				
Thursday	Hindi			
Friday	Mathematics	T3	Hindi	
Saturday			Mathematics	T3

English was taught before Computer and after Chemistry. History was taught after computer. So, case2 gets eliminated here. The subject taught by T6 was taught immediately before Mathematics. Computer was taught by either T7 or T6. History was taught by T5. Physics was not taught by T4 and T2. English was not taught by T4 which means Chemistry was taught by T4, Physics was taught by T1 and English was taught by T2.

Days	Subjects	Teachers
Sunday	Physics	T1
Monday	Chemistry	T4
Tuesday	English	T2
Wednesday	Computer	T7
Thursday	Hindi	T6
Friday	Mathematics	T3
Saturday	History	T5

**S5. Ans.(d)**

**Sol.** From the given statements, Hindi was taught immediately before Mathematics. Mathematics was taught after Thursday by T3. So, here we have two possible cases i.e. case1 and case2. Two subjects were taught between Hindi and Chemistry. Three subjects were taught between Hindi and Physics.

Days	CASE 1		CASE 2	
	Subjects	Teachers	Subjects	Teachers
Sunday	Physics			
Monday	Chemistry		Physics	
Tuesday			Chemistry	
Wednesday				
Thursday	Hindi			
Friday	Mathematics	T3	Hindi	
Saturday			Mathematics	T3

English was taught before Computer and after Chemistry. History was taught after computer. So, case2 gets eliminated here. The subject taught by T6 was taught immediately before Mathematics. Computer was taught by either T7 or T6. History was taught by T5. Physics was not taught by T4 and T2. English was not taught by T4 which means Chemistry was taught by T4, Physics was taught by T1 and English was taught by T2.

Days	Subjects	Teachers
Sunday	Physics	T1
Monday	Chemistry	T4
Tuesday	English	T2
Wednesday	Computer	T7
Thursday	Hindi	T6
Friday	Mathematics	T3
Saturday	History	T5

TEST SERIES  
Bilingual  
VIDEO SOLUTIONS



**IBPS CLERK  
MAINS**

25 TOTAL TESTS

Validity : 12 Months

S6. Ans.(a)

Sol.

BUK TYS QPI NEX CAG UBL OPH  
BKU STY IPQ ENX ACG BLU HOP  
ACG BKU **BLU** ENX HOP IPQ STY

S7. Ans.(c)

Sol.

Third letter of the second word from the right end = L

Second letter of the second word from the left end = Y

Number of letters (according to the English alphabetical series) between Y and L = 12

S8. Ans.(e)

Sol.

BUK TYS QPI NEX CAG UBL OPH  
AVJ SXR POJ MFW BFB VAK POG

S9. Ans. (b)

Sol. First one can be directly concluded from the statement. Second one can be inferred from the statement as the main motive of Reliance Jio is the enhancement in the field of mobile infrastructure which is there in the statement in hidden manner.

S10. Ans.(a)

Sol. Chocolates have three types of fats, one out of which increase level of cholesterol thus this statement weakens the argument because it is showing negative quality of chocolates.

S11. Ans.(a)

Sol.

From the given statements, T lives on 2<sup>nd</sup> floor and works at BOB. V lives below T's floor. No one lives between T's and S's floor. Not more than one floor gap is between T's and S's floors. So, here we have the two possible cases i.e. case1 and case 2. The one who lives at the topmost floor works at BOI bank. The one who works at BOI lives immediately above the one who works at UCO bank. The one who works at UCO bank lives immediately above the vacant floor. There are two floors gap between U's and S's floors. U lives immediately above Q's floor.

FLOORS	CASE 1		CASE 2	
	Persons	Banks	Persons	Banks
10		BOI		BOI
9		UCO		UCO
8	Vacant	-----	Vacant	
7	Vacant	-----	U	
6	U		Q	
5	Q		Vacant	-----
4	Vacant	-----	S	
3	S		Vacant	-----
2	T	BOB	T	BOB
1	V		V	

The number of floors between S and U are same as the number of floors between S and V. So, case 1 gets eliminated here. . The one who lives at the fourth floor works at HDFC bank which means S works at HDFC bank. R works in BOI and lives immediately above P's floor. The one who works at ICICI bank lives on an even numbered floor. U doesn't works at OBC bank which means U works at SBI and V works at OBC. So, the final arrangement is:

FLOORS	Persons	Banks
	10	R
9	P	UCO
8	Vacant	-----
7	U	SBI
6	Q	ICICI
5	Vacant	-----
4	S	HDFC
3	Vacant	-----
2	T	BOB
1	V	OBC

**S12. Ans.(c)**

**Sol.**  
From the given statements, T lives on 2<sup>nd</sup> floor and works at BOB. V lives below T's floor. No one lives between T's and S's floor. Not more than one floor gap is between T's and S's floors. So, here we have the two possible cases i.e. case1 and case 2. The one who lives at the topmost floor works at BOI bank. The one who works at BOI lives immediately above the one who works at UCO bank. The one who works at UCO bank lives immediately above the vacant floor. There are two floors gap between U's and S's floors. U lives immediately above Q's floor.

FLOORS	CASE 1		CASE 2	
	Persons	Banks	Persons	Banks
10		BOI		BOI
9		UCO		UCO
8	Vacant	-----	Vacant	
7	Vacant	-----	U	
6	U		Q	
5	Q		Vacant	-----
4	Vacant	-----	S	
3	S		Vacant	-----
2	T	BOB	T	BOB
1	V		V	

The number of floors between S and U are same as the number of floors between S and V. So, case 1 gets eliminated here. . The one who lives at the fourth floor works at HDFC bank which means S works at HDFC bank. R works in BOI and lives immediately above P's floor. The one who works at ICICI bank lives on an even numbered floor. U doesn't works at OBC bank which means U works at SBI and V works at OBC. So, the final arrangement is:

FLOORS	Persons	Banks
	10	R
9	P	UCO
8	Vacant	-----
7	U	SBI
6	Q	ICICI
5	Vacant	-----
4	S	HDFC
3	Vacant	-----
2	T	BOB
1	V	OBC

**S13. Ans.(b)**

**Sol.**

From the given statements, T lives on 2<sup>nd</sup> floor and works at BOB. V lives below T's floor. No one lives between T's and S's floor. Not more than one floor gap is between T's and S's floors. So, here we have the two possible cases i.e. case1 and case 2. The one who lives at the topmost floor works at BOI bank. The one who works at BOI lives immediately above the one who works at UCO bank. The one who works at UCO bank lives immediately above the vacant floor. There are two floors gap between U's and S's floors. U lives immediately above Q's floor.

FLOORS	CASE 1		CASE 2	
	Persons	Banks	Persons	Banks
10		BOI		BOI
9		UCO		UCO
8	Vacant	-----	Vacant	
7	Vacant	-----	U	
6	U		Q	
5	Q		Vacant	-----
4	Vacant	-----	S	
3	S		Vacant	-----
2	T	BOB	T	BOB
1	V		V	

The number of floors between S and U are same as the number of floors between S and V. So, case 1 gets eliminated here. . The one who lives at the fourth floor works at HDFC bank which means S works at HDFC bank. R works in BOI and lives immediately above P's floor. The one who works at ICICI bank lives on an even numbered floor. U doesn't works at OBC bank which means U works at SBI and V works at OBC. So, the final arrangement is:

FLOORS	Persons	Banks
	10	R
9	P	UCO
8	Vacant	-----
7	U	SBI
6	Q	ICICI
5	Vacant	-----
4	S	HDFC
3	Vacant	-----
2	T	BOB
1	V	OBC

**S14. Ans.(e)**

**Sol.** From the given statements, T lives on 2<sup>nd</sup> floor and works at BOB. V lives below T's floor. No one lives between T's and S's floor. Not more than one floor gap is between T's and S's floors. So, here we have the two possible cases i.e. case1 and case 2. The one who lives at the topmost floor works at BOI bank. The one who works at BOI lives immediately above the one who works at UCO bank. The one who works at UCO bank lives immediately above the vacant floor. There are two floors gap between U's and S's floors. U lives immediately above Q's floor.

FLOORS	CASE 1		CASE 2	
	Persons	Banks	Persons	Banks
10		BOI		BOI
9		UCO		UCO
8	Vacant	-----	Vacant	
7	Vacant	-----	U	
6	U		Q	
5	Q		Vacant	-----
4	Vacant	-----	S	
3	S		Vacant	-----
2	T	BOB	T	BOB
1	V		V	

The number of floors between S and U are same as the number of floors between S and V. So, case 1 gets eliminated here. . The one who lives at the fourth floor works at HDFC bank which means S works at HDFC bank. R works in BOI and lives immediately above P's floor. The one who works at ICICI bank lives on an even numbered floor. U doesn't works at OBC bank which means U works at SBI and V works at OBC. So, the final arrangement is:

FLOORS	Persons	Banks
10	R	BOI
9	P	UCO
8	Vacant	-----
7	U	SBI
6	Q	ICICI
5	Vacant	-----
4	S	HDFC
3	Vacant	-----
2	T	BOB
1	V	OBC

TEST SERIES

Bilingual

Video Solutions

**SBI PO 2020**

**PRIME**

135+ TOTAL TESTS | eBOOKS

Validity : 12 Months

**S15. Ans.(d)**

**Sol.** From the given statements, T lives on 2<sup>nd</sup> floor and works at BOB. V lives below T's floor. No one lives between T's and S's floor. Not more than one floor gap is between T's and S's floors. So, here we have the two possible cases i.e. case1 and case 2. The one who lives at the topmost floor works at BOI bank. The one who works at BOI lives immediately above the one who works at UCO bank. The one who works at UCO bank lives immediately above the vacant floor. There are two floors gap between U's and S's floors. U lives immediately above Q's floor.

FLOORS	CASE 1		CASE 2	
	Persons	Banks	Persons	Banks
10		BOI		BOI
9		UCO		UCO
8	Vacant	-----	Vacant	
7	Vacant	-----	U	
6	U		Q	
5	Q		Vacant	-----
4	Vacant	-----	S	
3	S		Vacant	-----
2	T	BOB	T	BOB
1	V		V	

The number of floors between S and U are same as the number of floors between S and V. So, case 1 gets eliminated here. . The one who lives at the fourth floor works at HDFC bank which means S works at HDFC bank. R works in BOI and lives immediately above P's floor. The one who works at ICICI bank lives on an even numbered floor. U doesn't works at OBC bank which means U works at SBI and V works at OBC. So, the final arrangement is:

FLOORS	Persons	Banks
	10	R
9	P	UCO
8	Vacant	-----
7	U	SBI
6	Q	ICICI
5	Vacant	-----
4	S	HDFC
3	Vacant	-----
2	T	BOB
1	V	OBC

**S16. Ans.(d)**

**Sol.** From the given statement A sits at the extreme end of the row and likes X. Only two persons sit between A and the one who likes Z. The one who likes W is an immediate neighbor of the one who likes Z. So we have four possible cases:

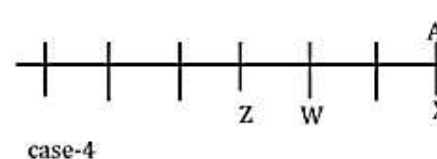
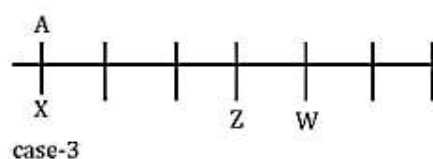
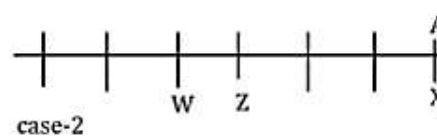
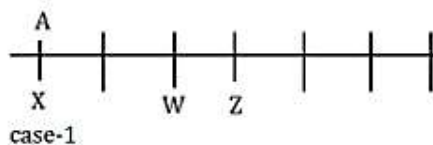



Three persons sit between the one who likes W and G. So case-2 and case-3 is eliminated. D is an immediate neighbor of F and the one who likes S.F likes Z. C sits immediate left of E. D does not like W. So the following is the arrangement:

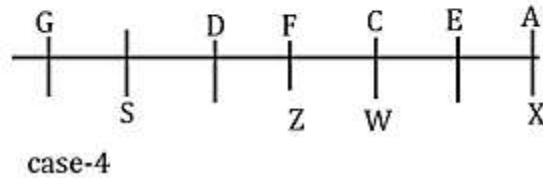
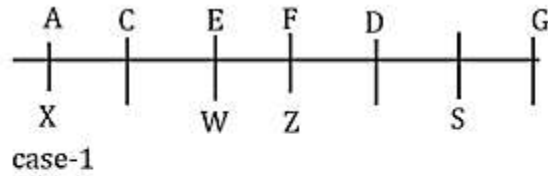

The one who like T sits immediate left of B. G does not like T and Y means case-4 is eliminated. C does not like Q which means G likes Q and C likes Y. So the final arrangement is:

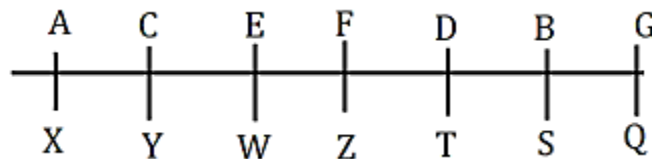

**S17. Ans.(c)**

**Sol.**  
From the given statement A sits at the extreme end of the row and likes X. Only two persons sit between A and the one who likes Z. The one who likes W is an immediate neighbor of the one who likes Z. So we have four possible cases:

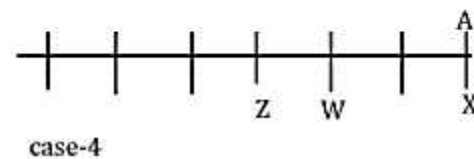
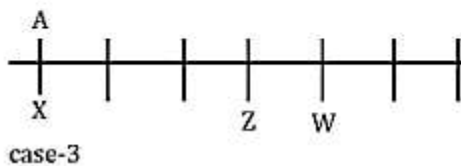
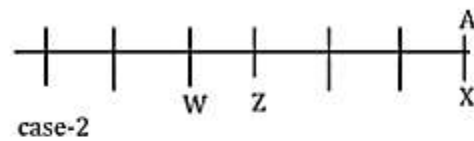
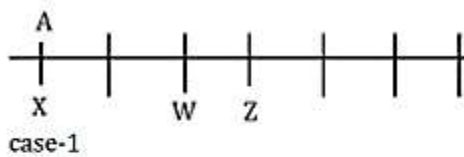

Three persons sit between the one who likes W and G. So case-2 and case-3 is eliminated. D is an immediate neighbor of F and the one who likes S.F likes Z. C sits immediate left of E. D does not like W. So the following is the arrangement:

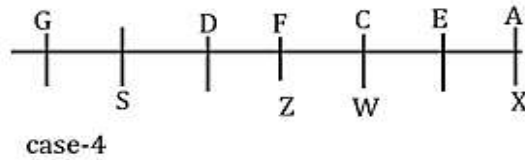
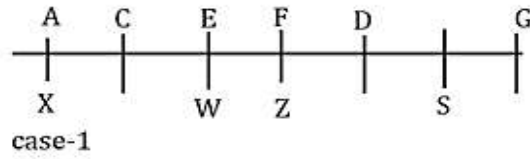

The one who like T sits immediate left of B. G does not like T and Y means case-4 is eliminated. C does not like Q which means G likes Q and C likes Y. So the final arrangement is:

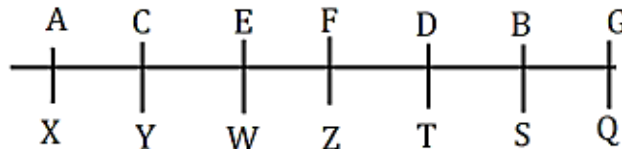

**S18. Ans.(d)**

**Sol.** From the given statement A sits at the extreme end of the row and likes X. Only two persons sit between A and the one who likes Z. The one who likes W is an immediate neighbor of the one who likes Z. So we have four possible cases:

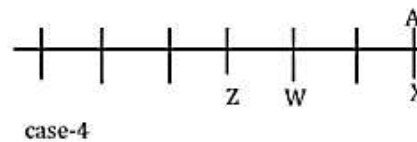
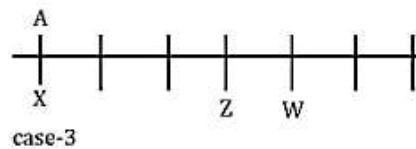
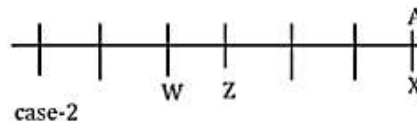
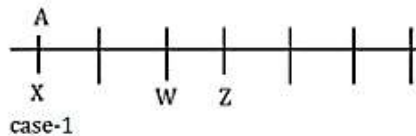

Three persons sit between the one who likes W and G. So case-2 and case-3 is eliminated. D is an immediate neighbor of F and the one who likes S. F likes Z. C sits immediate left of E. D does not like W. So the following is the arrangement:

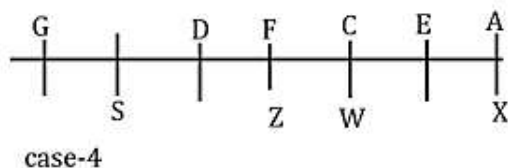
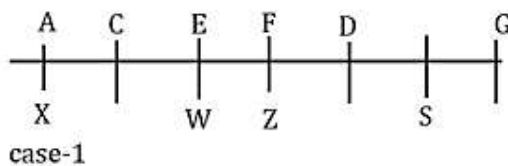

12 Months Subscription

**PREMIUMPLUS**  
**BANK & INSURANCE**

The one who like T sits immediate left of B. G does not like T and Y means case-4 is eliminated. C does not like Q which means G likes Q and C likes Y. So the final arrangement is:

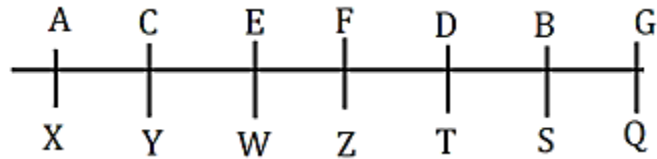

S19. Ans. (e)

Sol.

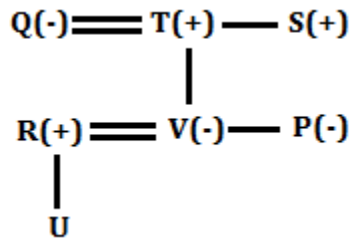

S20. Ans. (b)

Sol.

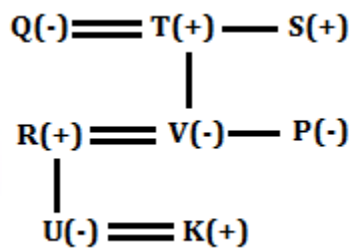

S21. Ans.(c)

Sol.

adda247

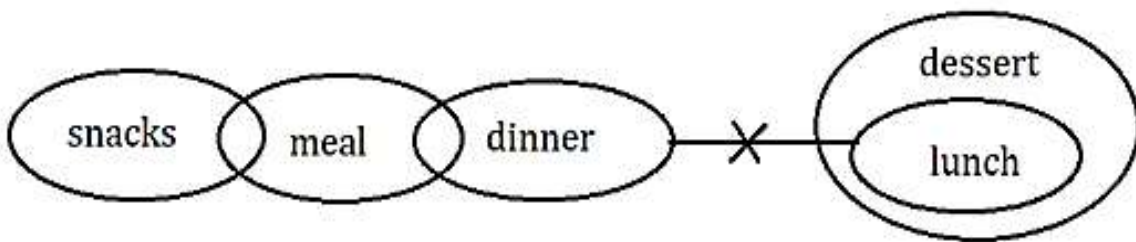

S22. Ans.(b)

Sol.

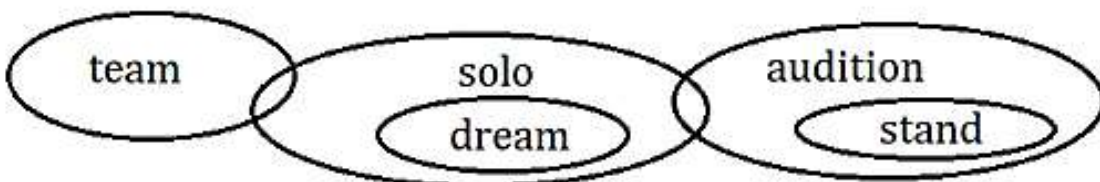

S23. Ans.(b)

Sol.

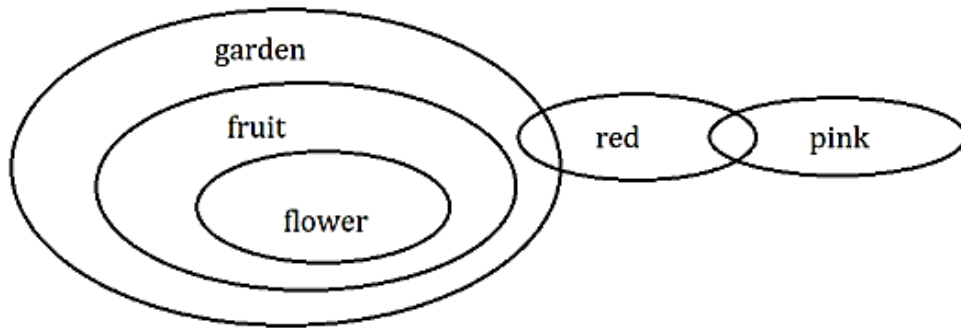

S24. Ans.(b)

Sol. From the given statement, only two persons sit between A and F. Three persons sit between F and H. So, we have four possible cases:

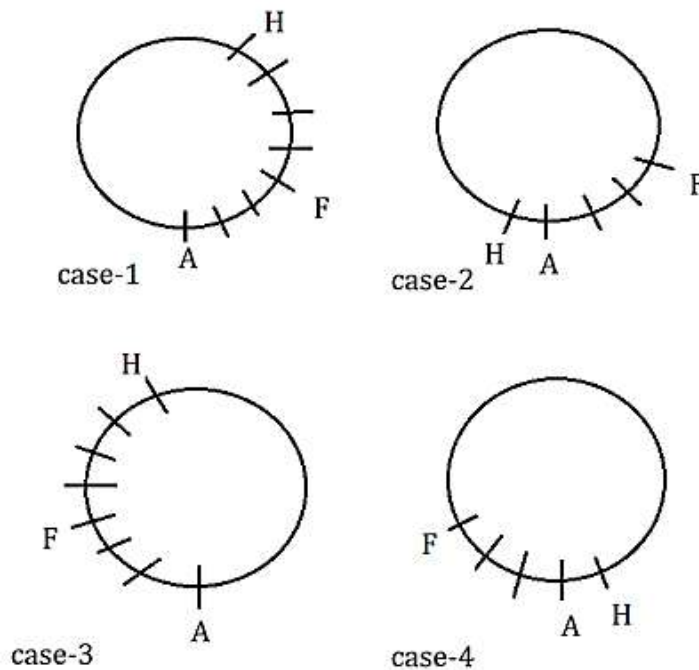

G is an immediate neighbor of both H and A. So, case-2 and case-4 is eliminated. Only one person sits between H and C. C is an immediate neighbor of D and E. D sits third to the right of I. So case-3 is eliminated. So, the final arrangement is:

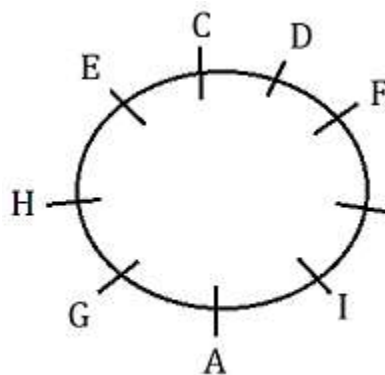

**S25. Ans(c)**

**Sol.** From the given statement, only two persons sit between A and F. Three persons sit between F and H. So, we have four possible cases:

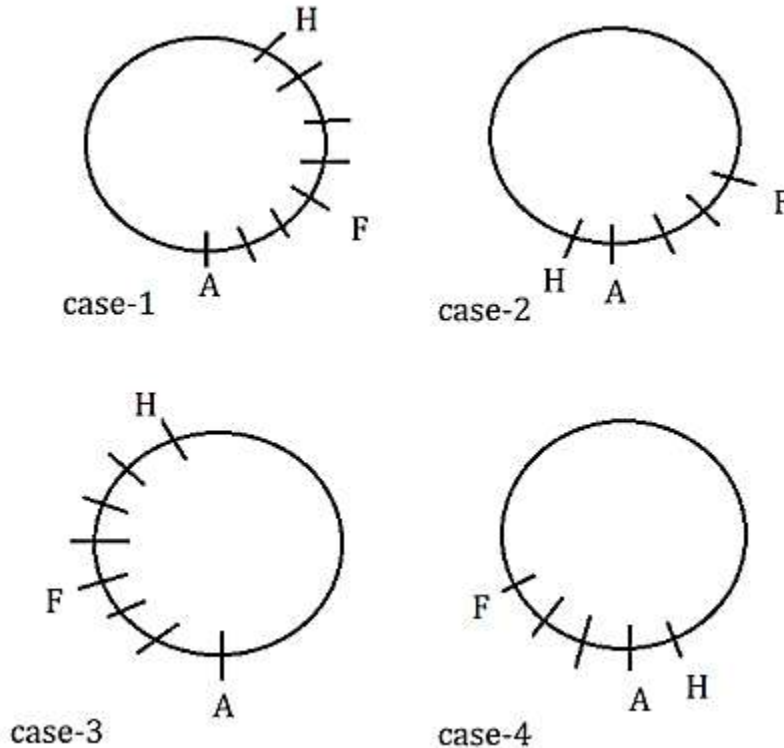

G is an immediate neighbor of both H and A. So, case-2 and case-4 is eliminated. Only one person sits between H and C. C is an immediate neighbor of D and E. D sits third to the right of I. So case-3 is eliminated. So, the final arrangement is:

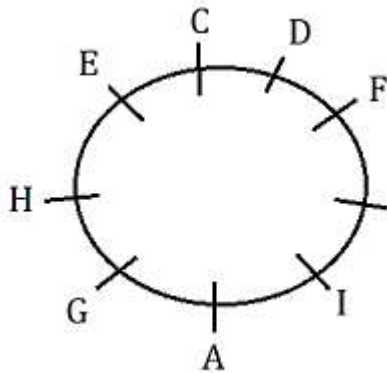

**S26. Ans.(a)**

**Sol.**

**Sol.** From the given statement, only two persons sit between A and F. Three persons sit between F and H. So, we have four possible cases:

TEST SERIES  
Bilingual  
VIDEO SOLUTIONS



**IBPS CLERK  
MAINS**

25 TOTAL TESTS

Validity : 12 Months

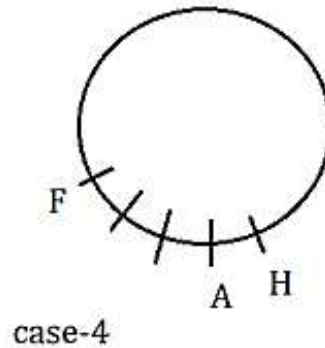
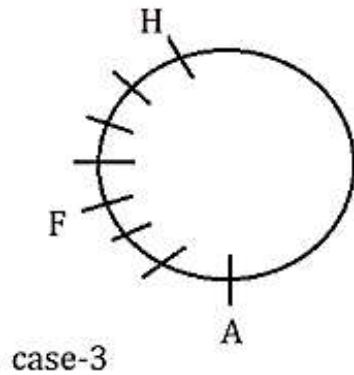
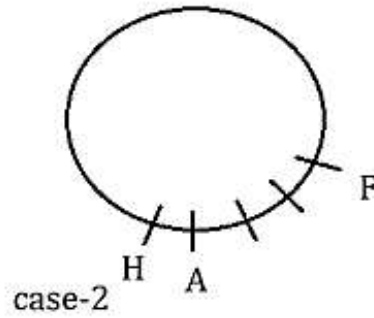
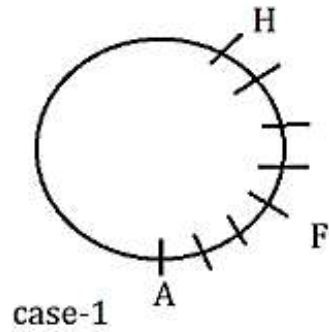

G is an immediate neighbor of both H and A. So, case-2 and case-4 is eliminated. Only one person sits between H and C. C is an immediate neighbor of D and E. D sits third to the right of I. So case-3 is eliminated. So, the final arrangement is:

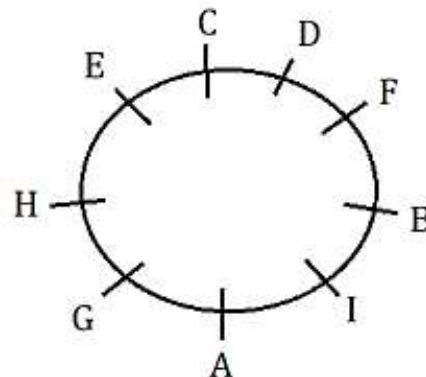
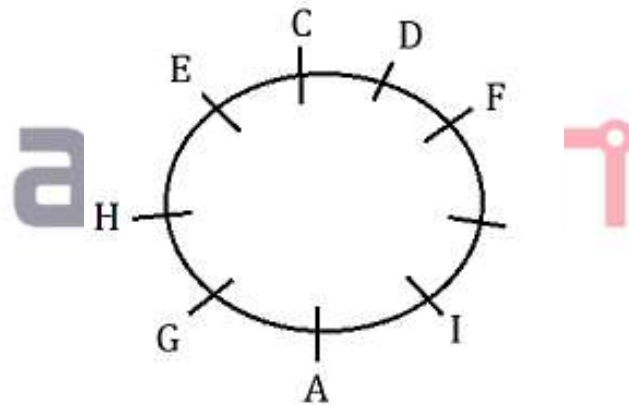

**S27. Ans.(e)**

**Sol.** From the given statement, only two persons sit between A and F. Three persons sit between F and H. So, we have four possible cases:

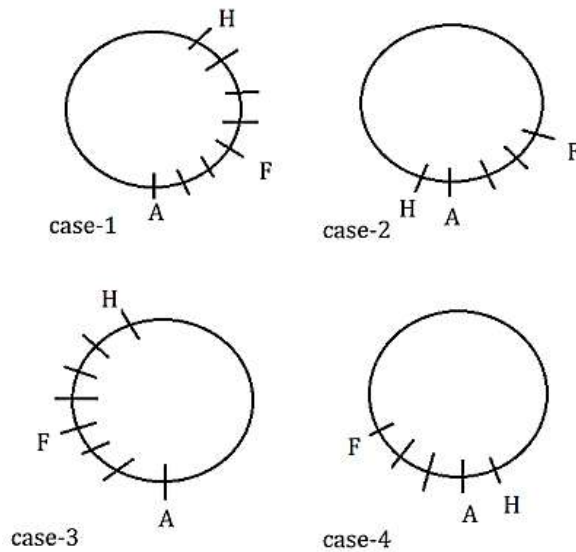

G is an immediate neighbor of both H and A. So, case-2 and case-4 is eliminated. Only one person sits between H and C. C is an immediate neighbor of D and E. D sits third to the right of I. So case-3 is eliminated. So, the final arrangement is:

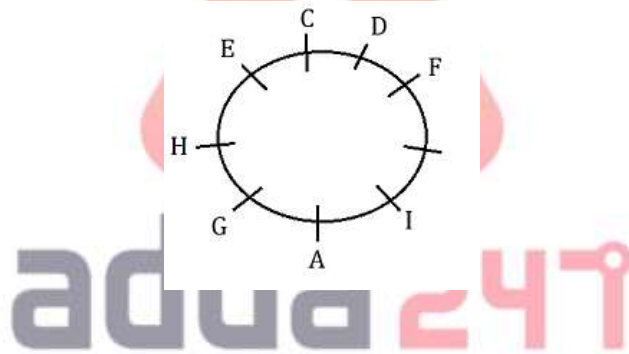

**S28. Ans.(d)**

**Sol.** From the given statement, only two persons sit between A and F. Three persons sit between F and H. So, we have four possible cases:

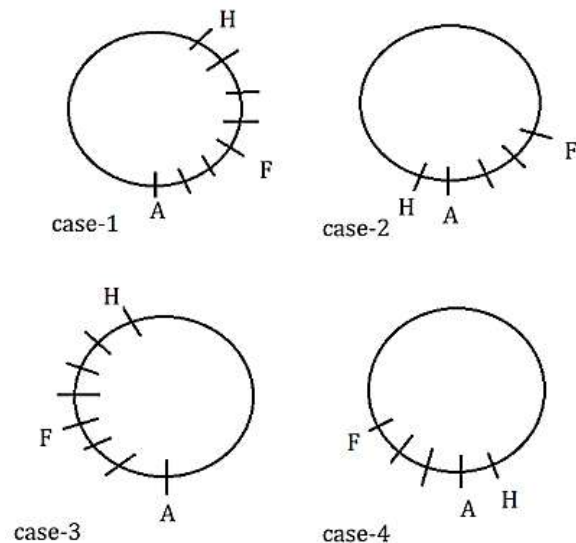

G is an immediate neighbor of both H and A. So, case-2 and case-4 is eliminated. Only one person sits between H and C. C is an immediate neighbor of D and E. D sits third to the right of I. So case-3 is eliminated. So, the final arrangement is:

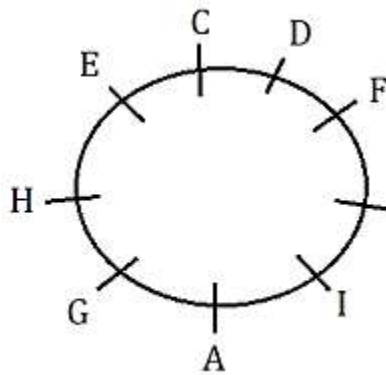

TEST SERIES  
 Bilingual  
 Video Solutions

**SBI PO 2020**  
**PRIME**

135+ TOTAL TESTS | eBOOKS

Validity : 12 Months

**S29. Ans.(c)**

**Sol.** Manipulation of data in computer is called processing.

**S30. Ans.(c)**

**Sol.** Analytical engine was developed by Charles Babbage.

**S31. Ans.(b)**

**S32. Ans.(a)**

**Sol.** From the given statements, C faces the one who buys T4. R sits immediate left of C and both of them do not buy any item. So, we have two possible cases:

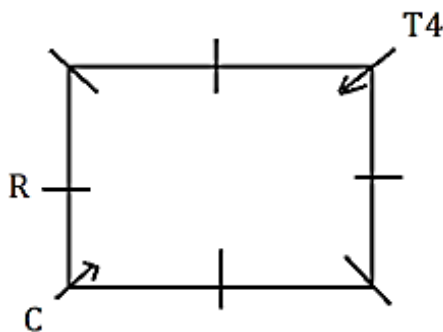

Case-1

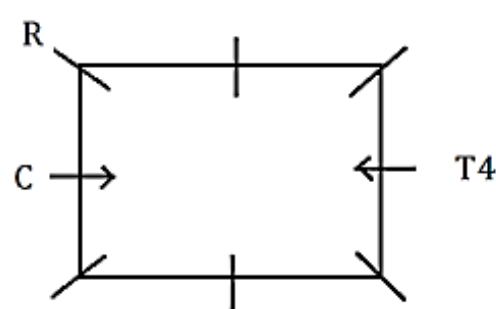

Case-2

Only two persons faces towards the center of the table. A and B are not neighbors of each other but both are sitting on the middle of the table means they sit opposite to each other. A is an immediate neighbor of both P and R. The P and Q are not neighbors of each other, but both are sitting on the corners means they also sit opposite to each other. B likes T2. S sits second to the left of the one who buys T3. The one who buys T1 sits third to the left of S. D sits at the middle of the table. So, case-1 is eliminated. Hence the final arrangement is:



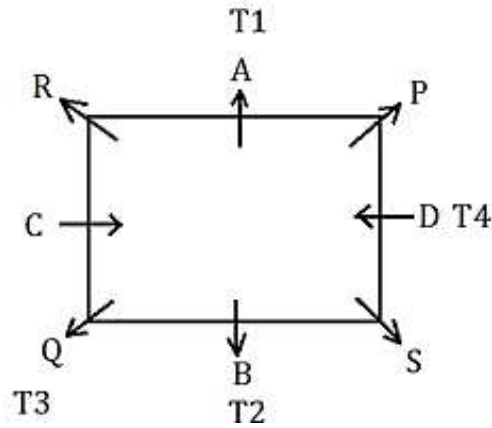

**S33. Ans.(b)**

**Sol.** From the given statements, C faces the one who buys T4. R sits immediate left of C and both of them do not buy any item. So, we have two possible cases:

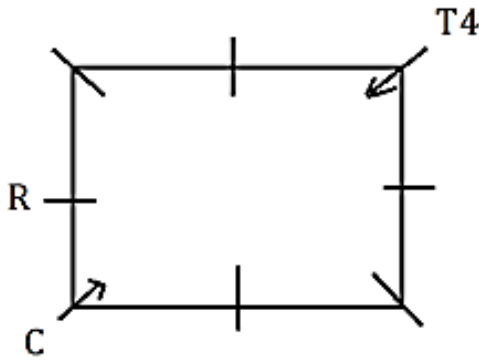

Case-1

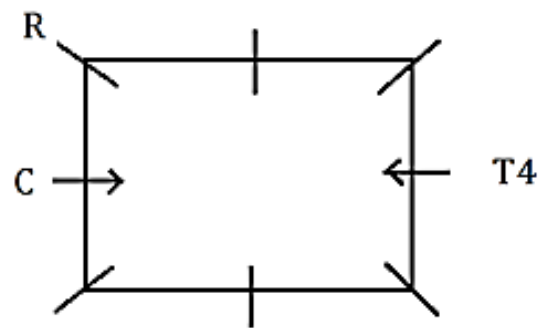

Case-2

Only two persons face towards the center of the table. A and B are not neighbors of each other but both are sitting on the middle of the table means they sit opposite to each other. A is an immediate neighbor of both P and R. The P and Q are not neighbors of each other, but both are sitting on the corners means they also sit opposite to each other. B likes T2. S sits second to the left of the one who buys T3. The one who buys T1 sits third to the left of S. D sits at the middle of the table. So, case-1 is eliminated. Hence the final arrangement is:

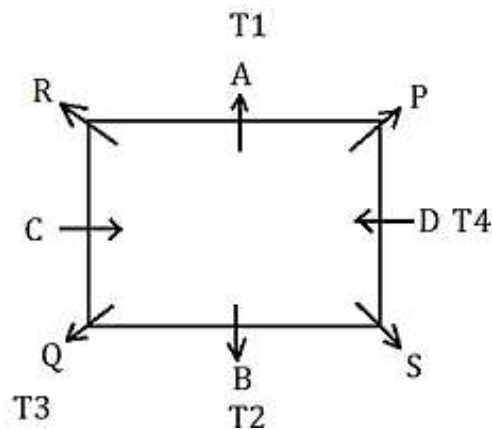

**S34. Ans.(c)**

**Sol.** From the given statements, C faces the one who buys T4. R sits immediate left of C and both of them do not buy any item. So, we have two possible cases:

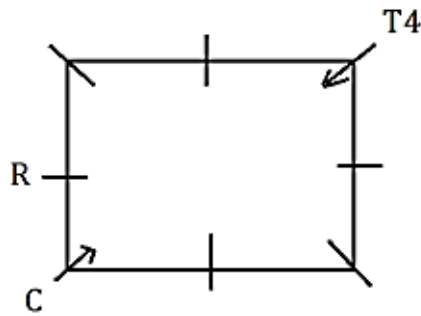

Case-1

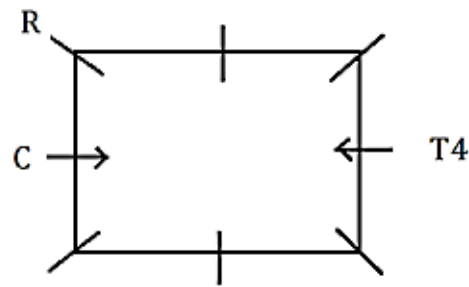

Case-2

Only two persons faces towards the center of the table. A and B are not neighbors of each other but both are sitting on the middle of the table means they sit opposite to each other. A is an immediate neighbor of both P and R. The P and Q are not neighbors of each other, but both are sitting on the corners means they also sit opposite to each other. B likes T2. S sits second to the left of the one who buys T3. The one who buys T1 sits third to the left of S. D sits at the middle of the table. So, case-1 is eliminated. Hence the final arrangement is:

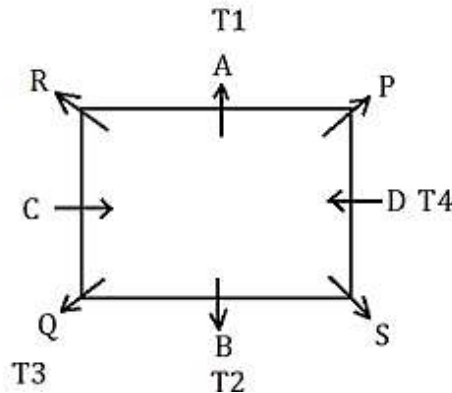

**S35. Ans.(c)**

**Sol.** From the given statements, C faces the one who buys T4. R sits immediate left of C and both of them do not buy any item. So, we have two possible cases:

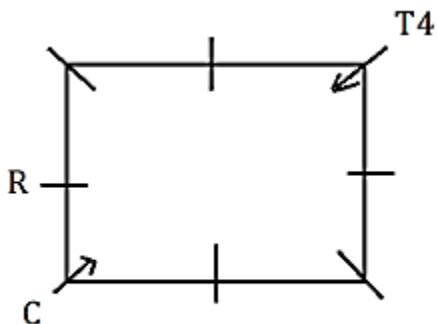

Case-1

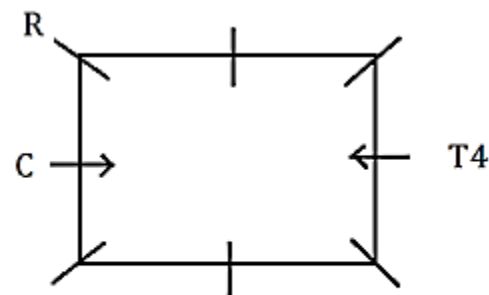

Case-2

Only two persons faces towards the center of the table. A and B are not neighbors of each other but both are sitting on the middle of the table means they sit opposite to each other. A is an immediate neighbor of both P and R. The P and Q are not neighbors of each other, but both are sitting on the corners means they also sit opposite to each other. B likes T2. S sits second to the left of the one who buys T3. The one who buys T1 sits third to the left of S. D sits at the middle of the table. So, case-1 is eliminated. Hence the final arrangement is:

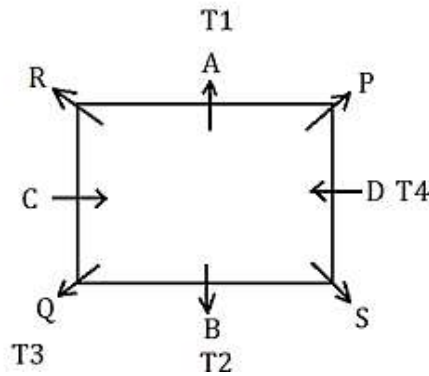

**S36. Ans.(b)**

**Sol.** From the given statements, C faces the one who buys T4. R sits immediate left of C and both of them do not buy any item. So, we have two possible cases:

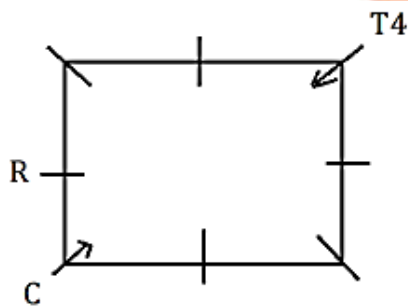

Case-1

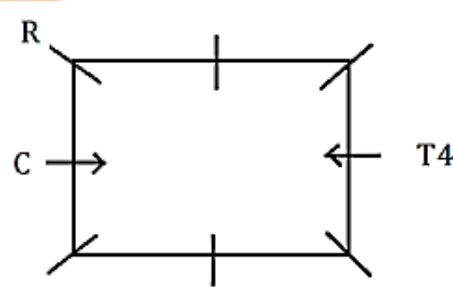

Case-2

Only two persons faces towards the center of the table. A and B are not neighbors of each other but both are sitting on the middle of the table means they sit opposite to each other. A is an immediate neighbor of both P and R. The P and Q are not neighbors of each other, but both are sitting on the corners means they also sit opposite to each other. B likes T2. S sits second to the left of the one who buys T3. The one who buys T1 sits third to the left of S. D sits at the middle of the table. So, case-1 is eliminated. Hence the final arrangement is:

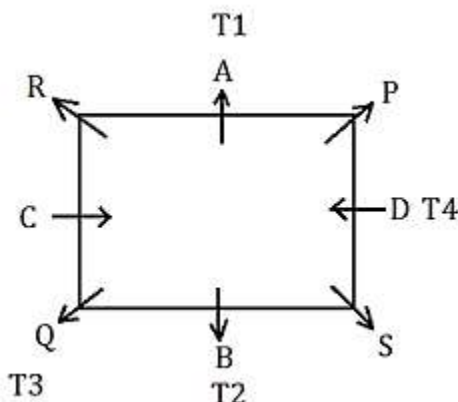

12 Months Subscription



**PREMIUMPLUS**  
**BANK & INSURANCE**

S37. Ans.(d)

Sol.

S A C R I L E G E S

A C E E G I L R S S



S38. Ans.(c)

Sol. Logic:

count the number of letters in the given word then write the letter which has the same place value as the number of letters

Prank → 25 | E @ — if the word starts with a consonant use @  
 if the word starts with a vowel use #

square of the number of letters

S39. Ans.(b)

Sol. Logic:

count the number of letters in the given word then write the letter which has the same place value as the number of letters

Prank → 25 | E @ — if the word starts with a consonant use @  
 if the word starts with a vowel use #

square of the number of letters

S40. Ans.(d)

Sol. Logic:

count the number of letters in the given word then write the letter which has the same place value as the number of letters

Prank → 25 | E @ — if the word starts with a consonant use @  
 if the word starts with a vowel use #

square of the number of letters

**S41. Ans.(c)**

**Sol.** In the above question we have to find the result of the above statement.

For I-This cannot be the result because if a person does not have Aadhar, he/she will not get government help in treatment but can take treatment of TB without Aadhar.

For II-This could be the result as mentioned in the given statement that patients need Aadhar card to get benefits under government scheme.

For III-This also could be the result because it is clear from the given statement that to get benefits of the scheme verification of Aadhar will be required.

For IV-This is not the result of the given statement because this statement states that cases of TB patients increased in India now which is not directly related to the statement.

**S42. Ans.(c)**

**Sol.** For I- This argument does not holds strong because this initiative is for girls to get benefited initially but it is not like that education will make free for everyone.

For II-This argument also holds strong because a law/scheme or bill should not be for any particular gender, but it should be for the one who really need it.

For III-This is also strong because gender should not be the criterion for the free education. It is the poor who should get the benefits.

**S43. Ans.(b)**

**Sol.** In the above question we have to find which statement supports the given statement.

For I-This statement supports the given statement because there should be some guideline on social media to stop this anti national propaganda as given in the statement.

For II-This is also true because this move will help to stop terrorist from using social media as a platform to encourage terrorism.

For III-It also substantiates the importance of this policy as rumors on social media will further provoke riots in the country.

For IV-This could not substantiate from the given statement as it states that only social media is responsible for terror activities in Jammu and Kashmir. So this is false.

**S44. Ans.(d)**

**Sol.**

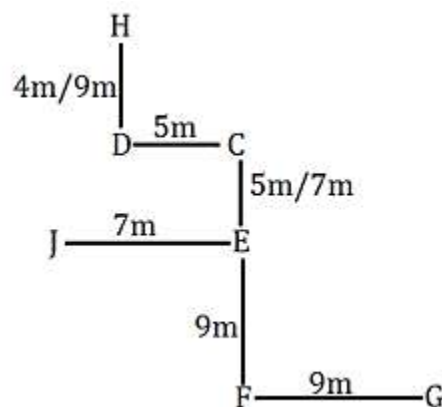

S45. Ans.(b)

Sol.

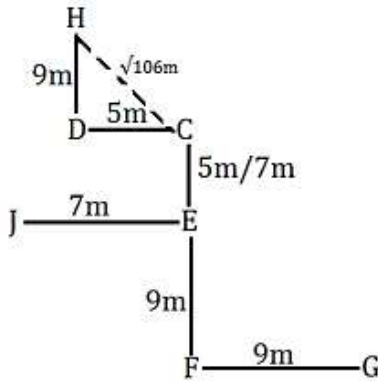

S46. Ans.(a)

Sol.

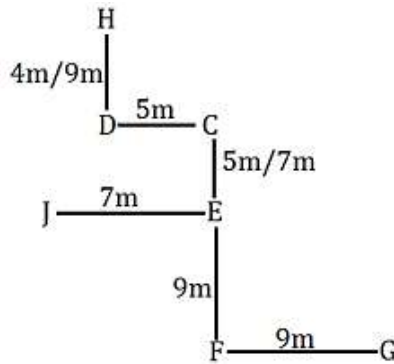

S47. Ans.(a)

Sol.

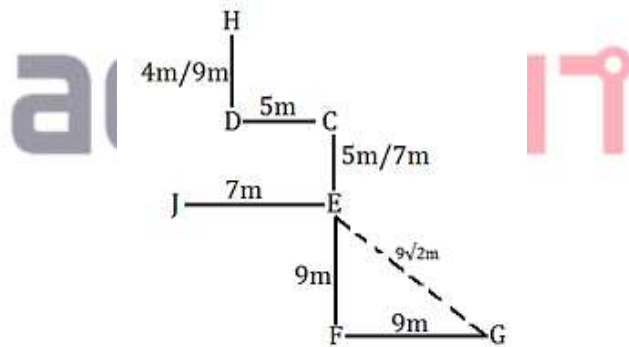

S48. Ans.(e)

Sol.

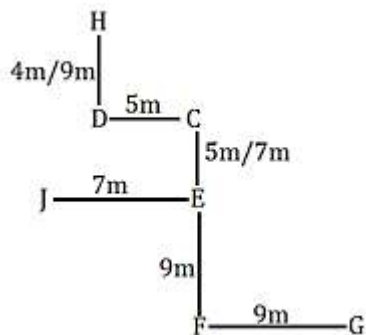

TEST SERIES  
Bilingual  
VIDEO SOLUTIONS



**IBPS CLERK  
MAINS**

25 TOTAL TESTS

Validity : 12 Months

**S49. Ans.(d)**

**Sol.** Control key is a modifier key which performs a special operation.

**S50. Ans.(a)**

**Sol.** Pascal is an efficient language intended to encourage good programming practices using structured programming and data structuring.

**S51. Ans.(c)**

**Sol.** From the given statements, P sits at one of the extreme end of row I. Two persons sit between P and the one who likes Palm grove. Q sits in row I and is not an immediate neighbor of P. R is an immediate neighbor of the one who likes Landmark and Q. Q does not like Landmark and does not sit at any of the extreme end. So, we have two possible cases:

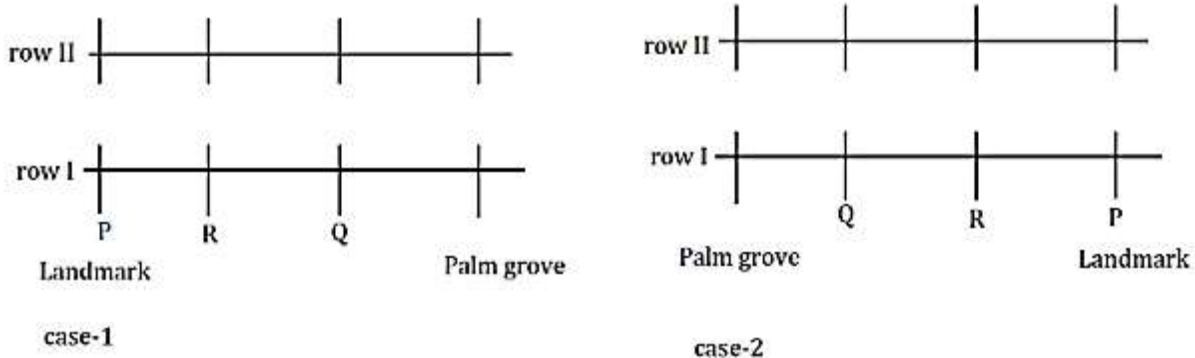

C sits in row II and is an immediate neighbor of the one who likes Flurry's. A who likes Trident sits second to the right of the one who like Flurry's. B sits immediately left of A. B likes Palace and sits in the same row as the one who likes Oberoi. The one who likes Taj sit second to the left of S. D faces the one who likes J W Marriot. Here Case 2 is ruled out now.

So, the final arrangement is:

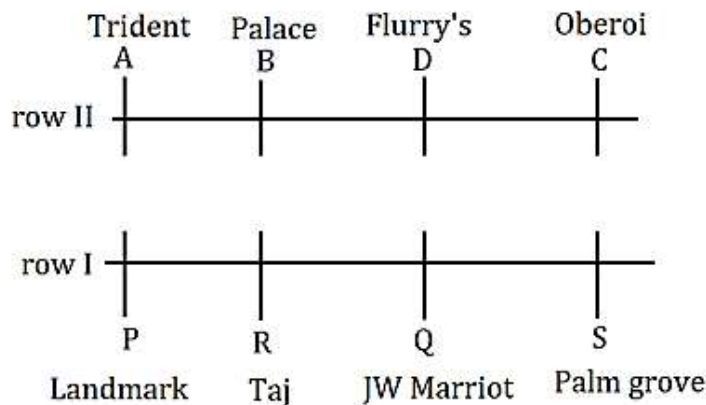

**S52. Ans.(b)**

**Sol.** From the given statements, P sits at one of the extreme end of row I. Two persons sit between P and the one who likes Palm grove. Q sits in row I and is not an immediate neighbor of P. R is an immediate neighbor of the one who likes Landmark and Q. Q does not like Landmark and does not sit at any of the extreme end. So, we have two possible cases:

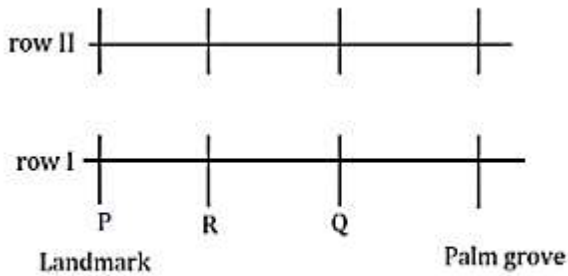

case-1

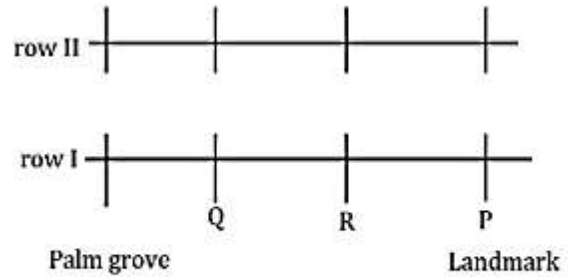

case-2

C sits in row II and is an immediate neighbor of the one who likes Flurry's. A who likes Trident sits second to the right of the one who like Flurry's. B sits immediately left of A. B likes Palace and sits in the same row as the one who likes Oberoi. The one who likes Taj sit second to the left of S. D faces the one who likes J W Marriot. Here Case 2 is ruled out now.

So, the final arrangement is:

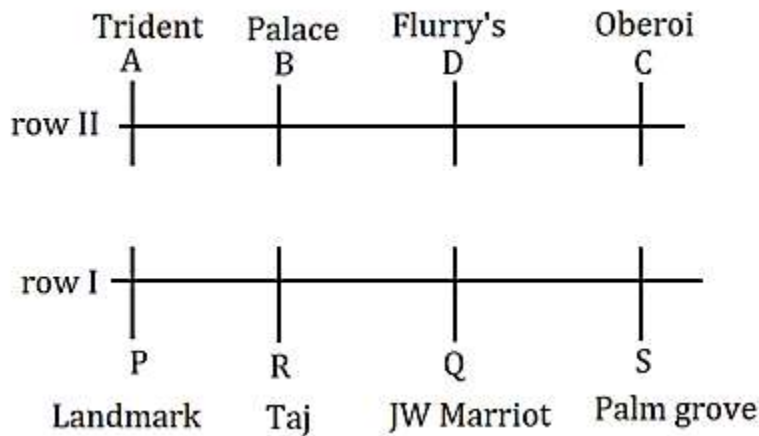

**S53. Ans.(b)**

**Sol.** From the given statements, P sits at one of the extreme end of row I. Two persons sit between P and the one who likes Palm grove. Q sits in row I and is not an immediate neighbor of P. R is an immediate neighbor of the one who likes Landmark and Q. Q does not like Landmark and does not sit at any of the extreme end. So, we have two possible cases:

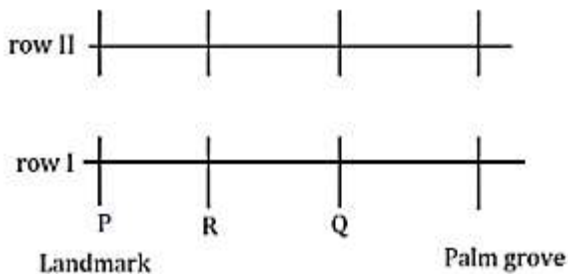

case-1

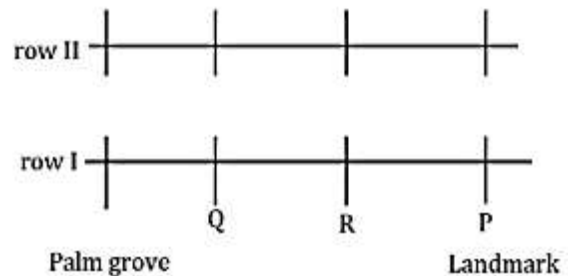

case-2

C sits in row II and is an immediate neighbor of the one who likes Flurry's. A who likes Trident sits second to the right of the one who like Flurry's. B sits immediately left of A. B likes Palace and sits in the same row as the one who likes Oberoi. The one who likes Taj sit second to the left of S. D faces the one who likes J W Marriot. Here Case 2 is ruled out now.

So, the final arrangement is:



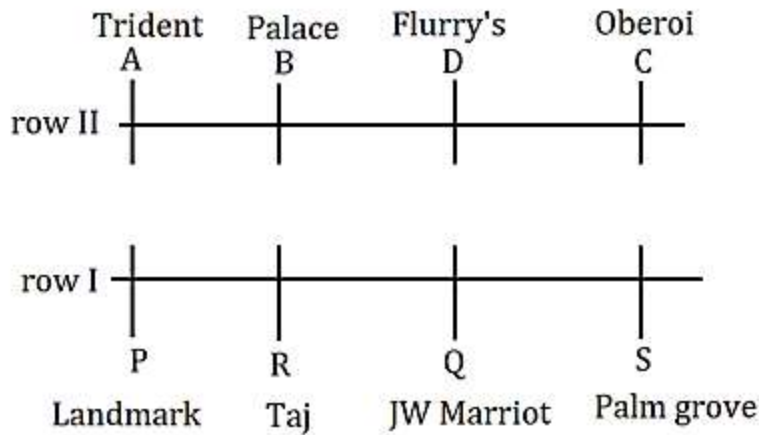

**S54. Ans.(c)**

**Sol.**

From the given statements, P sits at one of the extreme end of row I. Two persons sit between P and the one who likes Palm grove. Q sits in row I and is not an immediate neighbor of P. R is an immediate neighbor of the one who likes Landmark and Q. Q does not like Landmark and does not sit at any of the extreme end. So, we have two possible cases:

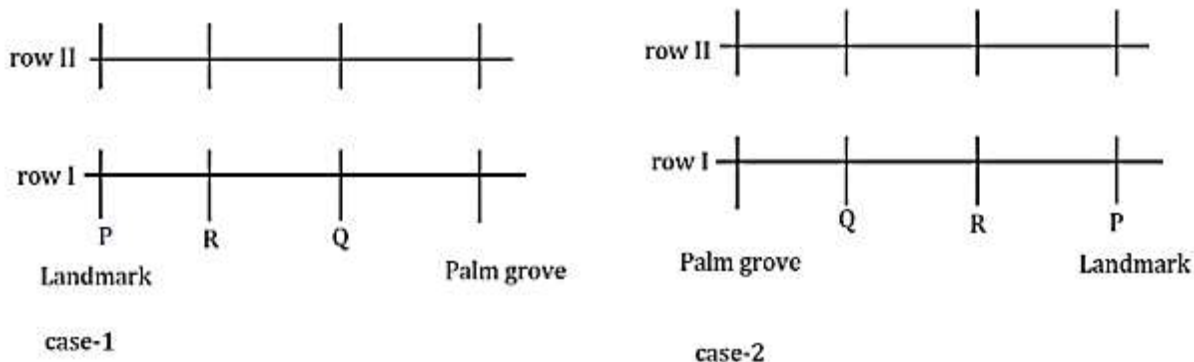

C sits in row II and is an immediate neighbor of the one who likes Flurry's. A who likes Trident sits second to the right of the one who like Flurry's. B sits immediately left of A. B likes Palace and sits in the same row as the one who likes Oberoi. The one who likes Taj sit second to the left of S. D faces the one who likes J W Marriot. Here Case 2 is ruled out now.

So, the final arrangement is:

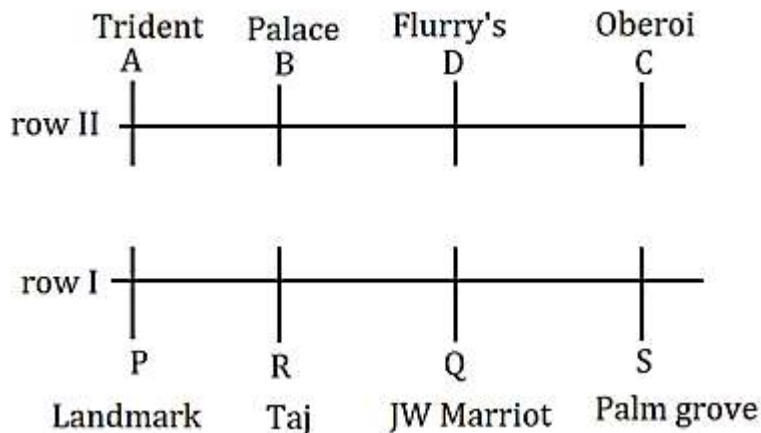

TEST SERIES

**Bilingual**

Video Solutions

**SBI PO 2020**

**PRIME**

135+ TOTAL TESTS | eBOOKS

Validity : 12 Months

**S55. Ans.(d)**

**Sol.** From the given statements, P sits at one of the extreme end of row I. Two persons sit between P and the one who likes Palm grove. Q sits in row I and is not an immediate neighbor of P. R is an immediate neighbor of the one who likes Landmark and Q. Q does not like Landmark and does not sit at any of the extreme end. So, we have two possible cases:

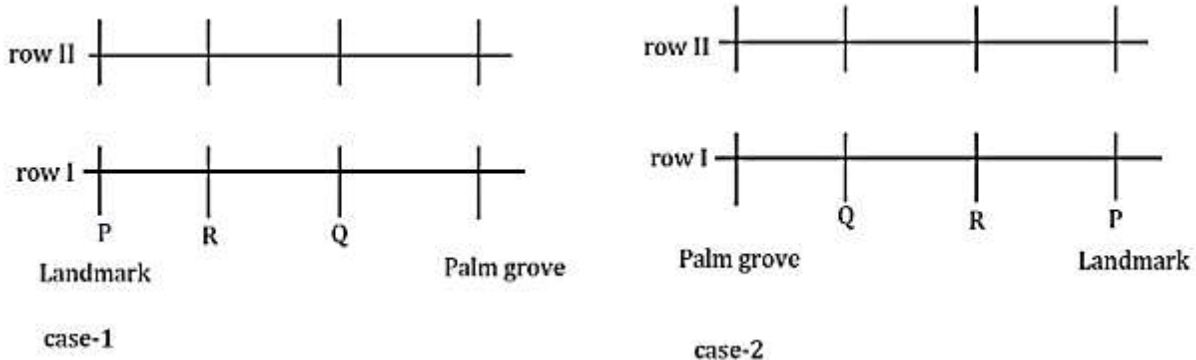

C sits in row II and is an immediate neighbor of the one who likes Flurry's. A who likes Trident sits second to the right of the one who like Flurry's. B sits immediately left of A. B likes Palace and sits in the same row as the one who likes Oberoi. The one who likes Taj sit second to the left of S. D faces the one who likes J W Marriot. Here Case 2 is ruled out now.

So, the final arrangement is:

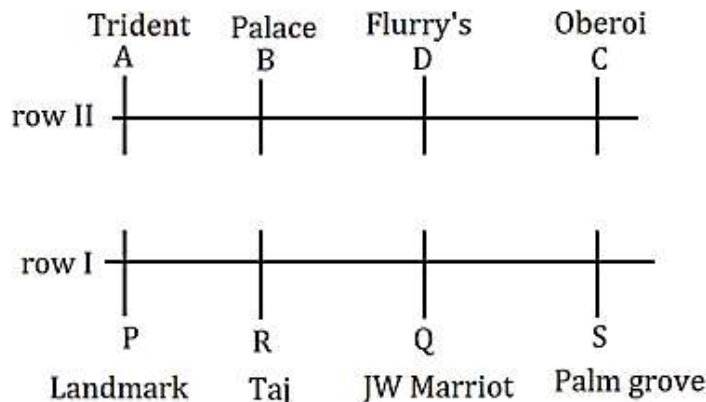

**S56. Ans.(c)**

**Sol.** byte is an eight digit binary number.

**S57. Ans.(d)**

**Sol.** Logic:

Words: The words are arranged according to the alphabetical order of the last letter of the word from the right end from right to left.

Numbers: The sum of the digits with in the number are arranged in descending order from the left end from left to right.

**Input: 29 hope 59 height 89 hamper 99 hotel 39 horn**

Step I: 18 29 59 height 89 hamper hotel 39 horn hope

Step II: 17 18 29 59 height hamper 39 horn hope hotel

Step III: 14 17 18 29 height hamper 39 hope hotel horn

Step IV: 12 14 17 18 29 height hope hotel horn hamper

Step V: 11 12 14 17 18 hope hotel horn hamper height

**S58. Ans.(a)****Sol.** Logic:

Words: The words are arranged according to the alphabetical order of the last letter of the word from the right end from right to left.

Numbers: The sum of the digits with in the number are arranged in descending order from the left end from left to right.

**Input: 29 hope 59 height 89 hamper 99 hotel 39 horn**

Step I: 18 29 59 height 89 hamper hotel 39 horn hope

Step II: 17 18 29 59 height hamper 39 horn hope hotel

Step III: 14 17 18 29 height hamper 39 hope hotel horn

Step IV: 12 14 17 18 29 height hope hotel horn hamper

Step V: 11 12 14 17 18 hope hotel horn hamper height

**S59. Ans.(b)****Sol.** Logic:

Words: The words are arranged according to the alphabetical order of the last letter of the word from the right end from right to left.

Numbers: The sum of the digits with in the number are arranged in descending order from the left end from left to right.

**Input: 29 hope 59 height 89 hamper 99 hotel 39 horn**

Step I: 18 29 59 height 89 hamper hotel 39 horn hope

Step II: 17 18 29 59 height hamper 39 horn hope hotel

Step III: 14 17 18 29 height hamper 39 hope hotel horn

Step IV: 12 14 17 18 29 height hope hotel horn hamper

Step V: 11 12 14 17 18 hope hotel horn hamper height

**S60. Ans.(c)****Sol.** Logic:

Words: The words are arranged according to the alphabetical order of the last letter of the word from the right end from right to left.

Numbers: The sum of the digits with in the number are arranged in descending order from the left end from left to right.

**Input: 29 hope 59 height 89 hamper 99 hotel 39 horn**

Step I: 18 29 59 height 89 hamper hotel 39 horn hope

Step II: 17 18 29 59 height hamper 39 horn hope hotel

Step III: 14 17 18 29 height hamper 39 hope hotel horn

Step IV: 12 14 17 18 29 height hope hotel horn hamper

Step V: 11 12 14 17 18 hope hotel horn hamper height

S61. Ans. (b)

Sol.

$$\frac{\frac{2600}{65}}{8} \times 136 \times \frac{45}{51} \times \frac{1}{80} = ?$$

$$? = 7.5$$

S62. Ans. (e)

Sol.

$$1008 \times \frac{18}{4} \times \frac{25}{126} \times \frac{32}{24} \times \frac{18}{96} = 15 \times ?$$

$$? = \frac{225}{15}$$

$$? = 15$$

S63. Ans. (a)

Sol.

$$\left(\frac{66}{100} \times 6500\right) - \left(\frac{80}{100} \times 4400\right) = ?$$

$$4290 - 3520 = ?$$

$$? = 770$$

S64. Ans. (c)

Sol.

$$2268 - \frac{?}{100} \times 4000 = 468$$

$$\frac{?}{100} \times 4000 = 1800$$

$$? = 45$$

S65. Ans. (d)

Sol.

$$2415 - \left(1760 \times \frac{150}{100} \times 380 \times \frac{1}{456}\right) = ?$$

$$? = 2415 - 2200$$

$$? = 215$$

S66. Ans(e)

Sol.

Total work = 120 units (LCM of days taken by Anurag, Bhavya and Chiru)

$$\text{Efficiency of Anurag} = \frac{120}{20} = 6 \text{ units/day}$$

$$\text{Efficiency of Bhavya} = \frac{120}{24} = 5 \text{ units/day}$$

$$\text{Efficiency of Chiru} = \frac{120}{30} = 4 \text{ units/day}$$

For minimum number of days = (Anurag + Bhavya)

work for first day and Chiru work for second day

Total work completed in two days = (6 + 5) + 4 = 15 units

Total minimum number of required days =  $\frac{120}{15} \times 2 = 16 \text{ days}$



S67. Ans(e)

Sol.

$$\text{Marked price of watch} = \frac{P \times (100+a)}{100}$$

$$\text{Selling price of watch} = P \times \frac{(100+a)}{100} \times \frac{(100-d)}{100}$$

ATQ,

$$P \times \frac{(100+a)}{100} \times \frac{100-d}{100} = P$$

$$\Rightarrow (100 + a) (100 - d) = 100 \times 100 \quad \dots(i)$$

And,

$$2d = a \quad \dots(ii)$$

From (i) & (ii)

$$d = 50\%$$

$$\text{So, } 2d = 100\%$$

S68. Ans(d)

Sol.

Let, the length of plot be ' $\ell$ ' mtr and breadth be ' $b$ ' mtr.

$$\text{Then, } \ell b = 120 \quad \dots(i)$$

$$\text{And } (\ell + 4)(b + 4) = 224 \quad \dots(ii)$$

Solving (i) and (ii)

$$\ell + b = 22 \quad \dots(iii)$$

Solving (i) and (iii)

$$\ell = 12$$

$$b = 10$$

$$\text{Required percentage} = \frac{12-10}{10} \times 100 = 20\%$$



adda247

S69. Ans(b)

Sol.

Let length of train P be  $\ell$  meter

$$\text{Speed of train A} = \frac{(\ell+520)}{30}$$

Also, train cross a man so,

$$\text{Speed of train} = \frac{\ell}{14.4}$$

ATQ,

$$\frac{\ell}{14.4} = \frac{(\ell+520)}{30}$$

$$30\ell - 14.4\ell = 7488$$

$$15.6\ell = 7488$$

$$\ell = 480 \text{ meter}$$

$$\text{Speed of train P} = \frac{(520+480)}{14.4}$$

$$= \frac{100}{3} \text{ m/s}$$

Let length of train Q be ' $X$ ' meters

$$(120 - 96) \times \frac{5}{18} = \frac{(480+X)}{126}$$

$$X = 840 - 480$$

$$X = 360 \text{ meters}$$

S70. Ans(b)

Sol.

$$\begin{aligned} \text{Total present age of A, B \& C} &= 74 \times 3 - 2 \times 3 \\ &= 216 \text{ yrs} \end{aligned}$$

Let age of A & C be  $11a$  &  $9a$  respectively

ATQ

$$96 + 11a + 9a = 216$$

$$20a = 120$$

$$a = 6 \text{ years}$$

$$\text{Age of A} = 11 \times 6 = 66 \text{ yrs}$$

$$\text{Age of C} = 9 \times 6 = 54 \text{ yrs}$$

$$\text{Six years hence age of C} = 54 + 6 = 60 \text{ yrs}$$

$$\text{Present age of D} = \frac{60}{15} \times 14 - 8 = 48 \text{ yrs}$$

$$\text{Age of E} = 48 - 8 = 40 \text{ yrs}$$

$$\text{Age of F} = \frac{40}{5} \times 6 = 48 \text{ yrs}$$

$$\text{Required average age of C, D \& F} = \frac{54+48+48}{3} = \frac{150}{3} = 50 \text{ yrs}$$

S71. Ans.(b)

Sol.

$$\text{Let the cost price for shopkeeper R} = 4a$$

$$\text{Marked price for shopkeeper R} = 7a$$

$$\text{Selling price for shopkeeper R} = \text{Rs } (4a - 200)$$

ATQ,

$$4a - 200 = 7a - 1400$$

$$3a = 1200$$

$$a = 400$$

$$\text{Marked price for shopkeeper R} = 2800$$

S72. Ans.(a)

Sol.

Let the cost price for shopkeeper Q & T each be Rs  $x$

$$\text{Marked price for Q} = \text{Rs } 1.8x$$

$$\text{Marked price for T} = \text{Rs } 1.5x$$

ATQ,

$$1.8x - 1.5x = 600$$

$$\Rightarrow x = \text{Rs } 2000$$

$$\text{Required ratio} = \frac{1900}{1750} = 38 : 35$$



S73. Ans.(e)

Sol.

Let cost price for S be  $3y$

So, marked price for S be  $5y$

And, selling price for S =  $5y \times \frac{90}{100} \times \frac{80}{100} = \text{Rs } 3.6y$

ATQ,

$$0.6y = 300$$

$$\Rightarrow y = 500$$

Marked price for S = 2500 Rs.

Cost price for S = Rs 1500 Rs.

New selling price for S = 1875

$$\text{Required profit \%} = \frac{375}{1500} \times 100 = 25\%$$

S74. Ans.(c)

Sol.

Let the CP for P, Q and U be Rs  $3a$ ,  $2a$  and  $4a$  respectively.

Selling price for P =  $3a + 150$

Selling price for Q =  $2a + 250$

Selling price for U =  $(4a + 150)$

Marked price for U = Rs  $7a$

ATQ,

$$7a - (4a + 150) = 300$$

$$\Rightarrow 3a - 150 = 300$$

$$a = 150$$

Selling price for P =  $3 \times 150 + 150 = \text{Rs } 600$

Selling price for Q =  $2 \times 150 + 250 = \text{Rs } 550$

$$\text{Required \%} = \frac{550}{600} \times 100 = 91\frac{2}{3}\%$$

S75. Ans.(c)

Sol.

Let the marked price for R and T be Rs  $700x$  and  $600x$  respectively.

$$\text{Cost price for R} = \frac{700x}{7} \times 4 = 400x$$

$$\text{Cost price for T} = \frac{600x}{3} \times 2 = 400x$$

$$\text{Required difference} = (400x + 200) - (400x - 100) \\ = \text{Rs } 300$$

TEST SERIES  
Bilingual  
Video Solutions  
SBI PO 2020  
PRIME  
135+ TOTAL TESTS | eBOOKS  
Validity : 12 Months

**S76. Ans(e)**

**Sol.**

$$T = \frac{180 \times 18}{96 \times 5} = 6.75 \text{ sec}$$

$$L = 6.75 \times 2 \times 72 \times \frac{5}{18} = 270 \text{ meters}$$

$$\text{Quantity I} - 6.75 \times 8 = 54 \text{ sec}$$

$$\text{Quantity II} - \frac{270}{5} = 54 \text{ meters}$$

So, **Quantity I = Quantity II**

**S77. Ans.(b)**

**Sol.**

$$\text{Quantity I} - \frac{28}{x^2} - \frac{15}{x} + 2 = 0$$

$$\Rightarrow 2x^2 - 15x + 28 = 0$$

$$\Rightarrow 2x^2 - 8x - 7x + 28 = 0$$

$$2x(x - 4) - 7(x - 4) = 0$$

$$(2x - 7)(x - 4) = 0$$

$$x = \frac{7}{2}, 4$$

$$\text{Quantity II} - \frac{21}{y^2} + 2 = \frac{13}{y}$$

$$\Rightarrow 2y^2 - 13y + 21 = 0$$

$$\Rightarrow 2y^2 - 7y - 6y + 21 = 0$$

$$\Rightarrow y(2y - 7) - 3(2y - 7) = 0$$

$$(2y - 7)(y - 3) = 0$$

$$y = 3, \frac{7}{2}$$

So, **Quantity I  $\geq$  Quantity II**



**S78. Ans(e)**

**Sol.**

$$\text{Number of days taken by B} = \frac{126}{140} \times 100 = 90 \text{ days}$$

$$\text{Total work} = 630 \text{ units}$$

$$\text{Efficiency of A} = \frac{630}{126} = 5 \text{ units/day}$$

$$\text{Efficiency of B} = \frac{630}{90} = 7 \text{ units/day}$$

$$\text{Quantity I} - D = 630 \times \frac{4}{9} \times \frac{1}{12} = 23\frac{1}{3} \text{ days}$$

$$3D = 3 \times \frac{70}{3} = 70 \text{ days}$$

$$\text{Quantity II} - \text{Efficiency of C} = \frac{630}{30} - (5 + 7) = 9 \text{ units/day}$$

$$\text{Required days} = \frac{630}{9} \times \frac{2}{3} = \frac{140}{3} \text{ days}$$

So, **Quantity I > Quantity II**



**S79. Ans(b)****Sol.**

$$\begin{aligned} \text{Quantity I} - 4x^2 + 17x - 42 &= 0 \\ 4x^2 + 24x - 7x - 42 &= 0 \\ 4x(x + 6) - 7(x + 6) &= 0 \\ (4x - 7)(x + 6) &= 0 \\ x &= \frac{7}{4}, -6 \end{aligned}$$

$$\begin{aligned} \text{Quantity II} - y^2 + 21y + 90 &= 0 \\ y^2 + 15y + 6y + 90 &= 0 \\ y(y + 15) + 6(y + 15) &= 0 \\ (y + 6)(y + 15) &= 0 \\ y &= -6, -15 \end{aligned}$$

So, **Quantity I**  $\geq$  **Quantity II****S80. Ans(c)****Sol.**Let cost price of item =  $100x$ So, Marked price of item =  $160x$ And, selling price of item =  $126x$ 

$$160x \times \frac{(100-d)}{100} \times \frac{100-(d+2.5)}{100} = 126x$$

$$d = 10\%$$

**Quantity I** -  $x = +60$  &  $-60$ 

$$\text{Quantity II} - 160x \times \frac{(100-30)}{100} - 100x = 240$$

$$12x = 240$$

$$x = 20 \text{ Rs.}$$

Marked price of item =  $3200 \text{ Rs.}$ 

$$1\frac{7}{8}\% \text{ of marked price of item} = 3200 \times \frac{15}{8} \times \frac{1}{100} = 60 \text{ Rs.}$$

So, **Quantity I**  $\leq$  **Quantity II****S81. Ans.(a)****Sol.**Let total number of people working in May =  $100x$ So, total number of people working in June =  $200x$ 

$$\text{Total number of people working in April} = \frac{400x}{3}$$

$$\text{Total number of people working in March} = \frac{400x}{3} \times \frac{120}{100} = 160x$$

$$\text{Given, } 200x - 160x = 600$$

$$x = 15$$

Months	Total number of people working
March	2400
April	2000
May	1500
June	3000

Total work done by male in March  
=  $2400 \times \frac{30}{100} \times 6 \times 30 = 129,600$  units

Total work done by female in June  
=  $3000 \times \frac{40}{100} \times 6 \times 30 = 216,000$  units

Required % =  $\frac{129,000}{216,000} \times 100 = 60\%$

**S82. Ans.(d)**

**Sol.**

Let total number of people working in May =  $100x$

So, total number of people working in June =  $200x$

Total number of people working in April =  $\frac{400x}{3}$

Total number of people working in March =  $\frac{400x}{3} \times \frac{120}{100} = 160x$

Given,  $200x - 160x = 600$

$x = 15$

Months	Total number of people working
March	2400
April	2000
May	1500
June	3000

Required Ratio =  $\frac{3000 \times \frac{60}{100} \times 6 \times 30}{1500 \times \frac{60}{100} \times 6 \times 30} = 2:1$

**S83. Ans.(c)**

**Sol.**

Let total number of people working in May =  $100x$

So, total number of people working in June =  $200x$

Total number of people working in April =  $\frac{400x}{3}$

Total number of people working in March =  $\frac{400x}{3} \times \frac{120}{100} = 160x$

Given,  $200x - 160x = 600$

$x = 15$

Months	Total number of people working
March	2400
April	2000
May	1500
June	3000



Required average

$$\begin{aligned} &= \frac{1}{4} \left[ 2400 \times \frac{30}{100} \times 6 + 2000 \times \frac{25}{100} \times 6 + 1500 \times \frac{40}{100} \times 6 + 3000 \times \frac{60}{100} \times 6 \right] \\ &= \frac{6}{4} [720 + 500 + 600 + 1800] \\ &= \frac{3}{2} \times 3620 \\ &= 5430 \end{aligned}$$

**S84. Ans.(e)**

**Sol.**

Let total number of people working in May =  $100x$

So, total number of people working in June =  $200x$

Total number of people working in April =  $\frac{400x}{3}$

Total number of people working in March =  $\frac{400x}{3} \times \frac{120}{100} = 160x$

Given,  $200x - 160x = 600$

$x = 15$

Months	Total number of people working
March	2400
April	2000
May	1500
June	3000

ATQ,

$$\begin{aligned} \frac{1500 \times \frac{40}{100} \times \frac{80}{100} \times 6}{\left(1500 \times \frac{60}{100} + x\right) \times 6} &= \frac{2}{5} \\ \frac{480}{900 + x} &= \frac{2}{5} \\ x &= 300 \end{aligned}$$

**S85. Ans.(b)**

**Sol.**

Distance travelled by Veer in two hours =  $90 \times 2 = 180$  km

Now, distance between Veer and Anurag at 5 : 00 p.m.

=  $1080 - 180 = 900$  km

Time in which they meet each other =  $\frac{900}{90+110} = 4.5$  hours

Required time = 5:00 p.m.+ 4.5 hour = 9: 30 p.m.

**S86. Ans.(e)****Sol.**

ATQ -

$$\frac{2RX}{6X(R-5)} = \frac{5}{12}$$

$$5R - 4R = 25$$

$$R = 25\%$$

Now if we put value of R

$$\frac{50X}{120X} = \frac{5}{12}$$

So, we can't determine value of X

**S87. Ans.(d)****Sol.**

Let total type B rice in mixture = 5a kg

So, total type A rice in mixture =  $5a \times \frac{1.4}{100} = 7a$  kg

total type B rice in 120 kg mixture which is taken out

$$= 120 \times \frac{5a}{12a} = 50 \text{ kg}$$

total type A rice in 120 kg mixture which is taken out

$$= 120 \times \frac{7a}{12a} = 70 \text{ kg}$$

ATQ,

$$\frac{7a - 70}{5a - 50 + 120} = \frac{100}{900}$$

$$\frac{7a - 70}{5a + 70} = \frac{7}{9}$$

$$a = 40 \text{ kg}$$

Initial quantity of type A rice in mixture =  $40 \times 7$ 

$$= 280 \text{ kg}$$

**S88. Ans.(a)****Sol.**Let, S<sub>1</sub> series be x, (x + 3), (x + 6), (x + 9) and (x + 12)And, S<sub>2</sub> series be y, (y + 4), (y + 8) (y + 12) and (y + 16)

$$\text{Average of series } S_1 = \frac{x + (x+3) + (x+6) + (x+9) + (x+12)}{5}$$

$$= \frac{(5x+30)}{5}$$

$$= (x + 6)$$

$$\text{Average of series } S_2 = \frac{y + (y+4) + (y+8) + (y+12) + (y+16)}{5}$$

$$= \frac{(5y+40)}{5}$$

$$= (y + 8)$$



# IBPS CLERK MAINS

25 TOTAL TESTS

Validity : 12 Months

Also, given,

$$\frac{(x+6)}{(y+8)} = \frac{3}{4}$$

$$4x + 24 = 3y + 24$$

$$4x = 3y$$

$$y = \frac{4x}{3} \text{----- (i)}$$

Given,

$$x + y = 35 \text{----- (ii)}$$

From (i) & (ii) we get -

$$x = 15$$

$$\text{And, } y = \frac{4 \times 15}{3} = 20$$

S<sub>1</sub> series is 15, 18, 21, 24, 27

S<sub>2</sub> series is 20, 24, 28, 32, 36

Required difference = 36 - 18 = 18

**S89. Ans(a)**

**Sol.**

Let the speed of boat in still water be x km/hr and that of speed of current be y km/hr

ATQ

$$x + y - (x - y) = 14$$

$$y = 7 \text{ km/hr}$$

$$\frac{90}{x+7} - \frac{26}{x-7} = \frac{80}{60}$$

$$x = 20$$

$$D = (20 - 7) \times 8 = 104 \text{ km}$$

**S90. Ans.(d)**

**Sol.**

Let sum invested by Q = Rs A

Then sum invested by P = Rs (A - 200)

And sum invested by R = Rs (A + 400)

Then ratio of profit share of P, Q & R = (A - 200) × 4 : (A × 5) : (A + 400) × 6

$$\Rightarrow (4A - 800) : 5A : (6A + 2400)$$

Let total profit = (15A + 1600)p

ATQ

$$(4A - 800)p + 20\% \text{ of } (15A + 1600)p = 198\% \text{ of } (4A - 800)p$$

$$\Rightarrow A = 1200 \text{ Rs.}$$



**S91. Ans.(a)**

**Sol.**

Required average

$$= \frac{1}{3} \left[ 1800 \times \frac{25}{100} + 1400 \times \frac{15}{100} + 3300 \times \frac{30}{100} \right]$$
$$= \frac{1}{3} [450 + 210 + 990] = 550$$

**S92. Ans.(d)**

**Sol.**

$$\text{Number of valid voter's card from A} = 1800 \times \frac{75}{100} = 1350$$

$$\text{Total invalid voter's card from B and C together} = 2400 \times \frac{20}{100} + 1400 \times \frac{15}{100}$$
$$= 480 + 210 = 690$$

$$\text{Required Percentage} = \frac{1350 - 690}{690} \times 100$$
$$= 95.65 \approx 96\% \text{ more}$$

**S93. Ans.(c)**

**Sol.**

$$\text{Required ratio} = \frac{1600 \times \frac{60}{100}}{1400 \times \frac{15}{100} + 3300 \times \frac{20}{100}}$$
$$= \frac{960}{210 + 990} = \frac{960}{1200} = 4 : 5$$

**S94. Ans.(b)**

**Sol.**

$$\text{Required Percentage} = \frac{2400 \times \frac{20}{100}}{1600 \times \frac{40}{100}} \times 100 = 75\%$$

**S95. Ans.(e)**

**Sol.**

$$\text{Required difference} = 3300 \times \frac{70}{100} - 1400 \times \frac{85}{100}$$
$$= 2310 - 1190 = 1120$$

**S96. Ans.(a)**

**Sol.**

$$\text{Probability of selecting a bag} = \frac{1}{2}$$

$$\text{Required probability} = \frac{1}{2} \left( \frac{{}^{10}C_2}{{}^{15}C_2} + \frac{{}^{10}C_1 \times {}^5C_1}{{}^{15}C_2} \right) + \frac{1}{2} \left( \frac{{}^6C_2}{{}^{15}C_2} + \frac{{}^6C_1 \times {}^9C_1}{{}^{15}C_2} \right)$$

$$= \frac{1}{2} \left( \frac{45}{105} + \frac{50}{105} \right) + \frac{1}{2} \left( \frac{15}{105} + \frac{54}{105} \right)$$

$$= \frac{1}{2} \times \frac{95}{105} + \frac{1}{2} \times \frac{69}{105}$$

$$= \frac{95 + 69}{210} = \frac{164}{210} = \frac{82}{105}$$

**S97. Ans.(a)****Sol.**

$$\text{Total wheat produced by B} = \frac{15}{100} \times 600000 = 90000 \text{ tons}$$

$$\text{Total wheat sold by C and D together} = 600000 \left( \frac{9}{100} \times \frac{74}{100} + \frac{23}{100} \times \frac{64}{100} \right)$$

$$= 128280 \text{ tons}$$

$$\text{Required \%} = \frac{128280 - 90000}{90000} \times 100$$

$$= 42.53 \approx 42.5\%$$

**S98. Ans.(a)****Sol.**

$$\text{Total wheat sold by F} = 600000 \times \frac{21}{100} \times \frac{74}{100} = 93240 \text{ tons}$$

$$\text{Total wheat sold by D} = 600000 \times \frac{23}{100} \times \frac{64}{100} = 88320 \text{ tons}$$

$$\text{Required difference} = 4920 \text{ tons}$$

**S99. Ans.(c)****Sol.**

$$\text{Unsold wheat by A} = \frac{18}{100} \times 600000 \times \frac{18}{100} = 19440 \text{ tons}$$

$$\text{Unsold wheat by B} = 600000 \times \frac{15}{100} \times \frac{30}{100} = 27000 \text{ tons}$$

$$\text{Unsold wheat by F} = 600000 \times \frac{21}{100} \times \frac{26}{100} = 32760 \text{ tons}$$

$$\text{Required average} = \frac{19440 + 27000 + 32760}{3}$$

$$= 26400 \text{ tons}$$

**S100. Ans.(d)****Sol.**

$$\text{Total wheat produced by A, C \& E together} = \frac{41}{100} \times 600000$$

$$= 246000 \text{ tons}$$

$$\text{Total wheat sold by A, C \& E together} =$$

$$= \frac{18}{100} \times 600000 \times \frac{82}{100} + \frac{9}{100} \times \frac{74}{100} \times 600000 + \frac{14}{100} \times \frac{80}{100} \times 600000$$

$$= 195720 \text{ tons}$$

$$\text{Required \%} = \frac{195720}{246000} \times 100 = 79.56 \approx 80\%$$

**S101. Ans(c)****Sol.**

Let length of train be L meters and speed of train be S km/hr

$$\text{From statement 1, } L + 1080 = S \times \frac{5}{18} \times 75$$

$$L = \frac{125S - 6480}{6} \quad \dots\dots \quad (i)$$

$$\text{From statement 2, } L = (S - 12) \times \frac{5}{18} \times 25.2$$

$$L = (S - 12) \times 7 \quad \dots\dots \quad (ii)$$

From (i) and (ii), we get

$$\frac{125S - 6480}{6} = (S - 12) \times 7$$

$$125S - 6480 = 42S - 504$$

$$83S = 5976$$

$$S = 72 \text{ km/hr}$$

So, both the statements taken together are necessary to answer the question, but neither of the statements alone is sufficient to answer the question.

**S102. Ans(a)**

**Sol. From statement 1:** Let numerator of fraction be  $3x$

So, denominator will be  $5x$

$$\text{Fraction} = \frac{3}{5}$$

$$\text{Reqd value} = \frac{40}{100} \times \frac{3}{5} = \frac{6}{25}$$

**From statement 2:**

We don't know whether numerator is greater than denominator or denominator is greater than numerator. So, required value can't be determined.

Hence, statement **(1)** alone is sufficient to answer the question but statement **(2)** alone is not sufficient to answer the question.

**S103. Ans(c)**

**Sol.**

$$\text{Perimeter of a semi-circle} = \pi r + 2r$$

**From statement 1 and statement 2 together**

$$\text{Side of the square} = \sqrt{784} = 28 \text{ cm}$$

$$\text{Radius of semi-circle} = \frac{28}{2} = 14 \text{ cm}$$

$$\begin{aligned} \text{Perimeter of the semicircle} &= \left(\frac{22}{7} \times 14 + 2 \times 14\right) \text{cm} \\ &= 44 + 28 = 72 \text{ cm} \end{aligned}$$

Hence, both the statements taken together are necessary to answer the question, but neither of the statements alone is sufficient to answer the question.

**S104. Ans(e)**

**Sol.**

**From statement 1:**

$$\text{Required number of men (x)} = \frac{15 \times 160}{120} = 20$$

**From statement 2:** According to the question

$$x \times 120 = (x+4) \times 100$$

$$20x = 400$$

$$x = 20$$

Hence, either statement **(1)** or statement **(2)** by itself is sufficient to answer the question.

**S105. Ans(c)**

**Sol.** Let speed of boat in still water is  $x$  km/hr and speed of stream be  $y$  km/hr

TEST SERIES  
Bilingual  
Video Solutions  
SBI PO 2020  
PRIME  
135+ TOTAL TESTS | eBooks  
Validity : 12 Months



**From statement 1:**  $x = y + 6$

**From statement 2:**  $\frac{45}{x+y} + \frac{30}{x-y} = 10$

From (1) and (2), we get

$$\frac{45}{(y+6+y)} + \frac{30}{y+6-y} = 10$$

$$\frac{45}{2y+6} + \frac{30}{6} = 10$$

$$\frac{45}{2y+6} = 5$$

$$y = 1.5 \text{ km/hr}$$

$$x = 6 + 1.5 = 7.5 \text{ km/hr}$$

$$\begin{aligned} \text{Required ratio} &= \frac{48}{7.5 - 1.5} : \frac{45}{7.5} \\ &= 4:3 \end{aligned}$$

So, both the statements taken together are necessary to answer the question, but neither of the statements alone is sufficient to answer the question.

**S106. Ans(e)**

**Sol.**

$$\text{I. } 5x^2 - 23x + 5x - 23 = 0$$

$$(5x - 23)(x + 1) = 0$$

$$x = -1, \frac{23}{5}$$

$$\text{II. } 2y^2 + 19y - 2y - 19 = 0$$

$$(2y + 19)(y - 1) = 0$$

$$y = -\frac{19}{2}, 1$$

clearly, no relation can be established

**S107. Ans(a)**

**Sol.**

$$\text{I. } 7x^2 + 43x + 36 = 0$$

$$7x^2 + 36x + 7x + 36 = 0$$

$$(7x + 36)(x + 1) = 0$$

$$x = -\frac{36}{7}, -1$$

$$\text{II. } 14y^2 - 7y + 4y - 2 = 0$$

$$(2y - 1)(7y + 2) = 0$$

$$y = \frac{1}{2}, -\frac{2}{7}$$

clearly,  $x < y$



**S108. Ans(d)****Sol.**

$$\text{I. } 27x^2 = 81x - 54$$

$$x^2 - 3x + 2 = 0$$

$$(x - 2)(x - 1) = 0$$

$$x = 1, 2$$

$$\text{II. } y^2 = 1$$

$$y = -1, 1$$

clearly,  $x \geq y$

**S109. Ans(e)****Sol.**

$$\text{I. } x^2 - 15\sqrt{2}x - 6\sqrt{2}x + 180 = 0$$

$$(x - 15\sqrt{2})(x - 6\sqrt{2}) = 0$$

$$x = 6\sqrt{2}, 15\sqrt{2}$$

$$\text{II. } y^2 + 12\sqrt{3}y - 5\sqrt{3}y - 180 = 0$$

$$(y + 12\sqrt{3})(y - 5\sqrt{3}) = 0$$

$$y = 5\sqrt{3}, -12\sqrt{3}$$

clearly, no relation can be established

**S110. Ans(c)****Sol.**

$$\text{II. } y^2 + 16y - 57 = 0$$

$$(y + 19)(y - 3) = 0$$

$$y = 3, -19$$

$$\text{I. when } y = 3$$

$$x = 36 - 13 = 23$$

$$\text{when } y = -19$$

$$x = 1431$$

clearly,  $x > y$

**S111. Ans. (e)**

**Sol.** To validate the answer, refer to the second paragraph, which mentions, “*The good is linked to historic terms, a key example being the India-U.S. civil nuclear deal, the ongoing defence cooperation of the past decade worth billions of dollars and the signing of three “foundational defence agreements”, i.e. the Communications Compatibility and Security Agreement, the Logistics Exchange Memorandum of Agreement and the Basic Exchange and Cooperation Agreement for Geo-spatial Cooperation.*” From the quoted text, we can infer that all the given statements are correct in context of the

**S112. Ans. (e)**

**Sol.** To validate the answer, refer to the 4<sup>th</sup> paragraph of the passage given above, which mentions, “*First, the recent and abrupt abandonment by the Trump administration of the Kurds who assisted the Americans in fighting the Islamic State both in terms of resources and manpower should serve as a warning sign to India in terms of its Afghanistan strategy.*” From the quoted text, we can infer that the statement mentioned in option (e) is correct in context of the given question. Hence, option (e) is the most suitable answer choice.

**S113. Ans. (c)**

**Sol.** in context of the given passage, only the phrase given in option (c) is correct and makes the statement grammatically correct and complete. Hence, option (c) is the most suitable answer choice.

**S114. Ans. (b)**

**Sol.** To validate the answer, refer to the 4<sup>th</sup> paragraph, which mentions, *“The current Indian dispensation must prepare for the eventuality of a sudden withdrawal of U.S. forces from Afghanistan which could lead to a complete takeover by the Taliban, with potential repercussions on India’s northern front.”* From the quoted text, we can infer that the statements (i) and (ii) are correct in context of the given question. Hence, option (b) is the most suitable answer choice.

**S115. Ans. (d)**

**Sol.** to validate the answer, refer to the second paragraph, which mentions, *“But one domain of foreign policy which requires a serious relook is the India-U.S. relationship because the backstage reality of a no-trade deal, and continuing U.S.-Pakistan bonhomie, among other irritants, have taken the wind out of the sails of the friendship between the leaders of the two nations as seen at the recent “Howdy Modi” event in Houston.”* From the quoted text, we can infer that the statements given in options (b) and (c) are correct in context of the given question. Hence, option (d) is the most suitable answer choice.

**S116. Ans. (d)**

**Sol.** In all the three blanks, only ‘inherent’ can fit in to make the statements grammatically correct and contextually meaningful. Hence, option (d) is the most suitable answer choice.

Smother: kill (someone) by covering their nose and mouth so that they suffocate

Invigorate: give strength or energy to

Reprimand: a formal expression of disapproval

**S117. Ans. (b)**

**Sol.** Among the given words, ‘trifling’ is opposite to ‘crucial’. Hence, option (b) is the most suitable answer choice.

fettered- restrained with chains or manacles, typically around the ankles

subservient- prepared to obey others unquestioningly

effete- affected, over-refined, and ineffectual.

**S118. Ans. (c)**

**Sol.** among the given words, ‘efficacious’ is synonymous with ‘effective’. Hence, option (c) is the most suitable answer choice.

Unconscionable: unreasonable; unscrupulous; excessive

Errant: to be wandering; not sticking to a circumscribed path

Disparate: two things are fundamentally different

**S119. Ans. (d)**

**Sol.** To validate the answer, refer to the third paragraph of the passage given above, which mentions, *“The arrival of OTT platforms in India has introduced audiences to a class of visual entertainment not seen before. Shows like Breaking Bad and Chernobyl are different from the best of television earlier (The Sopranos, for example). They are hyper-realistic*



and give a credible sense of the actual space in which the action might have actually taken place, once considered impossible on TV.” From the quoted text, we can infer that the statements given in options (a) and (b) are appropriate in context of the given passage. Hence, option (d) is the most suitable answer choice.

**S120. Ans. (e)**

**Sol.** To validate the answer, refer to the first paragraph of the passage given above, which mentions, “*This cinema was meant to talk about the lives of ordinary people. Given this intent, other films financed by governmental agencies also emerged, the films of Hrishikesh Mukherjee, Shyam Benegal, Govind Nihalani and Basu Chatterjee. But this cinema lost ground eventually, as it was dependent on state patronage and screening on Doordarshan to recover even meagre costs.*” From the quoted text, we can infer that the statements given in options (a) and (c) are appropriate in context of the given passage. Hence, option (e) is the most suitable answer choice.

**S121. Ans. (e)**

**Sol.** To validate the answer, refer to the third paragraph of the passage given above, which mentions, “*A fundamental fact about Indian films that is not acknowledged is that they do not quite fit into the world cinema paradigm. Indian cinema has a strange grammar that is perhaps not even recognised as it should be. Indian cinema’s invincibility on its own turf — when better established cinemas have succumbed to Hollywood — as well as Indian art cinema’s inability to make a mark internationally in relation to newcomers like Turkey, Iran and South Korea — testifies to this.*” From the quoted text, we can infer that the statements given in options (a), (b) and (c) are correct as per the context of the question. Hence, option (e) is the most suitable answer choice.

**S122. Ans. (d)**

**Sol.** To validate the answer, refer to the last lines, which mention, “*Films on Netflix and Amazon Prime get reviewed in the media and opportunities are opening up. Directors working on low budgets can experiment, although experimentation still implies being able to hold the attention of an audience; it does not mean ‘avant-garde’. With a new kind of cinema, new kinds of actors and technicians are emerging. This means that small budget cinema has entered a new age.*” Referring to the quoted text, we can infer that the statement given in option (b) is the outcome and not the reason for the growth. Hence, option (d) is the most suitable answer choice.

**S123. Ans. (a)**

**Sol.** To validate the answer, refer to the second paragraph, which mentions, “*This brief history is significant today as over-the-top (OTT) portals (Amazon Prime and Netflix, for instance) are assisting in the dissemination of films made with low budgets that cannot hope to get public exhibition in cinema halls.*” From the quoted text, we can infer that the statement given in option (a) is appropriate in context of the given passage. Hence, option (a) is the most suitable answer choice.

**S124. Ans. (b)**

**Sol.** As per the context of the given passage, only the phrase given in option (b), ‘*artistic freedom available to young filmmakers*’, could make the statement grammatically correct and complete. Hence, option (b) is the most suitable answer choice.

**S125. Ans. (d)**

**Sol.** Among the given words, only 'discerned' is synonymous with 'perceived'. Hence, option (d) is the most suitable answer choice.

Perceived: become aware or conscious of (something); come to realize or understand.

disgorge: pour (something) out

relinquish: voluntarily cease to keep or claim; give up.

abdicate: (of a monarch) renounce one's throne

**S126. Ans. (b)**

**Sol.** Among the given words, only 'assent', which indicates 'the expression of approval' could fit in both the blanks to make the statement grammatically and contextually meaningful. Hence, option (b) is the most suitable answer choice.

Atonement- the action of making amends for a wrong or injury

Altercate- dispute or argue noisily and publicly

**S127. Ans. (d)**

**Sol.** In both the blanks, 'Specious' which means '*superficially plausible, but actually wrong*', can fit in perfectly to make the statement grammatically correct and contextually meaningful. Hence, option (d) is the most suitable answer choice.

Coveted- greatly desired or envied

Corporeal- relating to a person's body, especially as opposed to their spirit

Indigent- poor/ needy

**S128. Ans. (c)**

**Sol.** Among the given words, 'impediment', which indicates 'a hindrance or obstruction in doing something', fits perfectly in both the statements.

Prudence- the quality of being prudent; cautiousness

Concord- agreement or harmony between people or groups

Fidelity- faithfulness to a person, cause, or belief, demonstrated by continuing loyalty and support

Indignity- treatment or circumstances that cause one to feel shame or to lose one's dignity

**S129. Ans. (e)**

**Sol.** Among the given words, 'gloomy', which indicates 'dark or poorly lit, especially so as to appear depressing or frightening', fits perfectly in both the statements.

Melodious- relating to or characterized by melody

Frugal- sparing or economical as regards money or food

Indiscreet- having, showing, or proceeding from too great a readiness to reveal things that should remain private or secret

Lax- not sufficiently strict, severe, or careful

**S130. Ans. (c)**

**Sol.** In both the blanks, 'strenuous' which means 'requiring or using great effort or exertion', can fit in perfectly to make the statement grammatically correct and contextually meaningful. Hence, option (d) is the most suitable answer choice.

Lucid- expressed clearly; easy to understand

Sporadic- occurring at irregular intervals or only in a few places; scattered or isolated

Ungainly- (of a person or movement) awkward; clumsy

Gregarious- (of a person) fond of company; sociable

**S131. Ans. (a)**

**Sol.** In the given blank, both 'fragile' and 'vulnerable' could fit in the given blank to make the statement grammatically and contextually meaningful. Hence, option (a) is the most suitable answer choice.

Fragile- easily destroyed or threatened

supercilious: behaving or looking as though one thinks one is superior to others.

saturnine: (of a person or their manner) gloomy.

contentious: causing or likely to cause an argument; controversial.

overweening: showing excessive confidence or pride.

untoward: unexpected and inappropriate or inconvenient.

artless: without effort or pretentiousness; natural and simple.

**S132. Ans. (e)**

**Sol.** In the given blank, both 'grim' and 'dreadful' could fit in the given blank to make the statement grammatically and contextually meaningful. Hence, option (e) is the most suitable answer choice.

Grim: very serious or gloomy

Dreadful: causing or involving great suffering, fear, or unhappiness; extremely bad or serious

Deluged: inundate with a great quantity of something

Swamping: overwhelm or flood with water.

Deleterious: causing harm or damage

Opportune: (of a time) especially convenient or appropriate for a particular action or event

Disdainful: showing contempt or lack of respect

**S133. Ans. (c)**

**Sol.** In the given blank, both 'accumulation' and 'build-up' could fit in the given blank to make the statement grammatically and contextually meaningful. Hence, option (c) is the most suitable answer choice.

Accumulation: the acquisition or gradual gathering of something

Glee: great delight, especially from one's own good fortune or another's misfortune

Exhilaration: a feeling of excitement, happiness, or elation

Gaiety: the state or quality of being light-hearted or cheerful

Depraved: morally corrupt; wicked.

Reprobate: unprincipled.

Roguish: characteristic of a dishonest or unprincipled person

**S134. Ans. (b)**

**Sol.** In the given blank, both 'eternal' and 'immutable' could fit in the given blank to make the statement grammatically and contextually meaningful. Hence, option (b) is the most suitable answer choice.

Immutable: unchanging over time or unable to be changed

Stymied: prevent or hinder the progress of

subdued: (of a person or their manner) quiet and rather reflective or depressed

Coaxed: gently and persistently persuade (someone) to do something

Emboldened: give (someone) the courage or confidence to do something

Dispirited: having lost enthusiasm and hope; disheartened

Morphed: undergo or cause to undergo a gradual process of transformation.

TEST SERIES  
Bilingual  
VIDEO SOLUTIONS  
IBPS CLERK  
MAINS  
25 TOTAL TESTS  
Validity : 12 Months

**S135. Ans. (e)**

**Sol.** In the given blank, both 'plundered' and 'thieved' could fit in the given blank to make the statement grammatically and contextually meaningful. Hence, option (e) is the most suitable answer choice.

Plundered- steal goods from (a place or person), typically using force and in a time of war or civil disorder

Attenuated- having been reduced in force, effect, or value

Encapsulated- express the essential features of (something) succinctly

Lubricated- apply a substance such as oil or grease to (an engine or component) so as to minimize friction and allow smooth movement

**S136. Ans. (c)**

**Sol.** In the given blank, both 'breathtaking' and 'astounding' could fit in the given blank to make the statement grammatically and contextually meaningful. Hence, option (c) is the most suitable answer choice.

Astounding- surprisingly impressive or notable

Prodigious- remarkably or impressively great in extent, size, or degree

Exhilaration- a feeling of excitement, happiness, or elation

Pernicious- having a harmful effect, especially in a gradual or subtle way

**S137. Ans. (b)**

**Sol.** Among the given phrases, only the phrase given in option (b) 'each other's development opportunities rather than threats' is the most appropriate phrase that could make the statement grammatically and contextually correct. The passage mentions the meeting held between Indian PM and Chinese President, where the discussion was held regarding India-China cooperation and seeing each other as development partners. Hence, option (b) is the most suitable answer choice.

**S138. Ans. (c)**

**Sol.** among the given phrases, we will eliminate option (a) as latter part of the phrase, when joined with the part of the statement, given after the blank, does not make the statement contextually meaningful. Similar is the case with option (d). Also, "ICJ's Pakistan" is an incorrect phrase, therefore we will eliminate option (b). Going further, only the phrase given in option (c) can make the paragraph contextually meaningful and grammatically correct. Hence, option (c) is the most suitable answer choice.

**S139. Ans. (d)**

**Sol.** Here, option (a) will be eliminated because of the error of tense. The phrase given in option (b) will make an incomplete statement and will therefore be omitted. Going further, only the phrase given in option (d) makes the statement grammatically correct and contextually meaningful. Hence, option (d) will be the most suitable answer choice.

**S140. Ans. (b)**

**Sol.** Among the given phrases, only the phrase given in option (b) 'has been managed anywhere in the world' is the most appropriate phrase that could make the statement grammatically and contextually correct. Hence, option (b) is the most suitable answer choice.

**S141. Ans. (e)**

**Sol.** Among the given options, none of the given phrases fit in the given blank. We will omit options (a) and (b) because they do not form meaningful statement. Also, we will eliminate the phrase given in option (d) because here the use of "lead" is incorrect. Hence, option (e) is the most suitable answer choice.

**S142. Ans. (c)**

**Sol.** Here, we will eliminate option (a) and (b) as they do not form a meaningful statement when joined with the former part of the statement, given before the blank. Only the phrase given in option (c) can make the statement grammatically correct and contextually meaningful. Hence, option (c) is the most suitable answer choice.

**S143. Ans. (b)**

**Sol.** Among the given highlighted words, the correct arrangement of words will be **DCBA**. Also, the word, 'spectrum' must be replaced with 'speculative'. Hence, option (c) is the most suitable answer choice.

**S144. Ans. (d)**

**Sol.** Among the given highlighted words, the correct arrangement of words will be **CADB**. Also, none of the highlighted words is contextually or grammatically incorrect. Hence, option (d) is the most suitable answer choice.

**S145. Ans. (e)**

**Sol.** All the highlighted words are at their correct positions. Also, they do not require any improvement. Hence, option (e) is the most suitable answer choice.

**S146. Ans. (c)**

**Sol.** Among the given highlighted words, the correct arrangement of words will be **DABC**. Also, the word 'integrity' must be replaced with 'implications'. Hence, option (c) is the most suitable answer choice.

**S147. Ans. (c)**

**Sol.** Among the given highlighted words, the correct arrangement of words will be **BADC**. Also, the word, 'spectrum' must be replaced with 'speculative'. Hence, option (c) is the most suitable answer choice.

**S148. Ans. (b)**

**Sol.** Here, the error lies in statement given in option (b), where there is an error of phrasal verb. Here, "drop up" which means "to visit a place that is north of one's current location" will be replaced with "drop back" which means "fall back or get left behind". Hence, option (b) is the most suitable answer choice.

**S149. Ans. (d)**

**Sol.** There is error in the statement given in option (d). The use of 'demanding' in the option (d) is incorrect as per the rule of parallelism. Here, 'demanding' should be replaced with 'demanded'. Hence, option (d) is the most suitable answer choice.

**S150. Ans. (d)**

**Sol.** There is a grammatical error in sentence (d). To make the sentence grammatically correct, replace "was" by "is", since the event described is of present. The hint can be drawn from the word "today". Hence, option (d) is the most suitable answer choice.

**S151. Ans.(a)**

**Sol.** Pradhan Mantri Awas Yojana is an initiative by Government of India in which affordable housing will be provided to the urban poor with a target of building 20 million affordable houses by 31 March 2022.



**S152. Ans.(c)**

**Sol.** The financial assistance of loans of Rs. 10000 by a bank to very a small borrower is called Microfinance.

**S153. Ans.(d)**

**Sol.** The Finance Minister Nirmala Sitharaman announced that Non-banking financial companies will be permitted to use the Aadhaar based bank mandated KYC to avoid repeating the process for the customers. NBFCs to be permitted to use Aadhaar authenticated bank KYC to avoid repeated processes.

**S154. Ans.(a)**

**Sol.** A debit card is a plastic payment card that can be used instead of cash when making purchases. It is similar to a credit card, but unlike a credit card, the money comes directly from the user's bank account when performing a transaction.

**S155. Ans.(d)**

**Sol.** The Union Cabinet gave its ex-post facto approval to the memorandum of understanding (MoU) between the Reserve Bank and the Central Bank of United Arab Emirates (UAE) on co-operation on currency swap agreement.

**S156. Ans.(b)**

**Sol.** The Reserve Bank of India will allow large modern currency chests to increase the service charges on cash deposited by non-chest bank branches from the existing rate of ₹5 per packet of 100 pieces to a higher rate subject to a maximum of ₹8 per packet.

**S157. Ans.(b)**

**Sol.** Mobile Money Transfer (MMTS) is a service that enables instant money transfer from one place to another place using mobile, through Indian post offices. The consumer just needs to have a mobile while the actual transmission of the money is initiated by the Postal Assistant, using his/her special handset.

**S158. Ans.(b)**

**Sol.** Mr. Amitabh Kant is presently CEO of National Institution for Transforming India (NITI)

**S159. Ans.(b)**

**Sol.** Public Sector Banks (PSBs) are banks where a majority stake (i.e. more than 50%) is held by a government. The shares of these banks are listed on stock exchanges.

**S160. Ans.(b)**

**Sol.** The Finance Ministry has set up a Public Debt Management Cell (PDMC) with a view to streamline government borrowings and better cash management with the overall objective of deepening bond markets.



**S161. Ans.(b)**

**Sol.** The Reserve Bank of India (RBI) constituted a committee to review the existing state of mortgage securitization in India and suggest measures to deepen it. The six-member committee on the development of housing finance securitization market, headed by Bain & Co Senior Advisor Harsh Vardhan, has also been asked to assess the role of various counterparties, including the servicers, trustees, rating agencies, in the securitization process and suggest measures required.

The panel would also suggest specific measures for facilitating secondary market trading in mortgage securitization instruments, such as broadening investor base, and strengthening market infrastructure.

**S162. Ans.(a)**

**Sol.** Low liquidity in the economy.

**S163. Ans.(d)**

**Sol.** Dr. Rabi N. Mishra has been elevated as executive director in the Reserve Bank of India.

**S164. Ans.(b)**

**Sol.** The Reserve Bank of India (RBI) allowed Bank of China to offer regular banking services in the country.

**S165. Ans.(a)**

**Sol.** The Reserve Bank of India launched an application on its website for lodging complaints against banks and NBFCs with a view to improve customer experience in timely redressal of grievances. The Complaint Management System (CMS) is a software application to facilitate RBI's grievance redressal process.

**S166. Ans.(a)**

**Sol.** The Nobel Peace Prize for 2019 has been awarded to Ethiopian Prime Minister Abiy Ahmed Ali for "his efforts to achieve peace and international cooperation, and in particular for his decisive initiative to resolve the border conflict with neighbouring Eritrea."

**S167. Ans.(a)****S168. Ans.(c)**

**Sol.** Indian depository receipt is an instrument in the form of depository receipt created by an Indian depository against underlying equity shares of the issuing company.

**S169. Ans.(d)**

**Sol.** SEBI is the regulator of the credit rating agencies in India.

**S170. Ans.(c)****S171. Ans.(d)**

**Sol.** The Union Ministry of Micro, Small and Medium Enterprises (MSME) approved a proposal by the Khadi and Village Industries Commission (KVIC) to increase the wages of artisans by over 36 percent.

**S172. Ans.(b)**

**Sol.** A contingent beneficiary is specified by an insurance contract holder who receive the benefits if the primary beneficiary has died at the time the benefit is to be paid.

**S173. Ans.(a)**

**Sol.** Convertible Insurance is a type of life insurance that allows the policyholder to change a term policy into a whole or universal policy without going through the health qualification process again.

**S174. Ans.(d)**

**Sol.** The Cabinet has given its nod to turn the Pradhan Mantri JanDhan Yojana (PMJDY) into an open-ended scheme with higher insurance cover and double the overdraft (OD) facility. The PMJDY has been a success and the Centre has decided to make it open ended, with the OD limit increased to Rs.10,000 from the existing Rs. 5,000.

**S175. Ans.(a)**

**Sol.** The government doubled the pecuniary limit to Rs 20 lakh for filing loan recovery application in the Debt Recovery Tribunals (DRT) by banks and financial institutions.

**S176. Ans.(b)**

**Sol.** Commercial coverage against losses resulting from the failure of business debtors to pay their obligation to the insured, usually due to insolvency.

**S177. Ans.(c)**

**Sol.** Digital payments facilitator PayU has acquired US-based financial technology firm Wibmo for \$70 million (about Rs 484 crore), that will help the company scale-up its business. Under the agreement, PayU and Wibmo businesses will continue to run separately.

**S178. Ans.(a)**

**Sol.** IDBI Bank has launched 'NRI-Insta-Online' account opening process for NRIs residing in Financial Action Task Force (FATF) member countries

**S179. Ans.(d)**

**Sol.** The Reserve Bank of India (RBI) said Exim Bank has provided soft loans of USD 266.60 million to Rawanda for various projects.

**S180. Ans.(c)****S181. Ans.(c)**

**Sol.** The Reserve Bank of India will make available the National Electronic Funds Transfer system on a 24×7 basis from December 2019 as per the Payment System Vision 2021 document. Presently, the transfer of funds via NEFT can only be done during banks' working hours. The facility of electronic transfer of funds is available from 8 am to 7 pm on all working days, except the second and the fourth Saturday of the month.

**S182. Ans.(b)**

**Sol.** Mastercard announced the launch of Identity Check Express, a next-generation, mobile-first authentication solution that aims to redefine the e-commerce journey for Indian consumers. Mastercard Identity Check Express combines the latest technology, including device intelligence and behavioural biometrics, with the latest EMV 3-D Secure and FIDO authentication standards to deliver an uninterrupted mobile payment experience.

**S183. Ans.(a)**

**Sol.** Mukesh Kumar Jain has been appointed as Managing Director & Chief Executive Officer, Oriental Bank of Commerce and assumed charge on 15th July 2017.

**S184. Ans.(b)**

**Sol.** United Bank of India is an Indian government-owned bank headquartered in Kolkata.

**S185. Ans.(b)**

**Sol.** PS Jayakumar is the present Managing Director & CEO of Bank of Baroda.

**S186. Ans.(b)**

**Sol.** Akshaya Patra, a non-profit organization running one of the world's largest school meals project in India, has been awarded the BBC World Service Global Champion Award for the programme.

**S187. Ans.(a)**

**Sol.** Business-to-business payments startup EnKash has launched the country's first corporate credit card called 'Freedom Card' for small and medium enterprises (SMEs).

**S188. Ans.(a)****S189. Ans.(e)**

**Sol.** National Payments Corporation of India has announced that Aadhaar enabled Payment System has crossed the milestone of over 200 million transactions during July 2019. The transaction count of AePS stood at 220 million in July 2019.

**S190. Ans.(b)**

**Sol.** Project director Vanitha Muthayya, an electronics and communications engineer, and mission director Ritu Karidhal, an aerospace engineer, bring a combined 55 years of ISRO space exploration to the mission. Muthayya and Karidhal also held key roles in India's first lunar mission, Chandrayaan-1, and the country's Mars Orbiter Mission in 2013

**S191. Ans.(a)****S192. Ans.(b)**

**Sol.** Mirzapur is a city of Uttar Pradesh state, India. It is situated on the Ganges (Ganga) River.



**S193. Ans.(a)**

**Sol.** DBS Banks is a multinational banking and financial services corporation headquartered in Marina Bay, Singapore. The company was known as The Development Bank of Singapore Limited. The bank was set up by the Government of Singapore in July 1968 to take over the industrial financing activities from the Economic Development Board.

**S194. Ans.(a)**

**Sol.** A dance form called "Raut Nacha" is known to be mainly performed by the "Yadava" clan (descendants of Lord Krishna) in Central India. This essentially "Lord Krishna dedicated" dance form has originated from the state of Chhattisgarh. This dance is also said to closely resemble the "Ras Leela" which is considered to be the most popular Lord Krishna dance. Furthermore, this dance is performed usually after Diwali for about a week. In addition, it has been essentially created to celebrate the triumph of "good over evil".

**S195. Ans.(d)**

**Sol.** The Saptak Annual Festival of Music is an annual thirteen-day Indian classical music festival held in Ahmedabad, Gujarat.

**S196. Ans.(c)**

**Sol.** Prathama Bank is the First Regional Rural Bank of India, sponsored by Syndicate Bank established on 2nd October, 1975, with its Head Office at Moradabad in accordance with Regional Rural Bank Ordinance 1975 issued on 26th September, 1975.

**S197. Ans.(e)**

**Sol.** Talcher Super Thermal Power Station or NTPC Talcher Kaniha, located in the Angul district of Odisha, is a 3,000MW coal-fired power plant owned and operated by NTPC. The power station currently ranks as the fourth largest operational thermal power plant in India.

**S198. Ans.(b)**

**Sol.** Manas National Park or Manas Wildlife Sanctuary is a national park, UNESCO Natural World Heritage site, a Project Tiger reserve, an elephant reserve and a biosphere reserve in Assam. The name of the park is originated from the Manas River, which is named after the serpent goddess Manasa.

**S199. Ans.(a)****S200. Ans.(d)**

**Sol.** Minister of state for Culture (I/C), Dr Mahesh Sharma, released 3 books: 'Jewellery', 'Ghats of Banaras' and 'Untold Story of Broadcasting', at IGNCA (Indira Gandhi National Centre for the Arts), in New Delhi.

The Authors of the books are as follows:

1. 'Jewellery' was written by Dr Gulab Kothari.
2. 'Ghats of Banaras' was written by Dr Sachidanand Joshi and
3. 'Untold Story of Broadcasting' was written by Dr Gautam Chatterjee.