

Quiz Date: 6th April 2020

Directions (1-5): **Study the following information carefully and answer the questions given below.**

Eight persons are sitting around a square table such that four persons sit at four corners and likes different games and four of them sits at the middle of the side of table and likes different subjects. Some of them are facing towards the center while some are facing outside the center.

P does not like Math. The one who like Hindi sits third to the right of P, who faces outside. R sits third to the left of S. The one who likes English sits third to the right of R. W does not like English. The one who likes Cricket sits third to the right of Q. The one who likes tennis is not immediate neighbor of the person who likes Hindi. T likes hockey and sits on the immediate right of the one who likes English. W sits third to the right of the one who likes Tennis. The one who likes Science sits second to the right of W. The one who likes Science faces Q. The one who likes tennis sits opposite to the one who likes Hockey. R does not like Tennis. The one who likes football sits third to the right of V. V and T face opposite direction. U face same direction as P.

Q1. Which of the following likes by P?

- (a) English
- (b) Tennis
- (c) Hockey
- (d) Football
- (e) None of these

Q2. Who among the following sits second to the right of Q?

- (a) V
- (b) the one who likes cricket
- (c) S
- (d) the one who likes Hindi
- (e) None of these

Q3. Who among the following faces V?

- (a) U
- (b) S
- (c) Q
- (d) W
- (e) None of these

Q4. Which of the following not true about T?

- (a) T sits at corner
- (b) the one who likes tennis sits opposite to T
- (c) the one who likes cricket sits second to the right of T
- (d) Only three persons sit between T and P
- (e) All are true

Q5. Who among the following likes football?

- (a) U
- (b) W
- (c) S
- (d) R
- (e) None of these

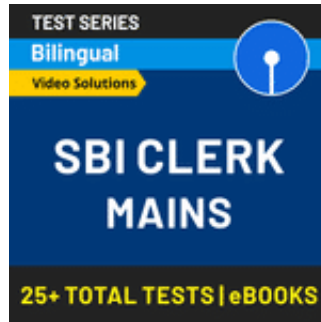

Directions (6-10): **Each of the questions below consists of a question and two statements numbered I and II given below it. You have to decide whether the data provided in the statement are sufficient to answer the question. Read both the statements and Give answer:**

- (a) If the data in statement I alone are sufficient to answer the question, while the data in statement II alone are not sufficient to answer the question.
- (b) If the data in statement II alone are sufficient to answer the question, while the data in statement I alone are not sufficient to answer the question.
- (c) If the data either in statement I alone or in statement II alone are sufficient to answer the question.
- (d) If the data even in both statements I and II together are not sufficient to answer the question.
- (e) If the data in both statement I and II together are necessary to answer the question.

Q6. Who sits third to the left of P, if all persons- M, N, O, P, Q, R, S are sitting in a row are facing south?

I. N sits exactly in the middle of the row. Two people sits between N and S.

II. R sits to the immediate left of N. Only one person sits between R and O. Q sits third to the left of O. M sits fourth to the left of O.

Q7. By using which statement, we can conclude 'Some white is not tiger'.

I. All white is dog. Some white is rabbit. Some cat is dog. No cat is tiger.

II. Some dog is white. Some white is rabbit. All rabbit is cat. No cat is tiger.

Q8. Who among R, S, K, P and M is exactly in the middle when they are arranged in ascending order of their heights?

I. P is taller than S but shorter than M.

II. K is taller than S and M but shorter than R.

Q9. How is 'Life' written in a code language?

I. 'Over your life' is written as 'mn lo kc' and 'your life gift' is written as 'mn lo bd' in that code language.

II. 'market claim lead' is written as 'st jk cd' and 'digital life key' is written as 'lo pq jk' in that code language.

Q10. How is R related to N?

I. P who has only two kids R and N, is the mother-in-law of Q who is sister-in-law of N.

II. S the sister-in-law of R and the daughter-in-law of T who has only two kids R and N.

Directions (11-12): **Study the information carefully and answer the questions given below.**

Point Q is 24m north of point P. Point T 20m south of point S. Point T is 10m west of point U. Point V is 8m north of point R. Point W is 18m south of point U. Point R is 14m east of point Q. Point S is 7m west of V.

Q11. What is the direction of point V with respect to W?

- (a) North
- (b) South-East
- (c) West
- (d) North-West
- (e) None of these

Q12. If point A is midpoint of QR, what is the shortest distance and direction of point A with respect to P?

- (a) 30m, North
- (b) 25m, North-East
- (c) 15m, South-West
- (d) 25m, North-West
- (e) None of these

Directions (13-15): **Study the following information to answer the given questions:**
Given

A*B means B is 2m east to A

A@B means B is 1m west to A

A#B means B is 2m south to A

A%B means B is 1m north to A

A!B means B is 2m east to A

If T#R, Q@P, S*R, Q%S, S%U, holds true, then

Q13. In which direction is T with respect to U?

- (a) South west
- (b) Northeast
- (c) South east
- (d) Northwest
- (e) None of these

Q14. In which direction is P with respect to R?

- (a) South west
- (b) Northeast
- (c) South east
- (d) Northwest
- (e) None of these

Q15. What is the shortest distance U and R?

- (a) 5m
- (b) 3m
- (c) 4m
- (d) $\sqrt{3}$ m
- (e) None of these



Solutions

Solution (1-5):
Sol.

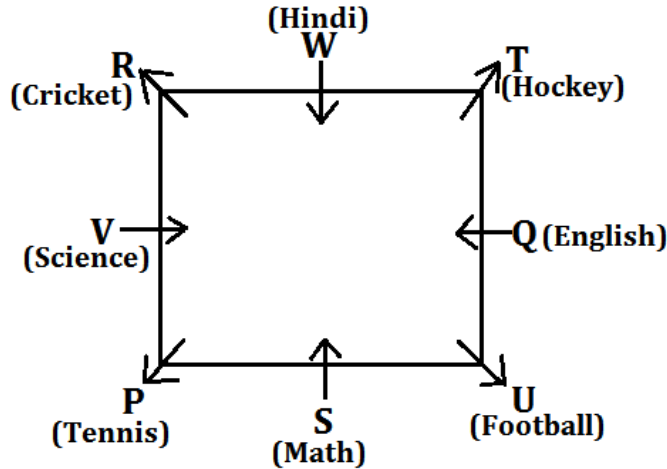

- S1. Ans.(b)
- S2. Ans.(d)
- S3. Ans.(c)
- S4. Ans.(c)
- S5. Ans.(a)

Solution (6-10):

S6. Ans.(e)

Sol. By combining both the statements together we can find that R sits third to the left of P.

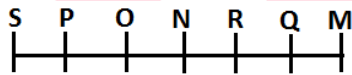

S7. Ans.(b)

Sol. By using only second statement we can conclude that Some white is not tiger.

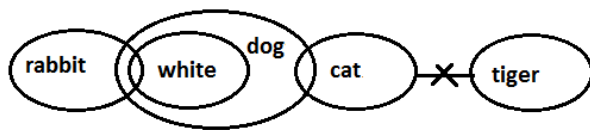

From I: From the above Venn diagram, Can't say as there is no direct relation between white and tiger, thus it cannot be concluded.

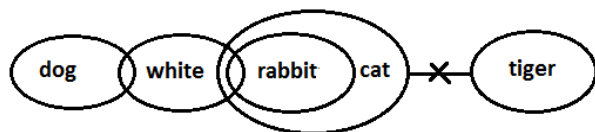

From II: From the above Venn diagram, some white is cat and no cat is tiger, thus the part of white which is cat is also not a part of tiger, thus it can be concluded.

S8. Ans.(e)

Sol. From I, we have: $M > P > S$.

From II, we have: $K > S, K > M, R > K$.

Combining the above two, we have: $R > K > M > P > S$
 Clearly, M is in the middle.

S9. Ans.(e)

Sol. By combining both the statements together we can find that code of 'Life' is 'lo'.

S10. Ans.(a)

Sol. From I we can find R is brother of N.

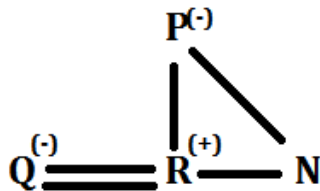

Solutions (11-12):

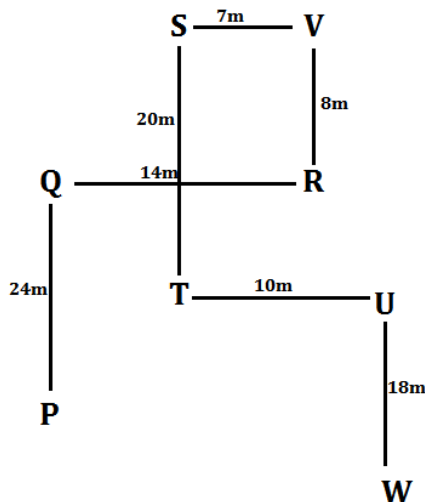

BANKERS

adda247

S11. Ans.(d)

S12. Ans.(b)

Solutions (13-15):

Sol.

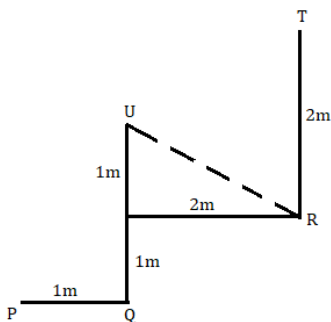

S13. Ans(b)

S14. Ans(a)

S15. Ans(e)



For any Banking/Insurance exam Assistance, Give a Missed call @ 01141183264

