

Quiz Date: 26<sup>th</sup> June 2020

Direction (1-3): Study the following information carefully and answer the questions given below:

A is 10m North of B. C is 12m West of D. E is 5m South of F. B is 8m East of D. F is 10m West of A. G is 5m North of C.

Q1. What is the direction of G with respect to E?

- (a) West
- (b) East
- (c) North-east
- (d) North
- (e) None of these

Q2. What is the shortest distance between D and G?

- (a) 10m
- (b) 11m
- (c) 12m
- (d) 13m
- (e) None of these

Q3. If H is in the exactly between C and D then, H is in which direction with respect to F?

- (a) North
- (b) South
- (c) South-east
- (d) South-west
- (e) None of these

Directions (4-6): Study the following information carefully and answer the questions given below:

Point Q is 20m to the North of Point P. Point Q is 10m to the west of Point R. Point R is 10m to the North of Point S. Point T is 10m to the East of Point S. Point U is 10m to the South of Point T.

Q4. In which direction is Point P with respect to Point U?

- (a) North
- (b) North West
- (c) West
- (d) South East
- (e) None of these

Q5. What is the total distance from the point P to Point T?

- (a) 40m
- (b) 50m
- (c) 60m
- (d) 70m

(e) None of these

Q6. If Point X is 10m to the South of Point S then in which direction is point U with respect to Point X?

- (a) North
- (b) West
- (c) East
- (d) South East
- (e) None of these

Directions (7-9): Study the following information carefully and answer the questions given below:

Point S is 10m in East direction from point O. Point Q is 10m in North direction from point O. Point U is 10m in South direction from point O. Point P is 10m in West direction from point O. Point R is 10m in North-East direction from point O. Point T is 10m in South-East direction from point O.

Q7. In which direction is point R with respect to Point P?

- (a) North East
- (b) North
- (c) South
- (d) East
- (e) None of these

**BANKERS**

Q8. What is the shortest distance between point U and Point S?

- (a) 10
- (b)  $20\sqrt{2}$
- (c)  $10\sqrt{2}$
- (d) 20
- (e) None of these

**adda247**

Q9. In which direction is point Q with respect to point T?

- (a) North East
- (b) North
- (c) East
- (d) North West
- (e) None of these

Direction (10-12): Study the following information carefully and answer the questions given below:

Point A is 10m west of Point B. Point C is 10m to the north of Point B. Point D is 5m to the east of Point C. Point E is 5m to the north of Point D. Point F is 15m to the west of Point E. Point G is 5m to the south of Point F. Point H is 5m to west of Point G.

Q10. In which direction is E with respect to A?

- (a) West

- (b) East
- (c) North-east
- (d) North
- (e) None of these

Q11. What is the shortest distance between C and E?

- (a) 10m
- (b) 5m
- (c) 11m
- (d)  $5\sqrt{2}$ m
- (e) None of these

Q12. If Point Z is exactly in between E and F then, D is in which direction with respect to Z?

- (a) North
- (b) South
- (c) South-east
- (d) South-west
- (e) None of these

Directions (13-15): Study the following information carefully and answer the questions given below:

Three persons i.e. P, Q and R starts their journey from point O. P walks 10m in the East direction then turns to his left and walks for 10m. Q walks 10m in the West direction then turns to his left and walks for 10m. R walks 10m in the South direction then turns to his left and walks for 10m.

Q13. R is in which direction with respect to P now?

- (a) North East
- (b) North
- (c) South
- (d) East
- (e) None of these

Q14. What is the shortest distance between Q and P?

- (a) 10m
- (b)  $20\sqrt{2}$  m
- (c)  $10\sqrt{2}$ m
- (d) 20m
- (e) None of these

Q15. In which direction is Q with respect to R?

- (a) North East
- (b) North
- (c) West
- (d) North West

(e) None of these

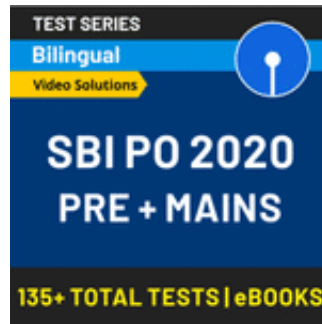

Solutions

Solutions (1-3):

S1. Ans. (a)

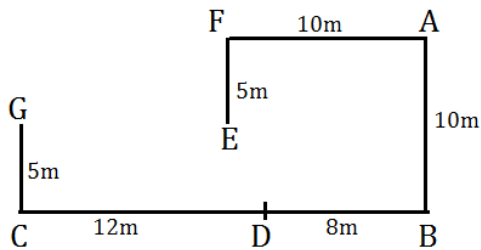

Sol.

S2. Ans. (d)

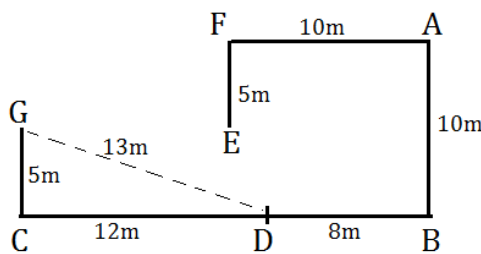

Sol.

S3. Ans. (d)

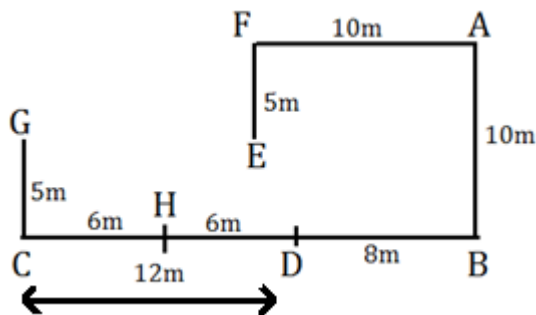

Sol.

Solutions (4-6):

S4. Ans. (c)

Sol.

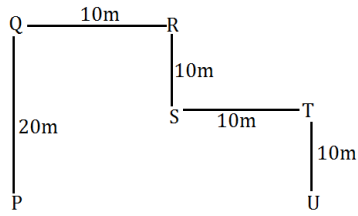

S5. Ans. (b)

Sol.

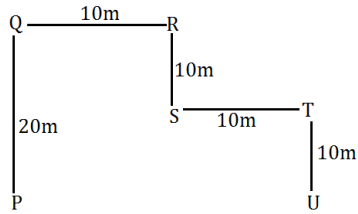

S6. Ans. (c)

Sol.

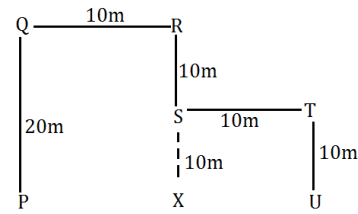

Solutions (7-9):

S7. Ans. (a)

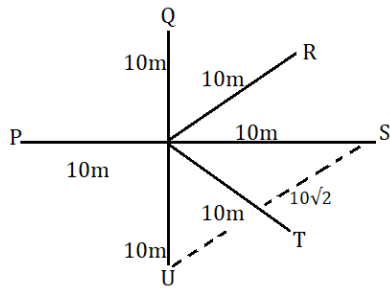

Sol.

S8. Ans. (c)

Sol.



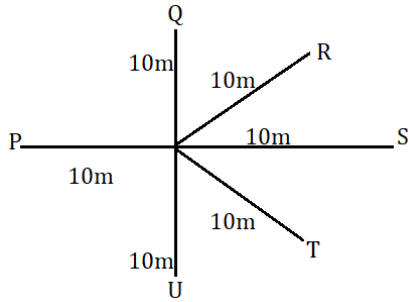

S9. Ans. (d)

Sol.

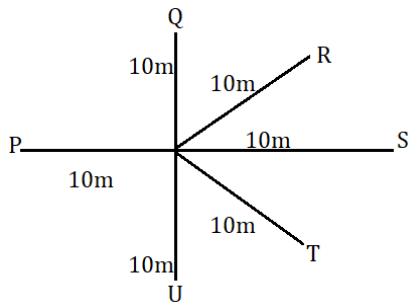

Solutions (10-12)

S10. Ans. (c)

Sol.

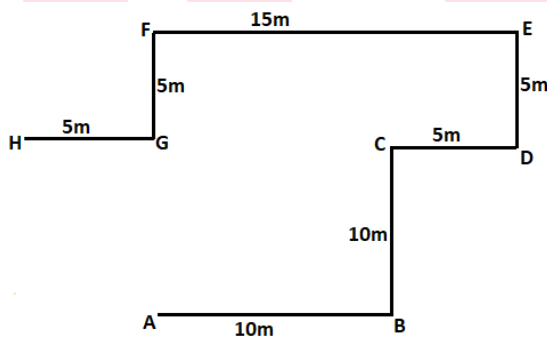

**BANKERS**

dda247

S11. Ans. (d)

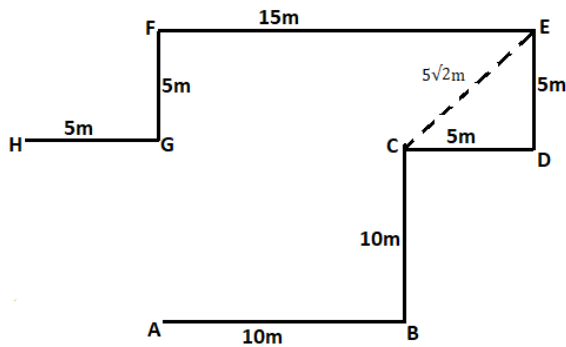

Sol:

S12. Ans. (c)

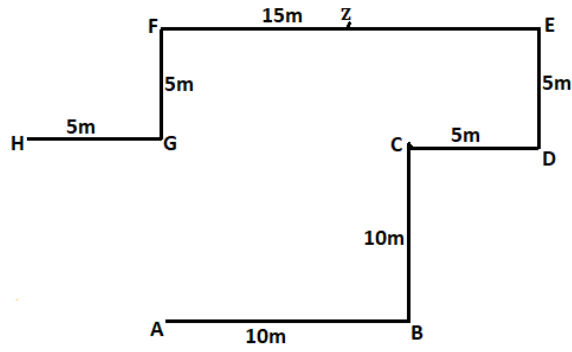

Sol:

Solution (13-15):

S13. Ans. (c)

Sol.

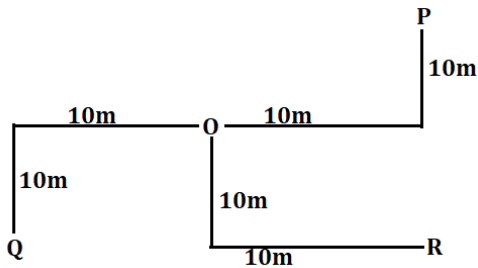

**BANKERS**

S14. Ans. (b)

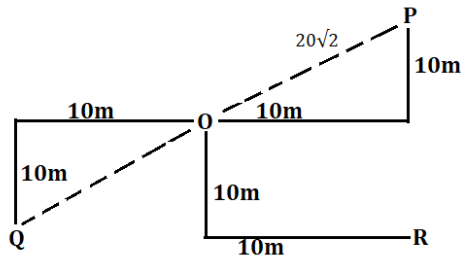

adda247

Sol.

S15. Ans. (c)

Sol.

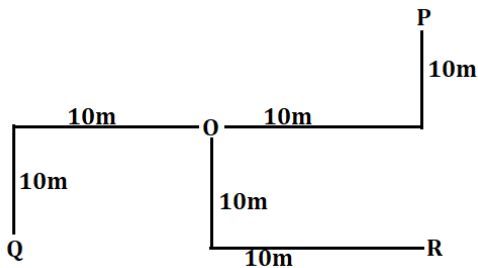



For any Banking/Insurance exam Assistance, Give a Missed call @ 01141183264

