

# Most Important 200Q Reasoning PDF 2 for RRB PO & Clerk (Solutions)

Solutions (1-5):

S1. Ans.(c)

S2. Ans.(c)

S3. Ans.(a)

S4. Ans.(c)

S5. Ans.(e)

Solutions (6-10):

S6. Ans.(a)

Sol.

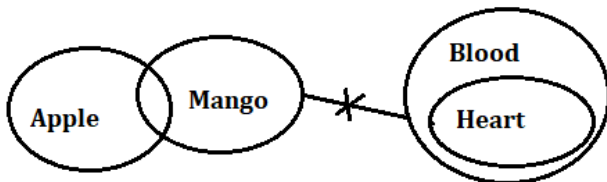

S7. Ans.(a)

Sol.

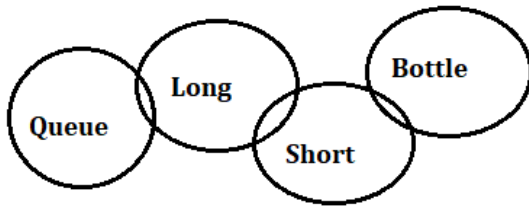

S8. Ans.(c)

Sol.

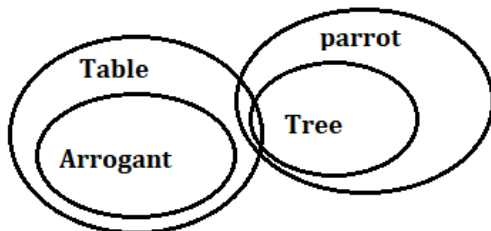

S9. Ans.(b)

Sol.

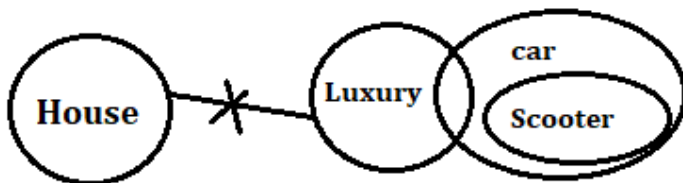

TEST SERIES  
BILINGUAL  
Video Solutions

IBPS RRB 2021  
CLERK PRELIMS

35 TOTAL TESTS

**S10. Ans.(e)**

**Sol.**

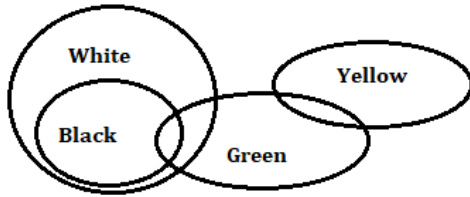

**Solutions (11-15):**

**S11. Ans.(a)**

**Sol. I.**  $E > A$  (True)    **II.**  $E \geq B$  (false)

**S12. Ans.(b)**

**Sol. I.**  $Q = K$  (false)    **II.**  $Q > K$  (True)

**S13. Ans.(d)**

**Sol. I.**  $Q > B$  (false)    **II.**  $B > Q$  (false)

**S14. Ans.(e)**

**Sol. I.**  $L > Q$  (True)    **II.**  $X < L$  (True)

**S15. Ans.(c)**

**Sol. I.**  $M > J$  (false)    **II.**  $J = M$  (false)



**Solutions (16-20):**

Word	Code
Energy	nc
Save	su
Bright	ki
Light	da
Human	ra
South	ph
Found	mo
Effect	ti
health	gi
system	zo

**S16. Ans.(b)**

**S17. Ans.(d)**

S18. Ans.(c)

S19. Ans.(c)

S20. Ans.(c)

Solutions (21-25):

Floor	Person
8	S
7	T
6	Vacant
5	R
4	P
3	V
2	Q
1	U

S21. Ans.(b)

S22. Ans.(c)

S23. Ans.(c)

S24. Ans.(a)

S25. Ans.(d)

Solutions (26-30):

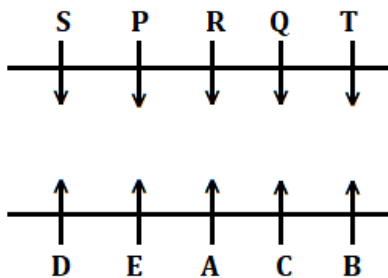

S26. Ans.(e)

S27. Ans.(a)

S28. Ans.(d)



**S29. Ans.(b)**

**S30. Ans.(c)**

**Solutions (31-35):**

Day	Player	Sport
Monday	S	Volleyball
Tuesday	Z	Football
Wednesday	Y	Volleyball
Thursday	X	Basketball
Friday	R	Football
Saturday	Q	Basketball
Sunday	P	Football

**S31. Ans.(b)**

**S32. Ans.(d)**

**S33. Ans.(b)**

**S34. Ans.(d)**

**S35. Ans.(c)**

**Solutions (36-37):**

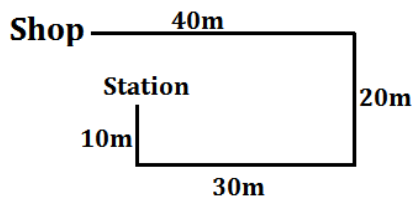

**S36. Ans.(b)**

**S37. Ans.(e)**

**S38. Ans.(d)**

**Sol.**

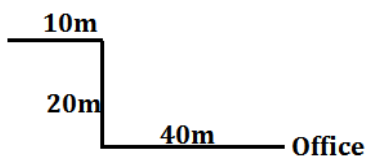

**Solutions (39-40):**

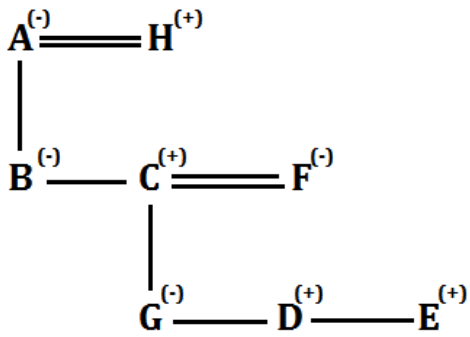

**S39. Ans.(a)**

**S40. Ans.(d)**

**Solutions (41-45):**

**S41. Ans.(d)**

**Sol.** ! K %, ^ X \$ and \$ W &

**S42. Ans.(d)**

**S43. Ans.(a)**

**S44. Ans.(d)**

**S45. Ans.(a)**

**Solutions (46-50):**

Persons	Years
A	1992
B	2003
C	1980
D	1987
E	2012
F	1998

**S46. Ans.(c)**

**S47. Ans.(b)**

**S48. Ans.(d)**



TEST SERIES  
BILINGUAL  
Video Solutions

**IBPS RRB 2021  
PO & CLERK  
PRELIMS**

70+ TOTAL TESTS

S49. Ans.(c)

S50. Ans.(c)

Solutions (51-53):

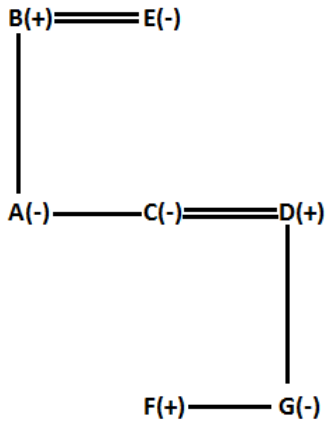

S51. Ans.(d)

S52. Ans.(b)

S53. Ans.(b)

S54. Ans.(c)

S55. Ans.(e)

Sol. True



Solutions (56-58):

S56. Ans.(b)

Sol.

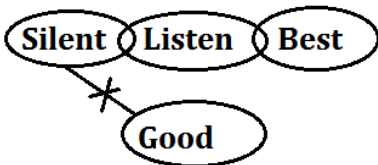

S57. Ans.(e)

Sol.

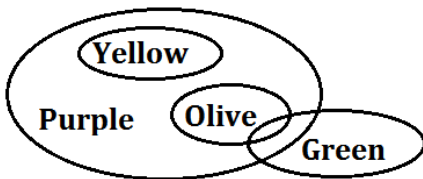

S58. Ans.(c)

Sol.



Solution (59-60):

$P > R > S > Q(60\text{kg}) > T/U > T/U$

S59. Ans.(b)

S60. Ans.(d)

Solutions (61-65):

S61. Ans.(b)

Sol. 7 S A

S62. Ans.(d)

Sol. @ Q, !E, \$ I, \*T, &V, %O,

S63. Ans.(c)

S64. Ans.(a)

S65. Ans.(a)

Solutions (66-68):

S66. Ans.(b)

Sol. I:  $O > X$ (False)

II:  $W > L$  (True)

S67. Ans.(a)

Sol. I:  $E > M$ (True)

II:  $O < Z$ (False)

S68. Ans.(d)

Sol. I:  $L \leq X$ (False)

II:  $X > L$ (False)

Solution (69-71):

S69. Ans.(e)

Sol.

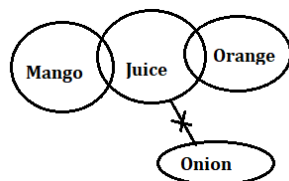

**S70. Ans.(c)**

**Sol.**

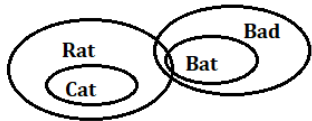

**S71. Ans.(d)**

**Sol.**

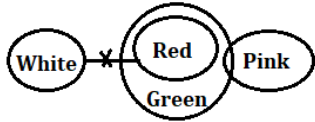

**Solutions (72-76):**

Word	Code
Economic	le
Budget	me
Scheme	ue
Government	ae
Yojana	te
Aviation	ge
Export	de
Agriculture	ce
National/Ministry	ye/we



**S72. Ans.(d)**

**S73. Ans.(b)**

**S74. Ans.(a)**

**S75. Ans.(c)**

**S76. Ans.(c)**

**S77. Ans.(b)**

**Sol.**

**HIGHLIGHT**



**Solutions (78-80):**

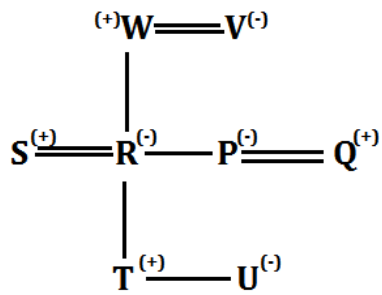

S78. Ans.(b)

S79. Ans.(b)

S80. Ans.(c)

S81. Ans.(d)

S82. Ans.(c)

**Solutions (83-85):**

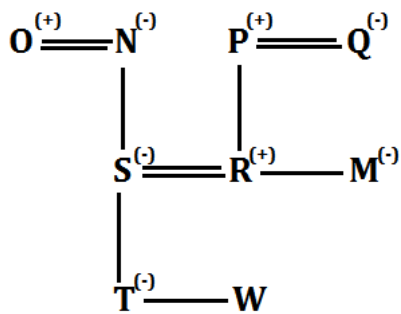

S83. Ans.(b)

S84. Ans.(d)

S85. Ans.(e)

**Solutions (86-90):**

Word	Code
During	hg
Prepare	kp
Register	ok
Upon	ks
Taken	ir
Country	fu
Doubt	tg
Farm	gb
Find/Details	xz/lo



S86. Ans.(e)

S87. Ans.(e)

S88. Ans.(b)

S89. Ans.(c)

S90. Ans.(a)

**Solution (91-95):**

S91. Ans.(a)

I:  $Z < X$ (True)

II:  $W > D$ (False)

S92. Ans.(d)

I:  $R < F$ (False)

II:  $E > C$ (False)

S93. Ans.(c)

I:  $D = N$ (False)

II:  $N < D$ (False)

S94. Ans.(b)

I:  $M < C$ (False)

II:  $K < Q$ (True)

S95. Ans.(e)

I:  $W < T$ (True)

II:  $H > O$ (True)

**Solution (96-97):**

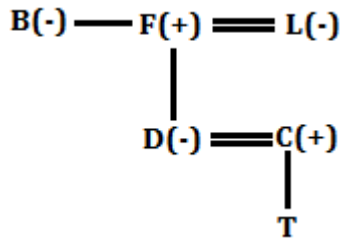

S96. Ans.(d)

S97. Ans.(e)

**Solution (98-100):**

S98. Ans.(c)

Sol.

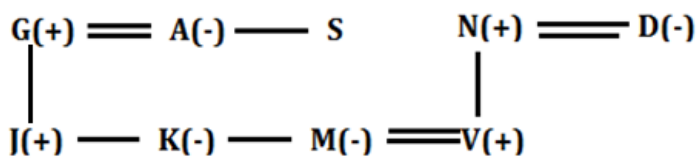

S99. Ans.(b)

Sol.

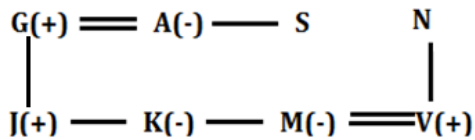

S100. Ans.(c)

Sol.

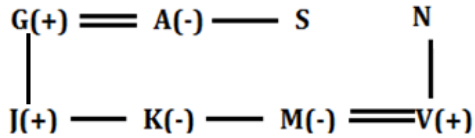

**Solutions (101-105):**

Word	Code
Temple	mn
Pretend	ie
Station	as
Vote	bn
Time	cd
Trust	zq
Case	st
Friend/run	zx/yx



S101. Ans.(a)

S102. Ans.(d)

S103. Ans.(e)

S104. Ans.(b)

S105. Ans.(d)

**Solutions (106-108):**

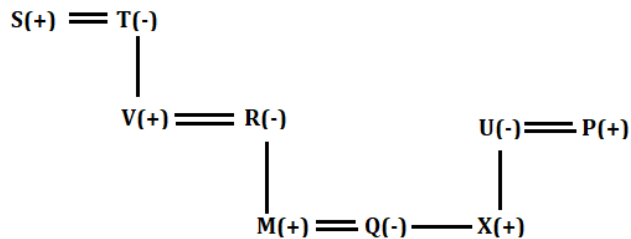

S106. Ans.(a)

S107. Ans.(c)

S108. Ans.(c)

S109. Ans.(d)

TEST SERIES  
BILINGUAL  
Video Solutions

IBPS RRB 2021  
CLERK PRELIMS

35 TOTAL TESTS

S110. Ans.(e)

Sol.

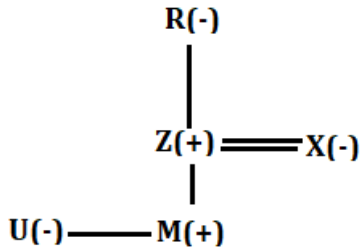

Solutions (111-115):

S111. Ans.(c)

S112. Ans.(c)

S113. Ans.(d)

S114. Ans.(b)

S115. Ans.(a)

Solutions (116-118):

S116. Ans.(c)

Sol.

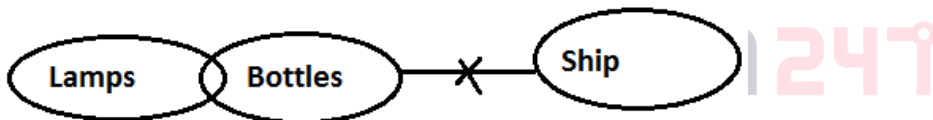

S117. Ans.(b)

Sol.

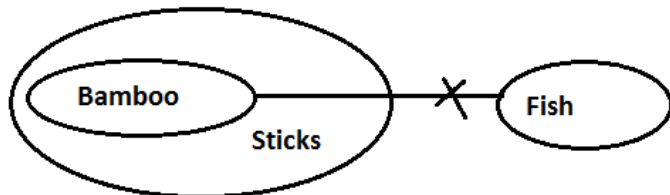

S118. Ans.(c)

Sol.

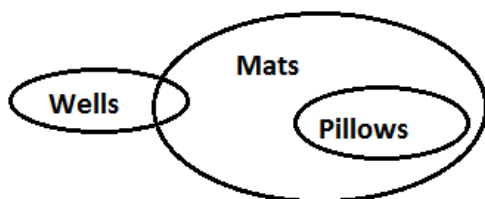

**Solutions (119-123):**

**S119. Ans.(a)**

**Sol.**

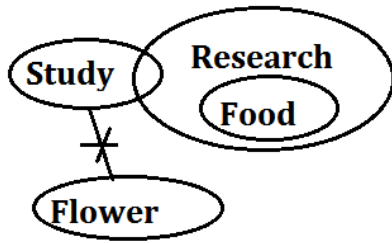

**S120. Ans.(e)**

**Sol.**

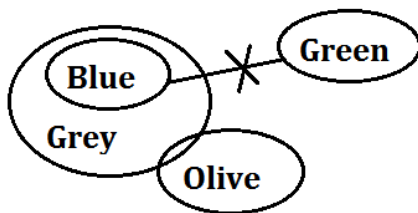

**S121. Ans.(b)**

**Sol.**

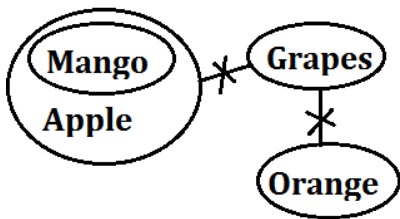

**S122. Ans.(d)**

**Sol.**

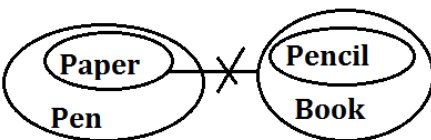

**S123. Ans.(c)**

**Sol.**

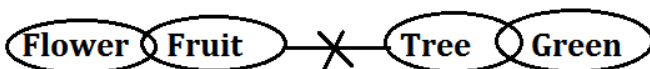

S124. Ans.(c)

Sol.

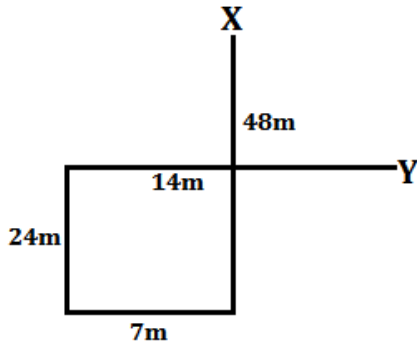

S125. Ans.(d)

S126. Ans.(a)

Solutions (127-131):

Floor	Person	Banks
7	Q	PNB
6	U	HDFC
5	B	SBI
4	T	BOM
3	P	BOI
2	D	ICICI
1	X	RBL



S127. Ans.(c)

S128. Ans.(b)

S129. Ans.(c)

S130. Ans.(a)

S131. Ans.(d)

Solutions (132-134):

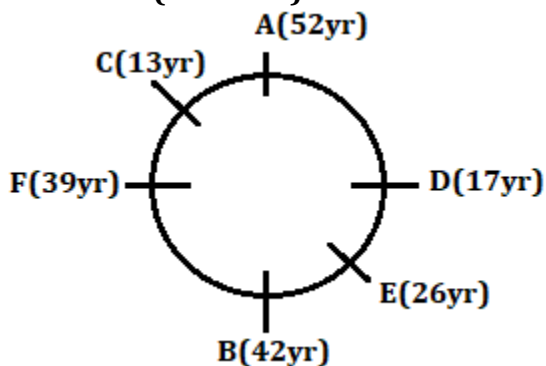

S132. Ans.(c)

S133. Ans.(d)

S134. Ans.(b)

**S135. Ans.(d)**

**Sol.** Original number- 9365714873

Obtained number- 4468826135

**S136. Ans.(d)**

**Sol.**

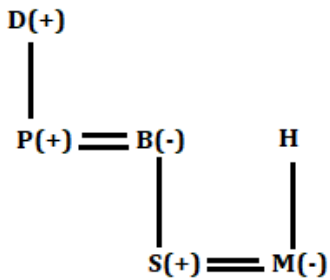

**Solutions (137-141):**

Day	Person	Place
Monday	D	Kerala
Tuesday	B	Ladakh
Wednesday	G	Nainital
Thursday	C	Varanasi
Friday	A	Agra
Saturday	F	Jaisalmer
Sunday	E	Hampi

**S137. Ans.(b)**

**S138. Ans.(b)**

**S139. Ans.(b)**

**S140. Ans.(d)**

**S141. Ans.(c)**



**Solutions (142-143):**

**S142. Ans.(e)**

**S143. Ans.(b)**

**Solutions (144-146):**

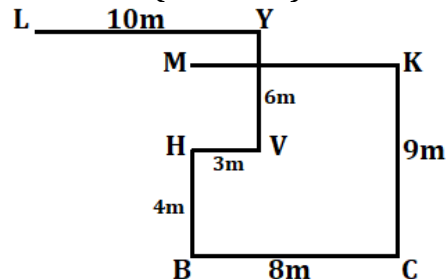

**S144. Ans.(c)**

**S145. Ans.(b)**

**S146. Ans.(c)**

**Solutions (147-151):**

S147. Ans.(c)

S148. Ans.(d)

S149. Ans.(a)

S150. Ans.(a)

S151. Ans.(b)

**Solution (152-156):**

Boxes	Colour
A	White
E	Blue
H	Green
D	Blue
F	White
B	Green
G	Brown
C	Green

S152. Ans.(d)

S153. Ans.(b)

S154. Ans.(c)

S155. Ans.(d)

S156. Ans.(e)

**Solution (157-161):**

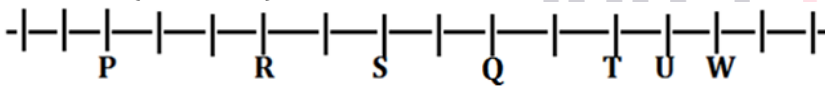

S157. Ans.(b)

S158. Ans.(d)

S159. Ans.(d)

S160. Ans.(e)

S161. Ans.(b)

**Solutions (162-166):**

Person	Food item	Class
M	Banana	Singing
N	Orange	Acting
O	Candy	Crafting
W	Oats	Acting
X	Rice	Singing
Y	Chocolate	Crafting
Z	Milk	Acting

TEST SERIES  
BILINGUAL  
Video Solutions



**IBPS RRB 2021  
PO & CLERK  
PRELIMS**

**70+ TOTAL TESTS**



**S162. Ans.(b)**

**S163. Ans.(c)**

**S164. Ans.(a)**

**S165. Ans.(e)**

**S166. Ans.(c)**

**Solution (167-171):**

Floor	Person
8	P
7	R
6	S
5	T
4	V
3	Q
2	W
1	U

**S167. Ans.(d)**

**S168. Ans.(d)**

**S169. Ans.(a)**

**S170. Ans.(d)**

**S171. Ans.(c)**

**Solution (172-176):**

**S172. Ans.(d)**

**S173. Ans.(a)**

**S174. Ans.(e)**

**S175. Ans.(b)**

**S176. Ans.(d)**



**S177. Ans.(b)**

**Sol.** Position of Shubham from right end=  $45-(15-1)= 31$

Position of Akash from right end= 21

So, no. of boys between them= 9

**S178. Ans.(d)**

**Sol.** Total number of students in row =  $12+20-1= 31$

Position of Ananya from left end=  $31-(14-1)= 18$

**Solutions (179-181):**

$B > D > A > F > C(56) > E$

**S179. Ans.(c)**

**S180. Ans.(b)**

**S181. Ans.(d)**

**S182. Ans.(e)**

**Solution (183-185):**

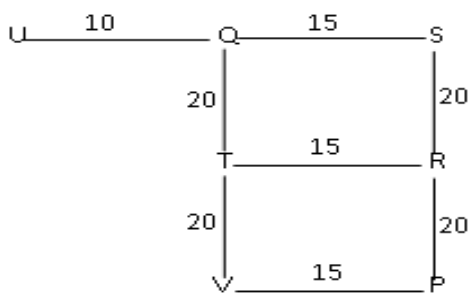

**S183. Ans.(d)**

**S184. Ans.(a)**

**S185. Ans.(c)**

**Solution (186-190):**

Floor	Persons
8	D
7	H
6	A
5	C
4	E
3	B
2	F
1	G

**S186. Ans.(d)**

S187. Ans.(e)

S188. Ans.(c)

S189. Ans.(d)

S190. Ans.(a)

Solution (191-195):

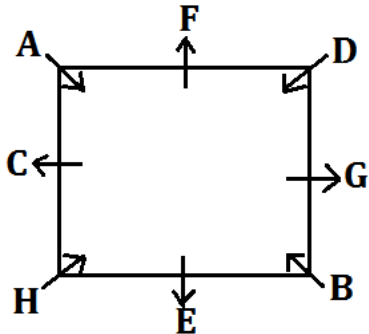

S191. Ans.(d)

S192. Ans.(b)

S193. Ans.(d)

S194. Ans.(a)

S195. Ans.(c)

Solution (196-197):

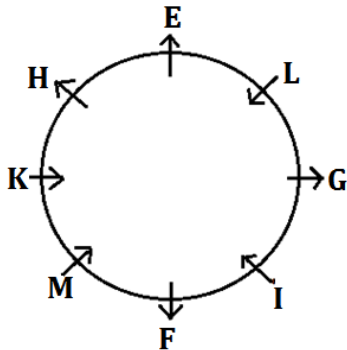

S196. Ans.(c)

S197. Ans.(d)

S198. Ans.(a)

S199. Ans.(d)

S200. Ans.(d)



**BILINGUAL**

**IBPS RRB  
PO & CLERK  
PRELIMS CRASH COURSE**

Starts July 16, 2021 **1:30 PM to 4:30 PM**

# BOOKS



Visit: [publications.adda247.com](http://publications.adda247.com) & [store.adda247.com](http://store.adda247.com)  
 For any information, mail us at [publications@adda247.com](mailto:publications@adda247.com)