

All India Maha Mock of SBI PO Mains 2021- 28th December- 2021 (Solutions)

S1. Ans.(c)

Sol. From the given statements, the area of the square garden is $1600m^2$.

As we know, area of the square garden (a^2) = $1600m^2$, then $a = 40m$ and each of the side of the table is 40m. D is an immediate neighbor of both G and C and sits at the corner of the table. Distance between D and G is divisible by 10. The distance between D and G is 10m more than the distance between C and D and not more than or equal to the sides of the table. C does not sit immediate right of D. From these conditions we get 2 possibilities i.e. Case 1 and Case 2.

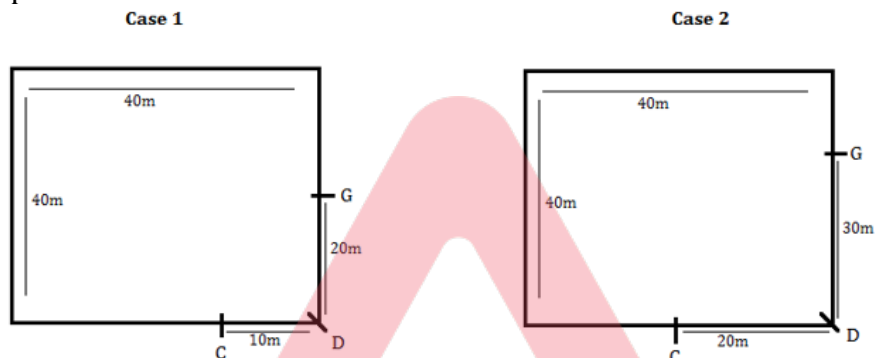

B likes Apple and sits at a distance of 10m to the right of G. E likes Guava and sits opposite to B. P likes Papaya sits 20m to the left of E.

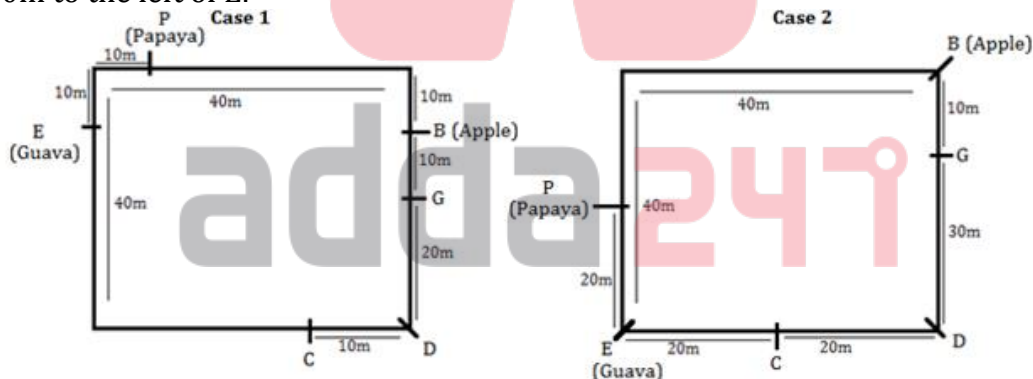

The minimum distance between E and P is same as the minimum distance between E and C. Here Case 1 is ruled out now. A likes Mango and sits 12m distance from P. Here we get one more possibility i.e. Case 2a. Three of them are sitting at the corners while rests of them are sitting on the sides of the garden. H likes Lychee and sits opposite to the midpoint of E and C.

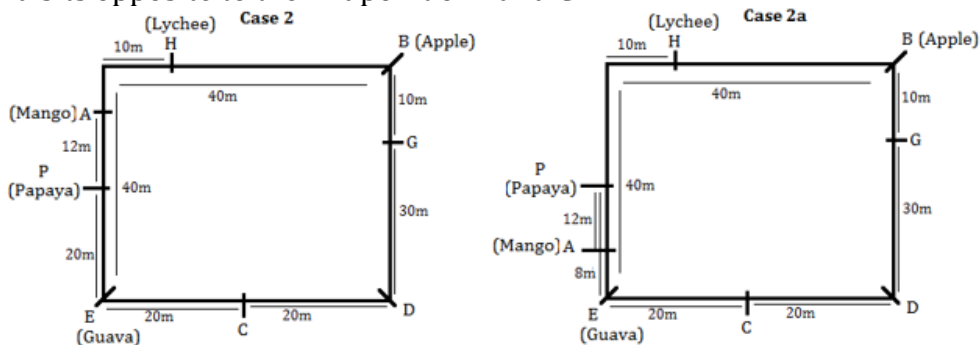

H is the neighbor of both A and F. From this condition Case 2a is ruled out now. F sits at a distance of 28m from the one who likes Grapes. According to the given statements F sits only in between H and B then only G likes Grapes. The one who likes Banana sits immediate left of the one who likes Apricot. So, the final arrangement is-

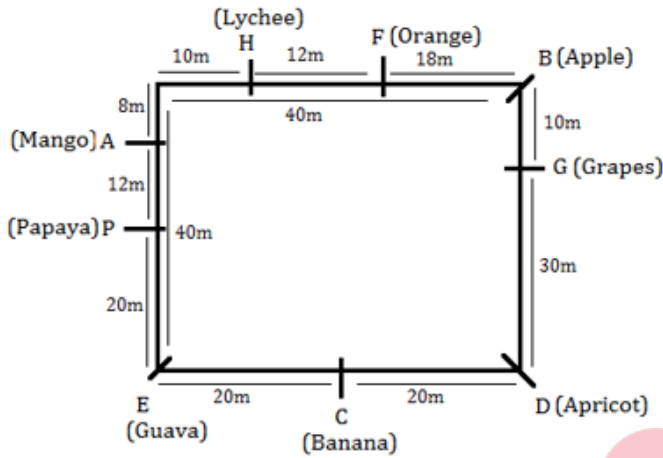

S2. Ans.(e)

Sol. From the given statements, the area of the square garden is 1600m².

As we know, area of the square garden (a^2) = 1600m², then $a = 40m$ and each of the side of the table is 40m. D is an immediate neighbor of both G and C and sits at the corner of the table. Distance between D and G is divisible by 10. The distance between D and G is 10m more than the distance between C and D and not more than or equal to the sides of the table. C does not sit immediate right of D. From these conditions we get 2 possibilities i.e. Case 1 and Case 2.

Case 1

Case 2

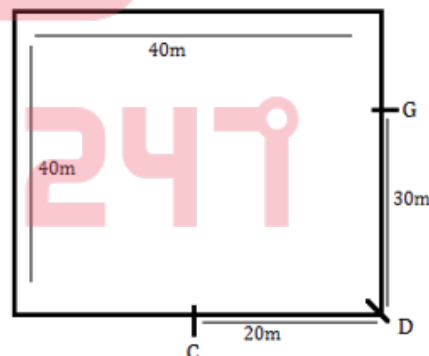
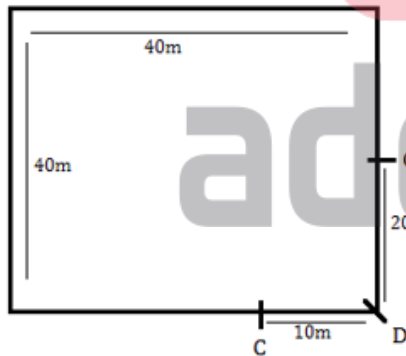

B likes Apple and sits at a distance of 10m to the right of G. E likes Guava and sits opposite to B. P likes Papaya sits 20m to the left of E.

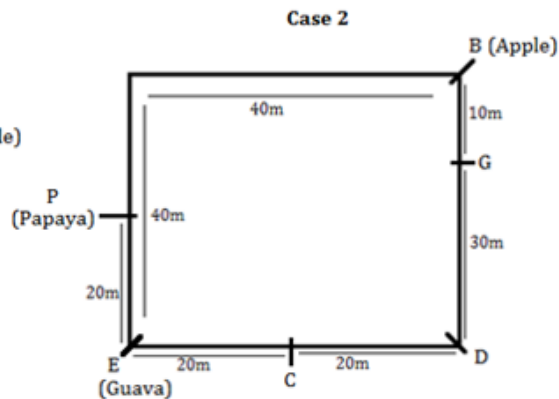
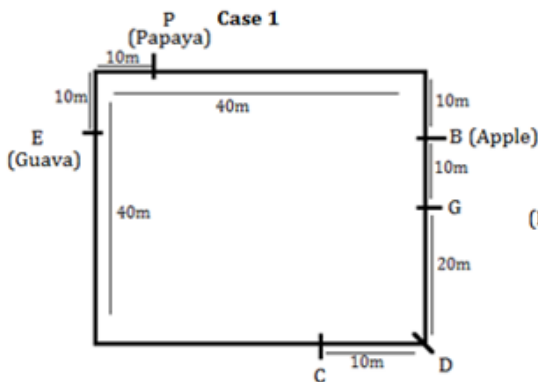

The minimum distance between E and P is same as the minimum distance between E and C. Here Case 1 is ruled out now. A likes Mango and sits 12m distance from P. Here we get one more possibility i.e. Case 2a. Three of them are sitting at the corners while rests of them are sitting on the sides of the garden. H likes Lychee and sits opposite to the midpoint of E and C.

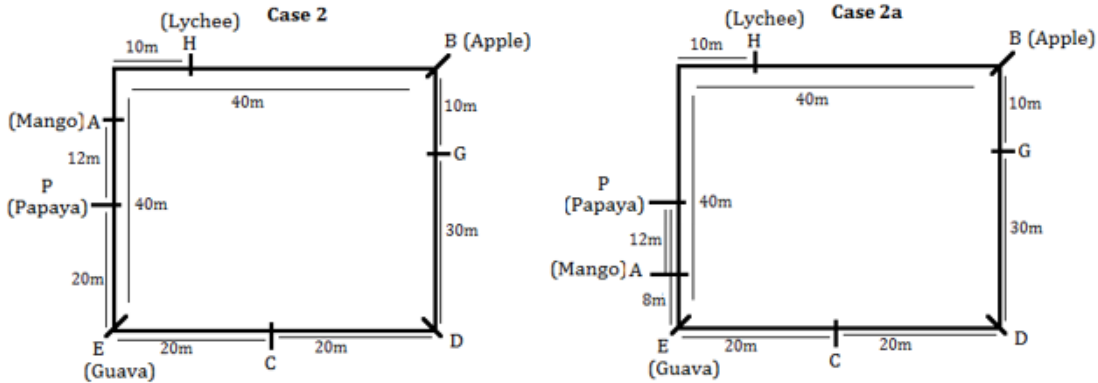

H is the neighbor of both A and F. From this condition Case 2a is ruled out now. F sits at a distance of 28m from the one who likes Grapes. According to the given statements F sits only in between H and B then only G likes Grapes. The one who likes Banana sits immediate left of the one who likes Apricot. So, the final arrangement is-

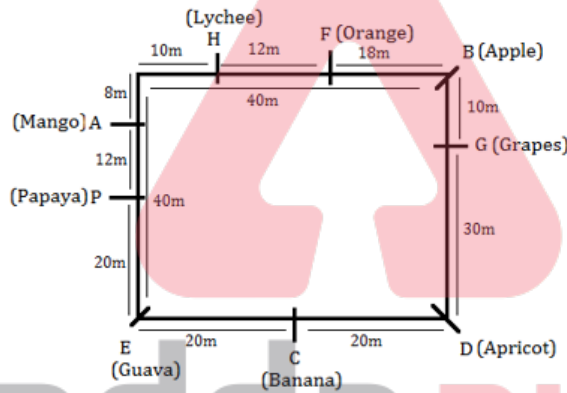

S3. Ans.(a)

Sol. From the given statements, the area of the square garden is $1600m^2$.

As we know, area of the square garden (a^2) = $1600m^2$, then $a = 40m$ and each of the side of the table is 40m. D is an immediate neighbor of both G and C and sits at the corner of the table. Distance between D and G is divisible by 10. The distance between D and G is 10m more than the distance between C and D and not more than or equal to the sides of the table. C does not sit immediate right of D. From these conditions we get 2 possibilities i.e. Case 1 and Case 2.

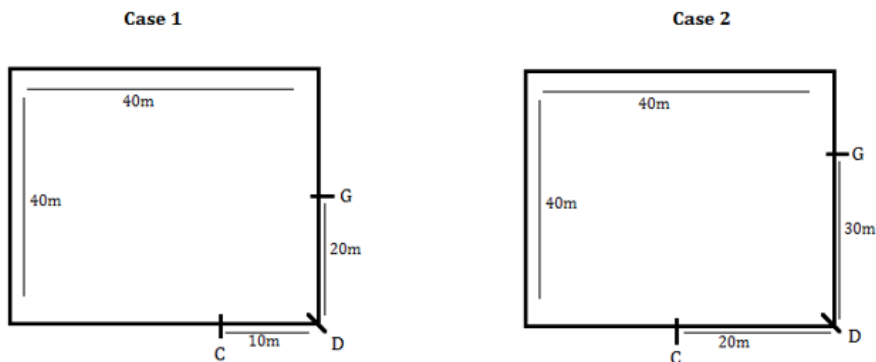

B likes Apple and sits at a distance of 10m to the right of G. E likes Guava and sits opposite to B. P likes Papaya sits 20m to the left of E.

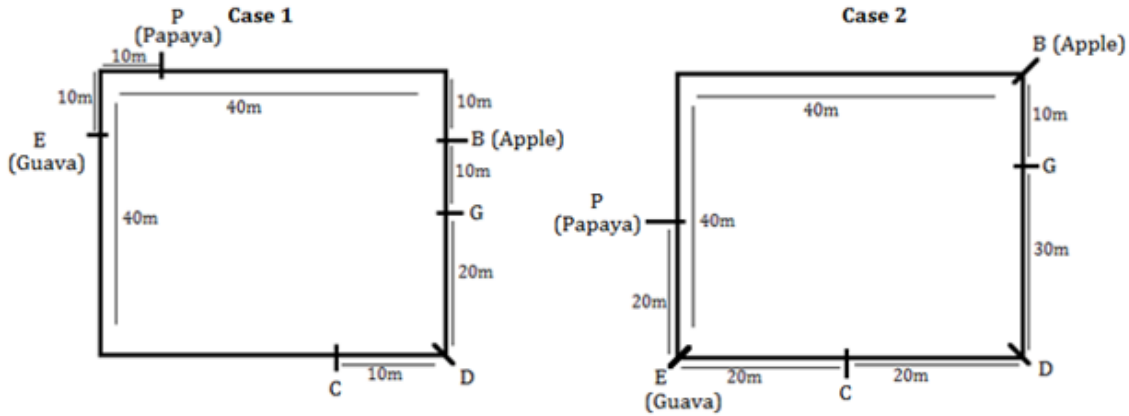

The minimum distance between E and P is same as the minimum distance between E and C. Here Case 1 is ruled out now. A likes Mango and sits 12m distance from P. Here we get one more possibility i.e. Case 2a. Three of them are sitting at the corners while rests of them are sitting on the sides of the garden. H likes Lychee and sits opposite to the midpoint of E and C.

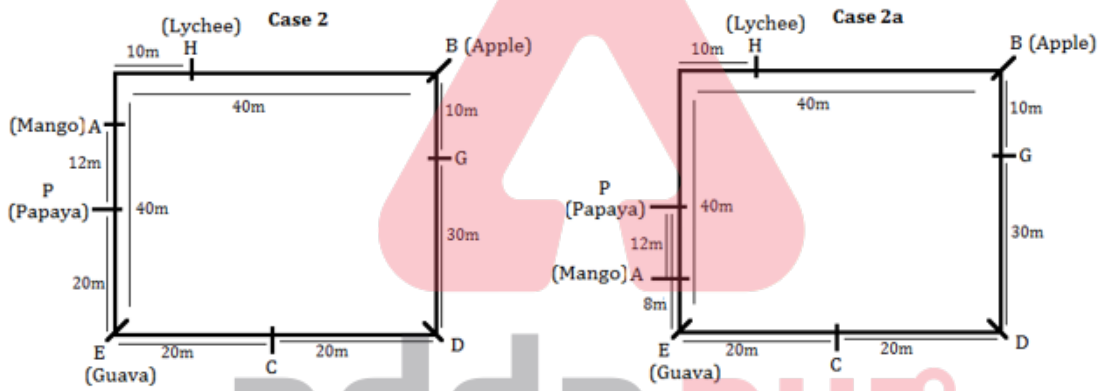

H is the neighbor of both A and F. From this condition Case 2a is ruled out now. F sits at a distance of 28m from the one who likes Grapes. According to the given statements F sits only in between H and B then only G likes Grapes. The one who likes Banana sits immediate left of the one who likes Apricot. So, the final arrangement is-

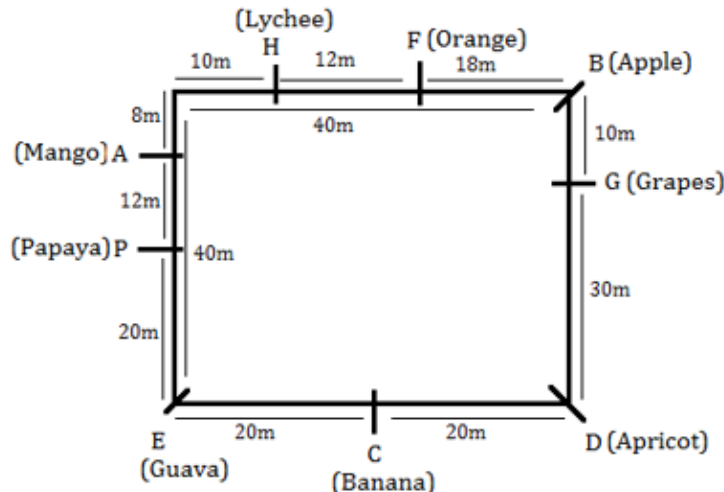

S4. Ans.(d)

Sol. From the given statements, the area of the square garden is $1600m^2$.

As we know, area of the square garden (a^2) = $1600m^2$, then $a = 40m$ and each of the side of the table is 40m. D is an immediate neighbor of both G and C and sits at the corner of the table. Distance between D and G is divisible by 10. The distance between D and G is 10m more than the distance between C and D and not more than or equal to the sides of the table. C does not sit immediate right of D. From these conditions we get 2 possibilities i.e. Case 1 and Case 2.

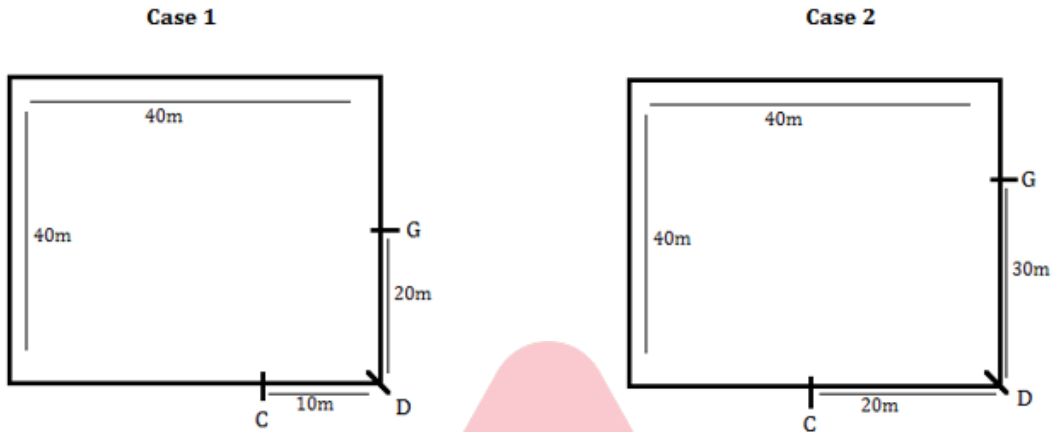

B likes Apple and sits at a distance of 10m to the right of G. E likes Guava and sits opposite to B. P likes Papaya sits 20m to the left of E.

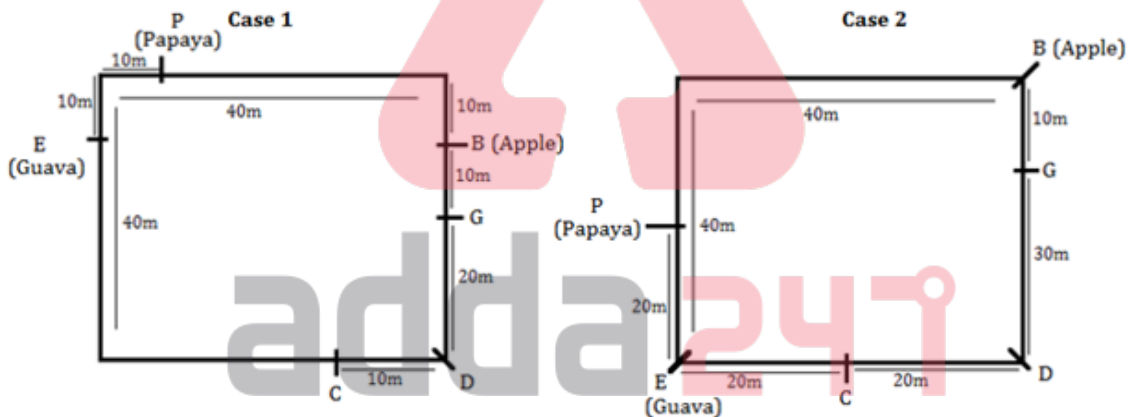

The minimum distance between E and P is same as the minimum distance between E and C. Here Case 1 is ruled out now. A likes Mango and sits 12m distance from P. Here we get one more possibility i.e. Case 2a. Three of them are sitting at the corners while rests of them are sitting on the sides of the garden. H likes Lychee and sits opposite to the midpoint of E and C.

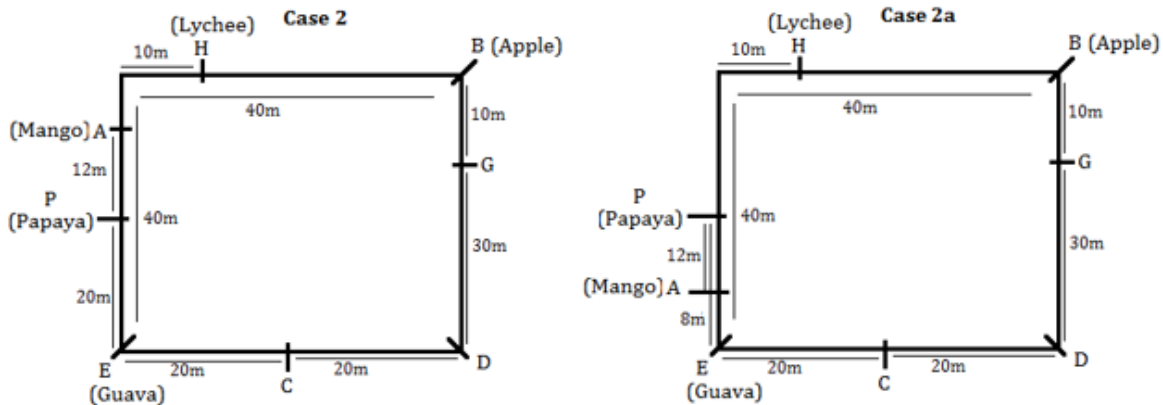

H is the neighbor of both A and F. From this condition Case 2a is ruled out now. F sits at a distance of 28m from the one who likes Grapes. According to the given statements F sits only in between H and B then only G likes Grapes. The one who likes Banana sits immediate left of the one who likes Apricot. So, the final arrangement is-

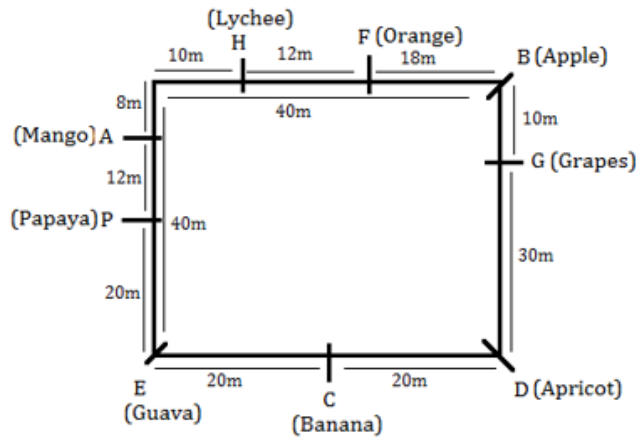

S5. Ans.(d)

Sol. From the given statements, the area of the square garden is $1600m^2$.

As we know, area of the square garden (a^2) = $1600m^2$, then $a = 40m$ and each of the side of the table is 40m. D is an immediate neighbor of both G and C and sits at the corner of the table. Distance between D and G is divisible by 10. The distance between D and G is 10m more than the distance between C and D and not more than or equal to the sides of the table. C does not sit immediate right of D. From these conditions we get 2 possibilities i.e. Case 1 and Case 2.

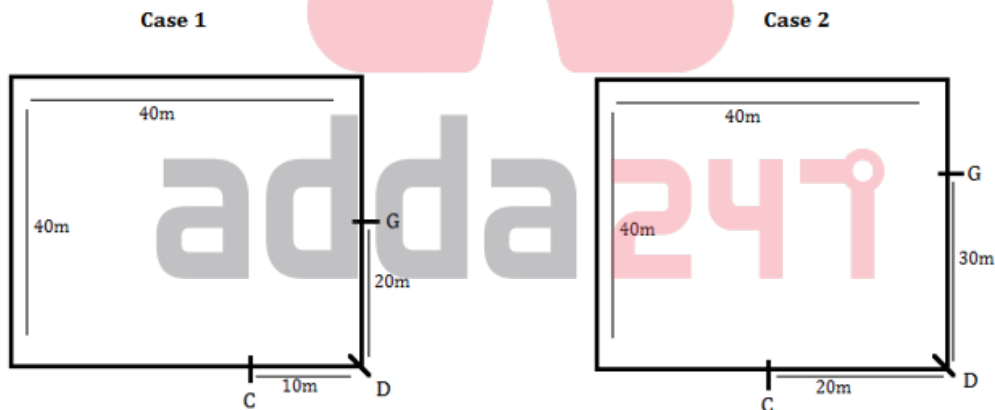

B likes Apple and sits at a distance of 10m to the right of G. E likes Guava and sits opposite to B. P likes Papaya sits 20m to the left of E.

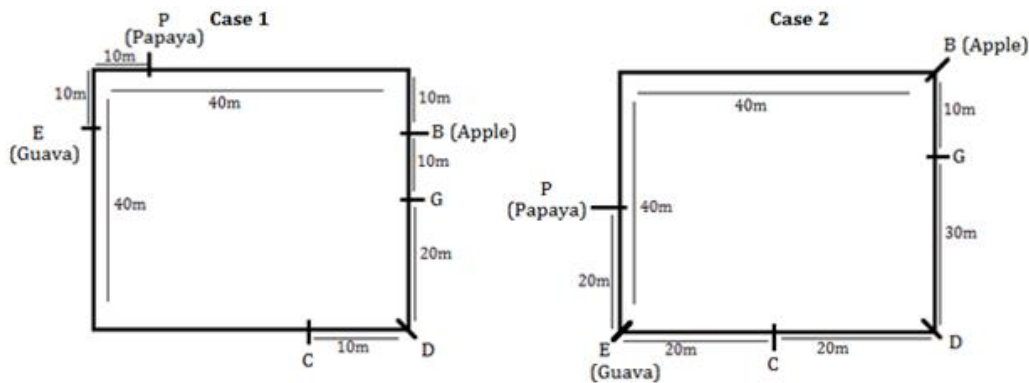

The minimum distance between E and P is same as the minimum distance between E and C. Here Case 1 is ruled out now. A likes Mango and sits 12m distance from P. Here we get one more possibility i.e. Case 2a. Three of them are sitting at the corners while rests of them are sitting on the sides of the garden. H likes Lychee and sits opposite to the midpoint of E and C.

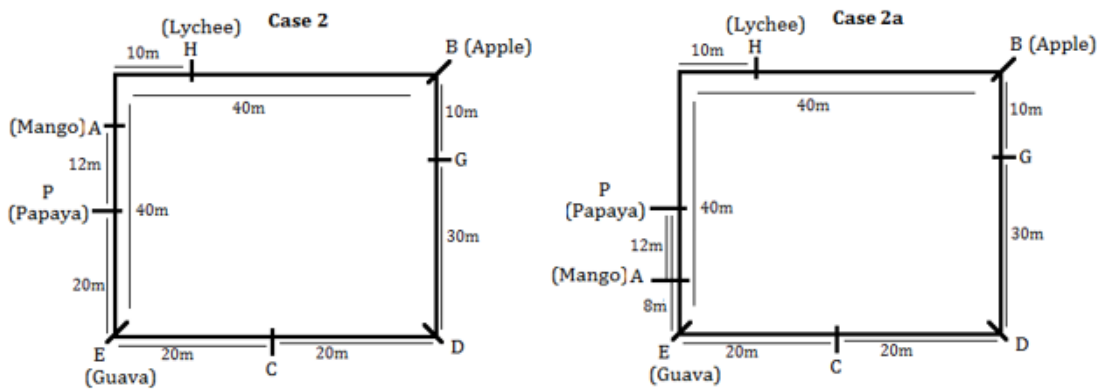

H is the neighbor of both A and F. From this condition Case 2a is ruled out now. F sits at a distance of 28m from the one who likes Grapes. According to the given statements F sits only in between H and B then only G likes Grapes. The one who likes Banana sits immediate left of the one who likes Apricot. So, the final arrangement is-

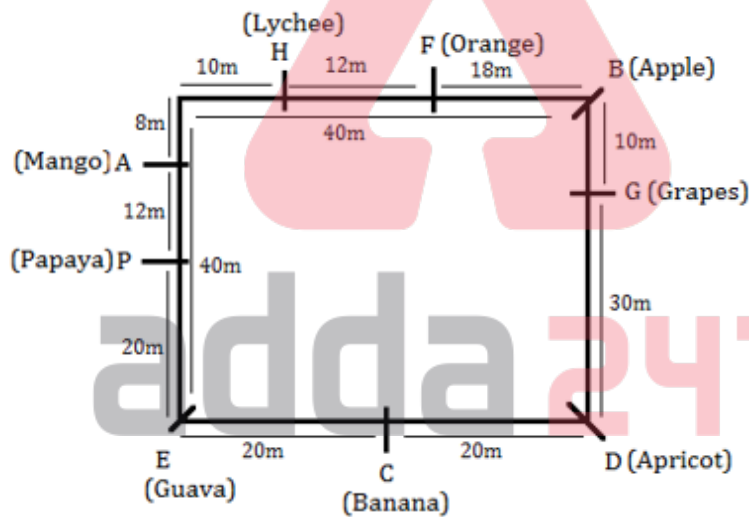

S6. Ans.(b)

Sol. Argument I is not strong because it is not directly related with the statement. Argument II is strong because it states that History should not be taught to school children in a one-sided manner and also if its content is twisted than it should be corrected.

S7. Ans.(a)

Sol. Argument I is strong because when huge quantity of cheaper Vanaspati ghee will enter in the market, then it will affect the interest of farmers and industries. Argument II is absurd, so it is not strong.

BILINGUAL

ESIC 2022
UDC & MTS
New Prelims Batch
Starts Jan 10, 2022 12 PM to 4 PM

S8. Ans.(a)

Sol. From the given statements, first we try to make blood tree between them. F is the only daughter of A. D has three children. D has only one son which means two are daughters. Someone is A's wife which means A is a male. H is the sister of B. C is married with F. E is the brother of G. C has only two sons.

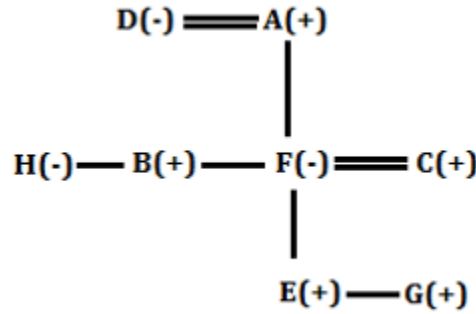

In the starters around the circular table- From the given statements, F is the only daughter of A, who takes chicken wings. Only one person sits between A and D's only son. Here we get 2 possibilities i.e. Case 1 and Case 2. D sits immediate left of B, who takes Kakaori kabab. G, who sits opposite to the one who takes Kakaori kabab. C takes Dal tikki and sits 2nd to the right of A's wife.

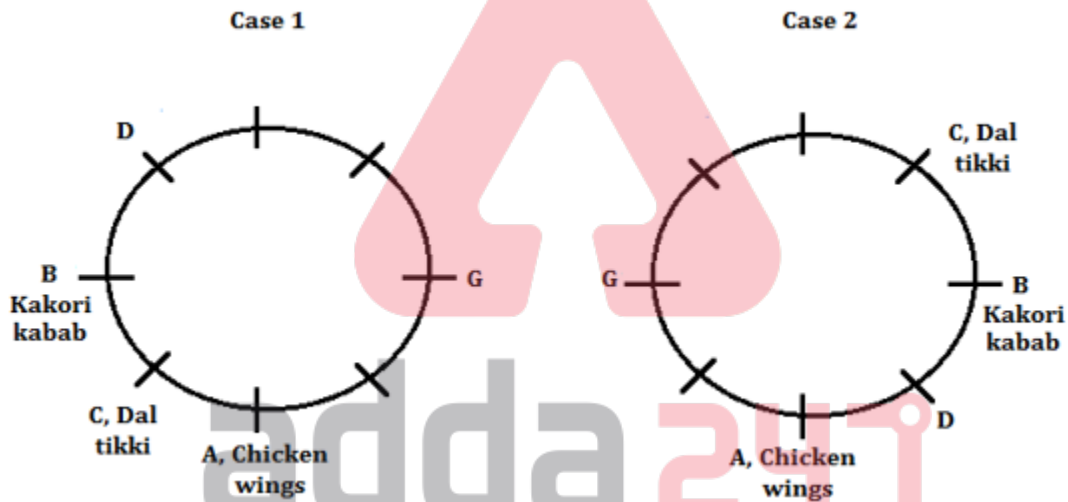

Immediate neighbors of D and G are not take Cheese balls. F, who sits immediate to the left of the one who takes Cheese balls. D doesn't take Cheese balls.

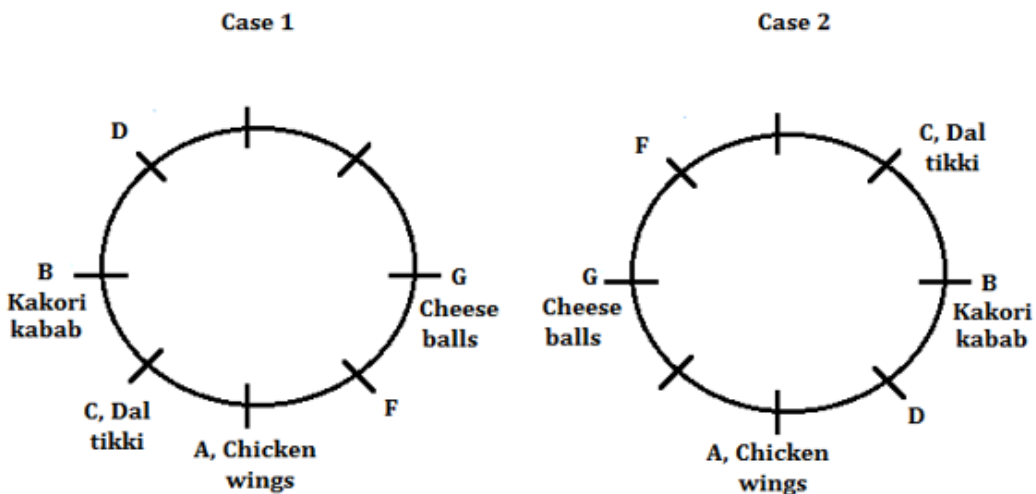

H is the sister of B and takes Tangri kabab. The one who takes Chilly chicken sits immediate left of the one who takes Veg nuggets and immediate to the right of H. Here Case 2 is ruled out now.

So, the first arrangement is –

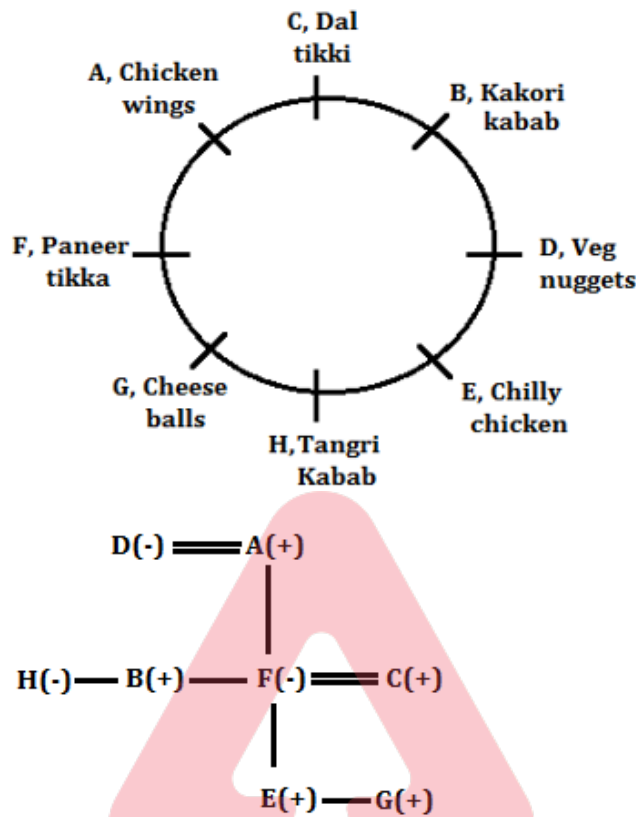

From the given statements, After the main course all they are sitting around a square table. F sits at one of the corner sides of the table and immediate neighbor of both the ones who take Khurma and Rasmalai. Here we get 2 possibilities i.e. Case 1 and Case 2. Only one person sits between G's brother, who takes Gulab jamun and the one who takes Rasmalai. The person who sits opposite of H in a circular arrangement sits opposite to F in square table.

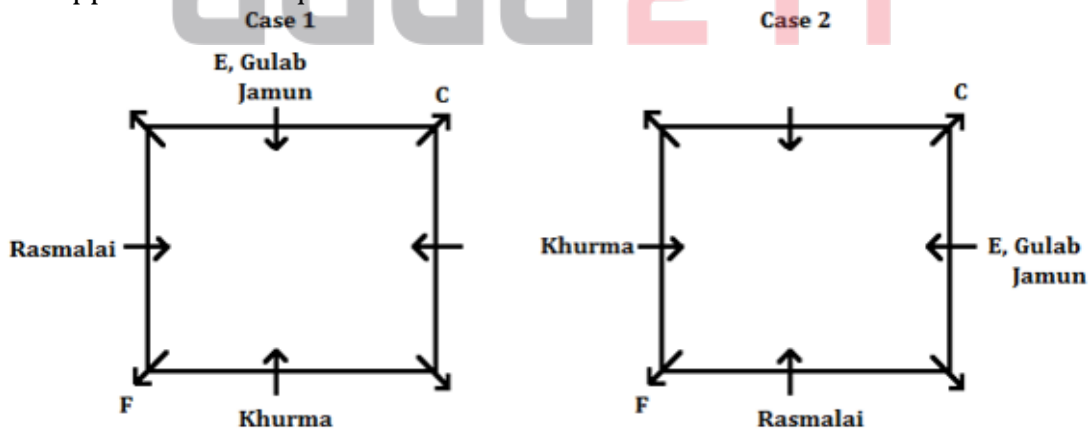

Both G and A's wife sit diagonal opposite to each other. The person who takes Rasmalai sits immediate to the left of G. From these condition Case 2 is ruled out now. A takes Jalebi. H sits 2nd to the left of B. The persons who take Basundi and Rajbhog sit diagonally opposite to each other. G takes Khaja. The person who takes Basundi sits 2nd to the right of the one who takes Ghevar.

And the 2nd final arrangement is-

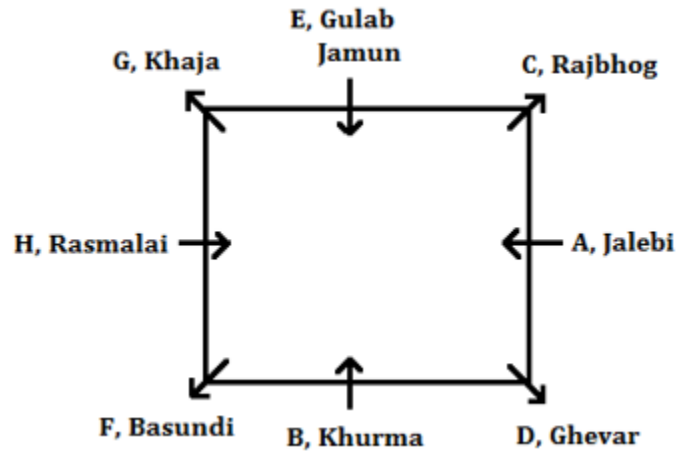

S9. Ans.(b)

Sol. From the given statements, first we try to make blood tree between them. F is the only daughter of A. D has three children. D has only one son which means two are daughters. Someone is A's wife which means A is a male. H is the sister of B. C is married with F. E is the brother of G. C has only two sons.

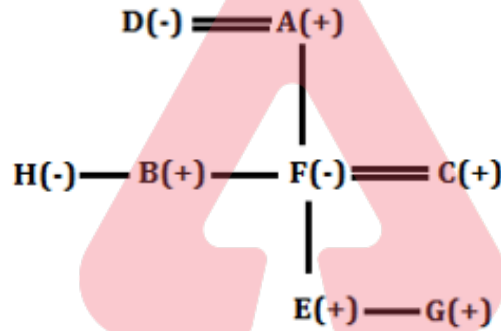

In the starters around the circular table- From the given statements, F is the only daughter of A, who takes chicken wings. Only one person sits between A and D's only son. Here we get 2 possibilities i.e. Case 1 and Case 2. D sits immediate left of B, who takes Kakaori kabab. G, who sits opposite to the one who takes Kakaori kabab. C takes Dal tikki and sits 2nd to the right of A's wife.

Case 1

Case 2

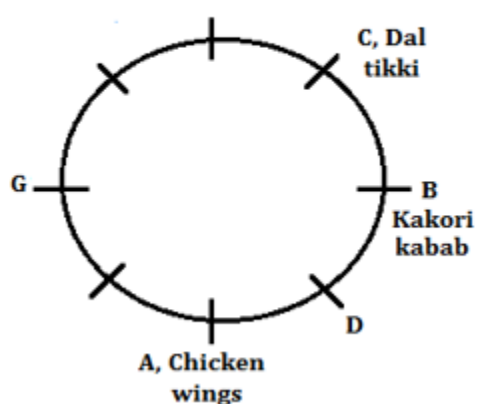
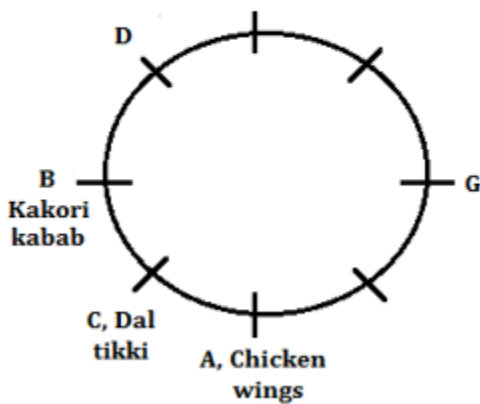

Immediate neighbors of D and G are not take Cheese balls. F, who sits immediate to the left of the one who takes Cheese balls. D doesn't take Cheese balls.

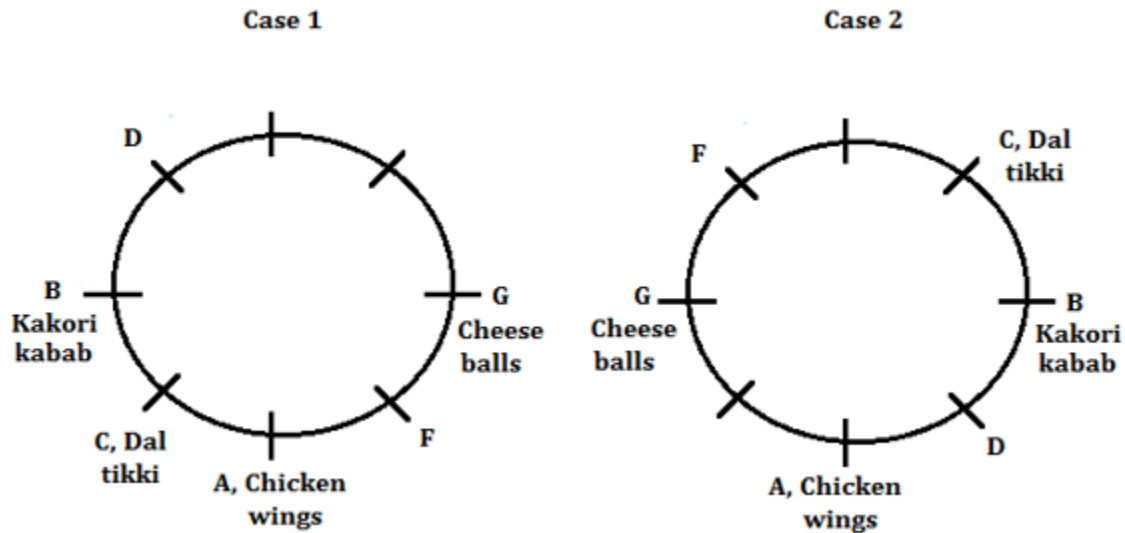

H is the sister of B and takes Tangri kabab. The one who takes Chilly chicken sits immediate left of the one who takes Veg nuggets and immediate to the right of H. Here Case 2 is ruled out now. So, the first arrangement is -

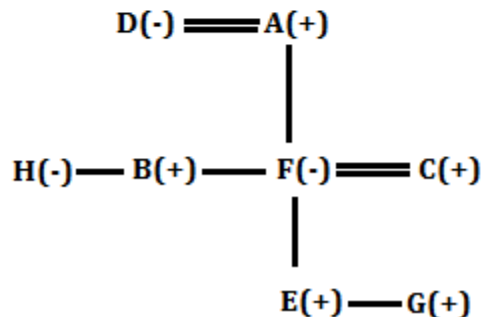
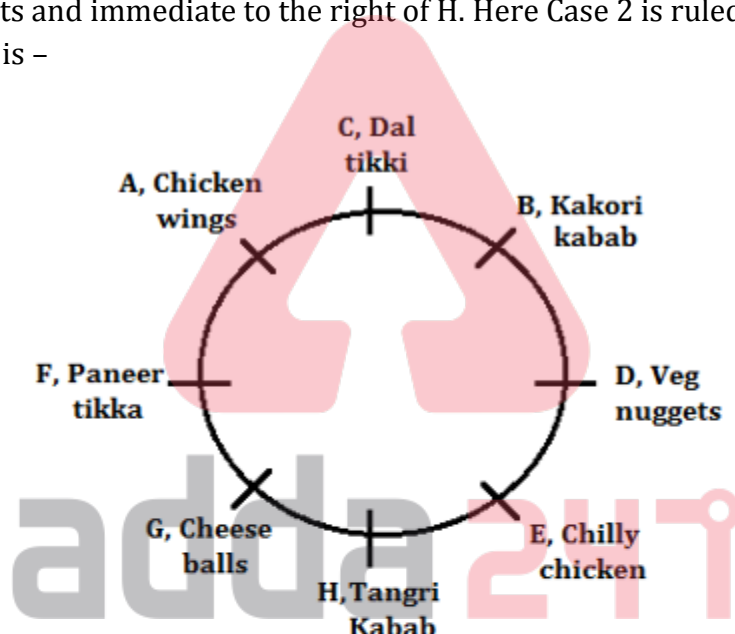

From the given statements, After the main course all they are sitting around a square table. F sits at one of the corner sides of the table and immediate neighbor of both the ones who take Khurma and Rasmalai. Here we get 2 possibilities i.e. Case 1 and Case 2. Only one person sits between G's brother, who takes Gulab jamun and the one who takes Rasmalai. The person who sits opposite of H in a circular arrangement sits opposite to F in square table.

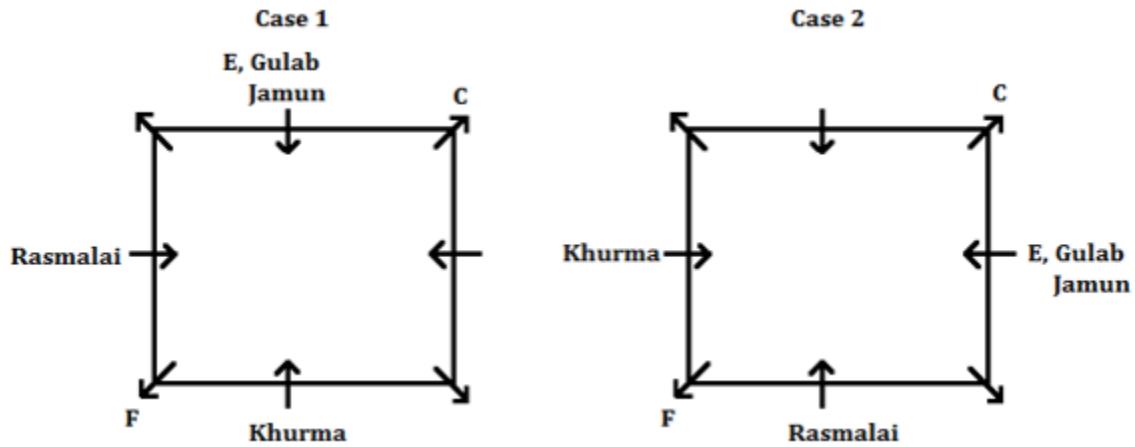

Both G and A's wife sit diagonal opposite to each other. The person who takes Rasmalai sits immediate to the left of G. From these condition Case 2 is ruled out now. A takes Jalebi. H sits 2nd to the left of B. The persons who take Basundi and Rajbhog sit diagonally opposite to each other. G takes Khaja. The person who takes Basundi sits 2nd to the right of the one who takes Ghevar.

And the 2nd final arrangement is-

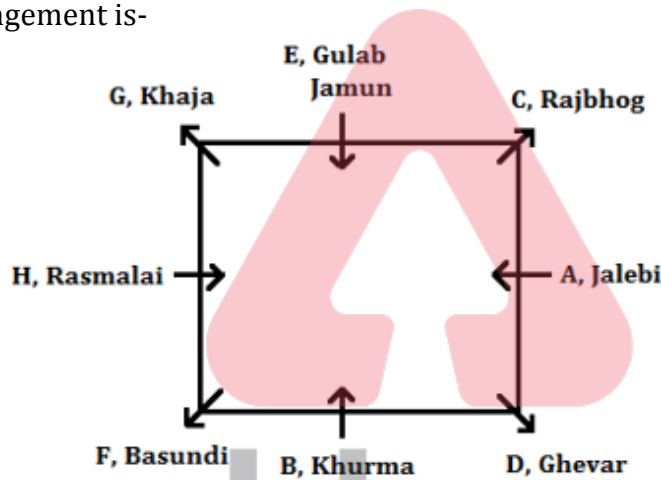

S10. Ans.(c)

Sol. From the given statements, first we try to make blood tree between them. F is the only daughter of A. D has three children. D has only one son which means two are daughters. Someone is A's wife which means A is a male. H is the sister of B. C is married with F. E is the brother of G. C has only two sons.

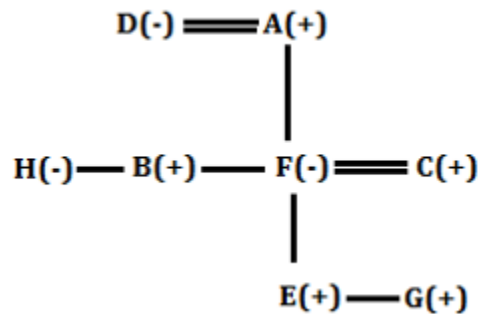

In the starters around the circular table- From the given statements, F is the only daughter of A, who takes chicken wings. Only one person sits between A and D's only son. Here we get 2 possibilities i.e. Case 1 and Case 2. D sits immediate left of B, who takes Kakaori kabab. G, who sits opposite to the one who takes Kakaori kabab. C takes Dal tikki and sits 2nd to the right of A's wife.

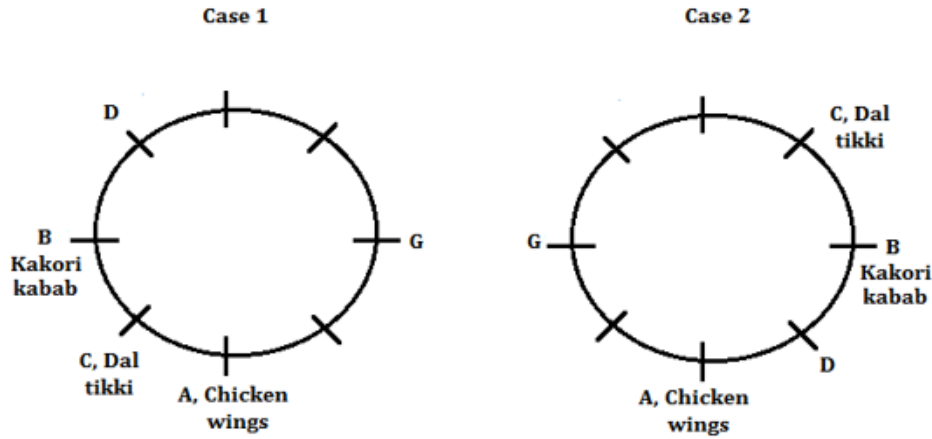

Immediate neighbors of D and G are not take Cheese balls. F, who sits immediate to the left of the one who takes Cheese balls. D doesn't take Cheese balls.

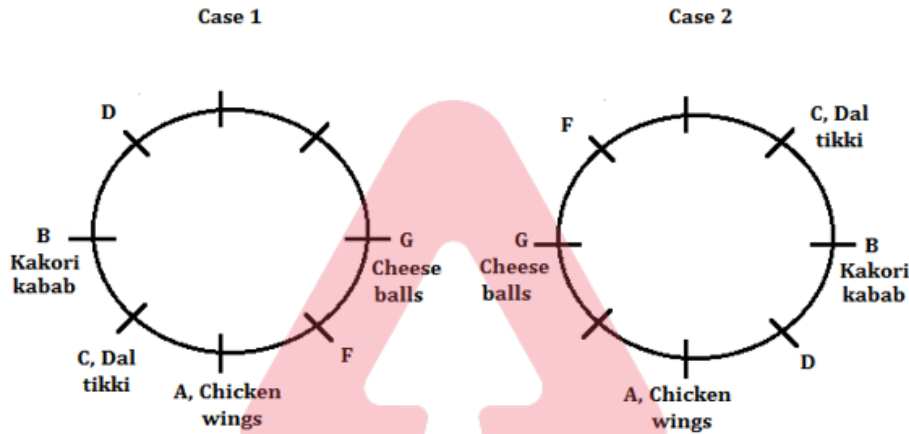

H is the sister of B and takes Tangri kabab. The one who takes Chilly chicken sits immediate left of the one who takes Veg nuggets and immediate to the right of H. Here Case 2 is ruled out now.

So, the first arrangement is -

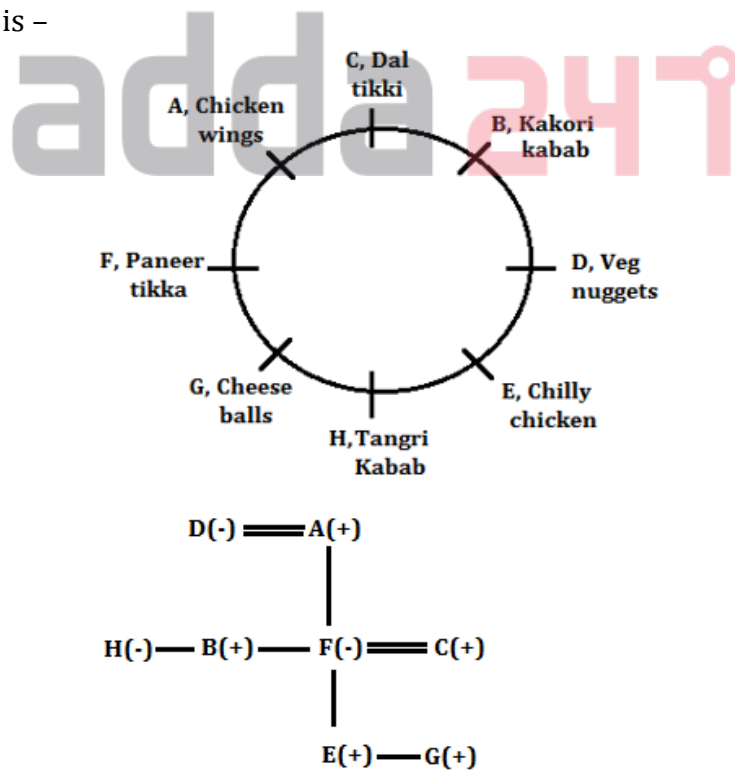

From the given statements, After the main course all they are sitting around a square table. F sits at one of the corner sides of the table and immediate neighbor of both the ones who take Khurma and Rasmalai. Here we get 2 possibilities i.e. Case 1 and Case 2. Only one person sits between G's brother, who takes Gulab jamun and the one who takes Rasmalai. The person who sits opposite of H in a circular arrangement sits opposite to F in square table.

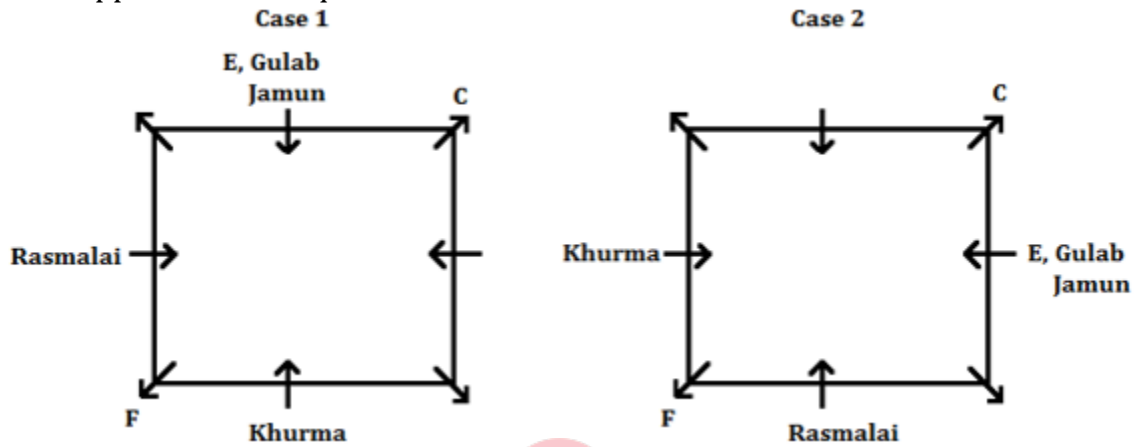

Both G and A's wife sit diagonal opposite to each other. The person who takes Rasmalai sits immediate to the left of G. From these condition Case 2 is ruled out now. A takes Jalebi. H sits 2nd to the left of B. The persons who take Basundi and Rajbhog sit diagonally opposite to each other. G takes Khaja. The person who takes Basundi sits 2nd to the right of the one who takes Ghevar.

And the 2nd final arrangement is-

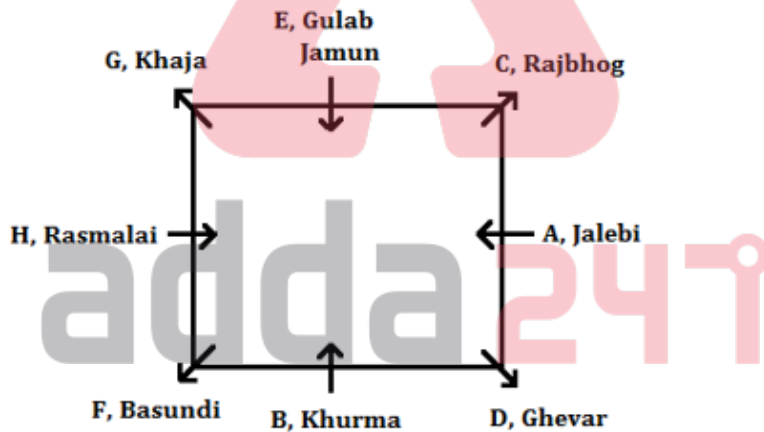

S11. Ans.(d)

Sol. From the given statements, first we try to make blood tree between them. F is the only daughter of A. D has three children. D has only one son which means two are daughters. Someone is A's wife which means A is a male. H is the sister of B. C is married with F. E is the brother of G. C has only two sons.

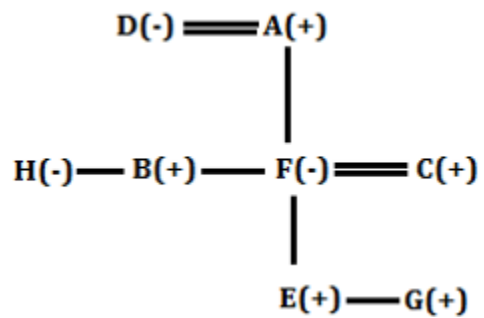

In the starters around the circular table- From the given statements, F is the only daughter of A, who takes chicken wings. Only one person sits between A and D's only son. Here we get 2 possibilities i.e. Case 1 and Case 2. D sits immediate left of B, who takes Kakaori kabab. G, who sits opposite to the one who takes Kakaori kabab. C takes Dal tikki and sits 2nd to the right of A's wife.

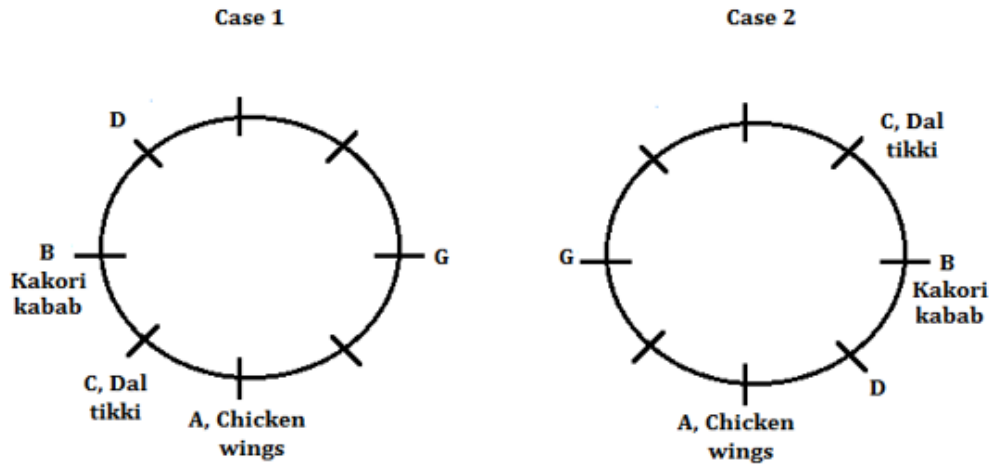

Immediate neighbors of D and G are not take Cheese balls. F, who sits immediate to the left of the one who takes Cheese balls. D doesn't take Cheese balls.

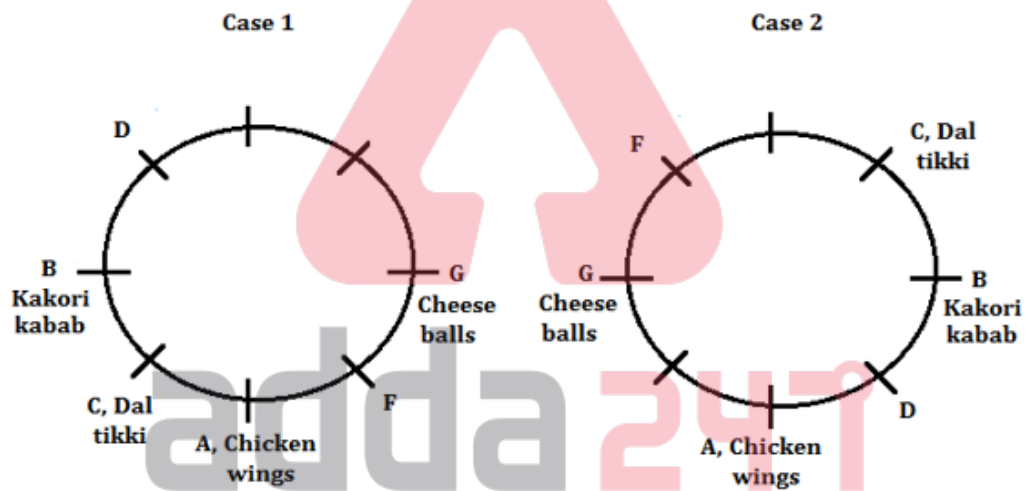

H is the sister of B and takes Tangri kabab. The one who takes Chilly chicken sits immediate left of the one who takes Veg nuggets and immediate to the right of H. Here Case 2 is ruled out now.

So, the first arrangement is –

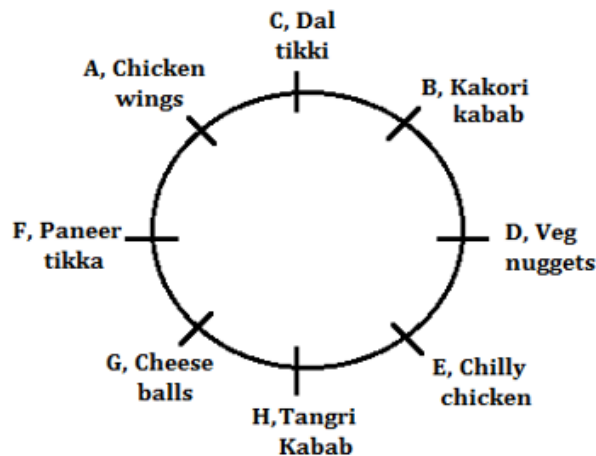

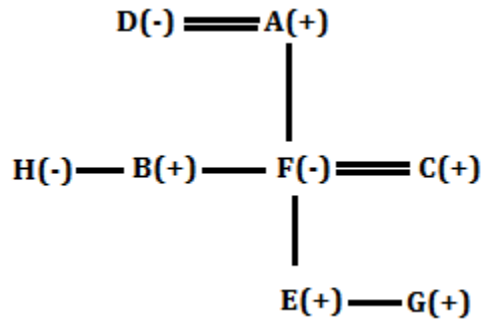

From the given statements, After the main course all they are sitting around a square table. F sits at one of the corner sides of the table and immediate neighbor of both the ones who take Khurma and Rasmalai. Here we get 2 possibilities i.e. Case 1 and Case 2. Only one person sits between G's brother, who takes Gulab jamun and the one who takes Rasmalai. The person who sits opposite of H in a circular arrangement sits opposite to F in square table.

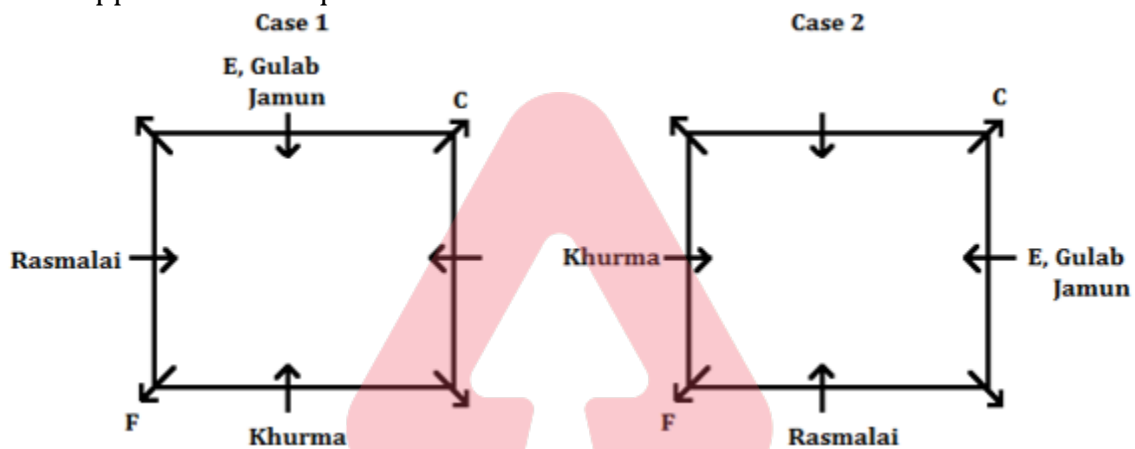

Both G and A's wife sit diagonal opposite to each other. The person who takes Rasmalai sits immediate to the left of G. From these condition Case 2 is ruled out now. A takes Jalebi. H sits 2nd to the left of B. The persons who take Basundi and Rajbhog sit diagonally opposite to each other. G takes Khaja. The person who takes Basundi sits 2nd to the right of the one who takes Ghevar. And the 2nd final arrangement is-

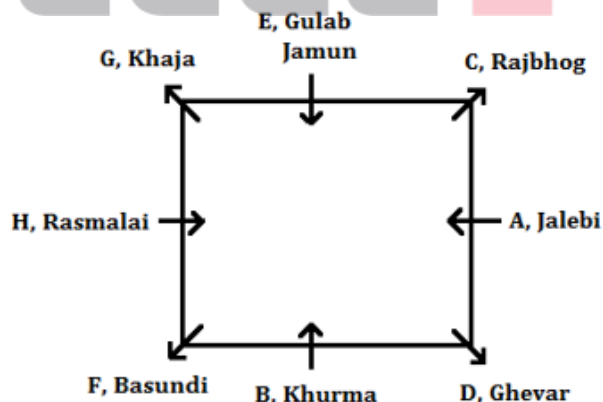

S12. Ans.(c)

Sol. From the given statements, first we try to make blood tree between them. F is the only daughter of A. D has three children. D has only one son which means two are daughters. Someone is A's wife which means A is a male. H is the sister of B. C is married with F. E is the brother of G. C has only two sons.

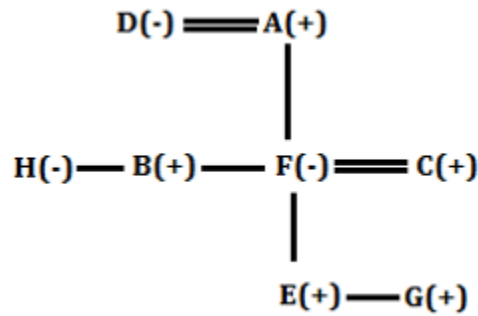

In the starters around the circular table- From the given statements, F is the only daughter of A, who takes chicken wings. Only one person sits between A and D's only son. Here we get 2 possibilities i.e. Case 1 and Case 2. D sits immediate left of B, who takes Kakaori kabab. G, who sits opposite to the one who takes Kakaori kabab. C takes Dal tikki and sits 2nd to the right of A's wife.

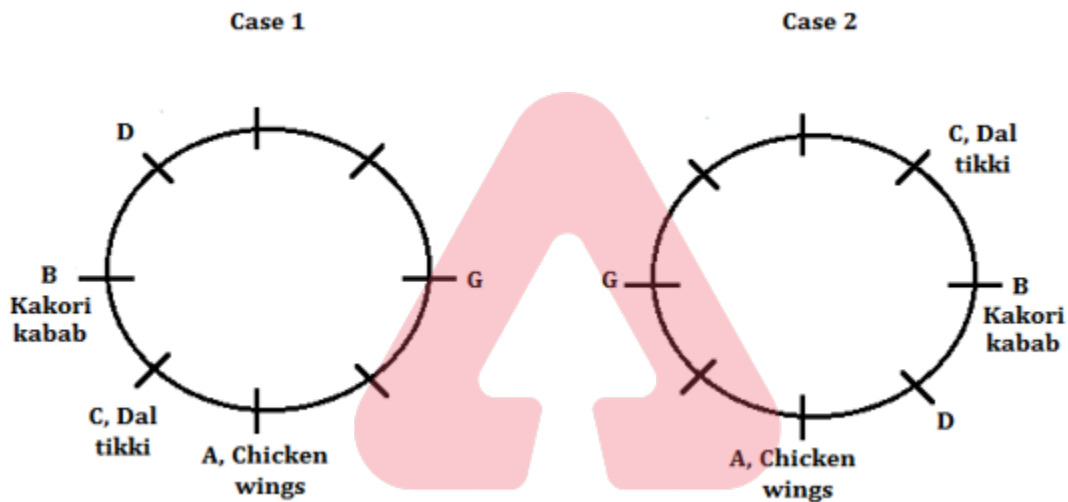

Immediate neighbors of D and G are not take Cheese balls. F, who sits immediate to the left of the one who takes Cheese balls. D doesn't take Cheese balls.

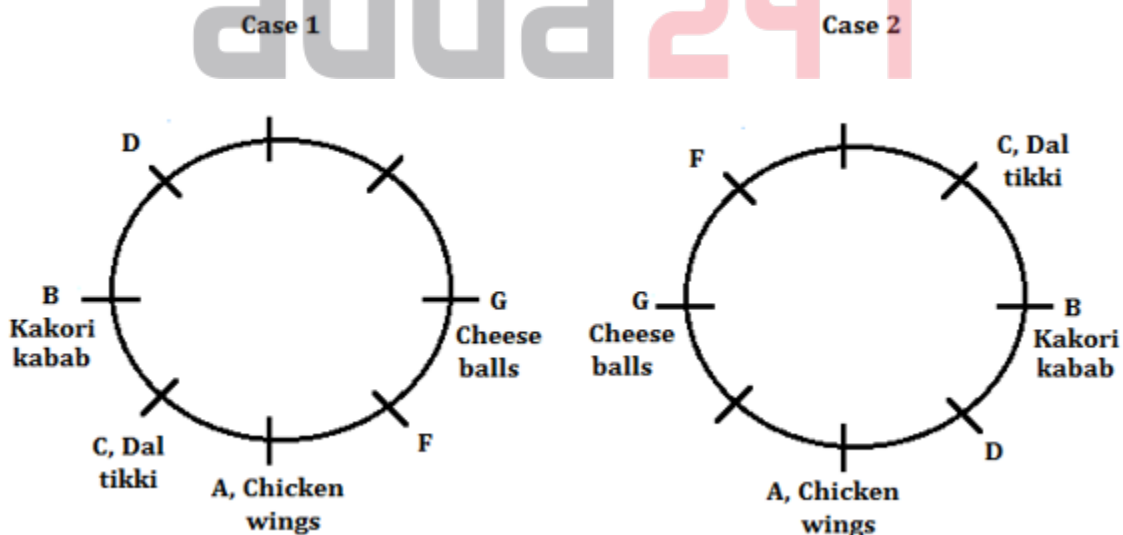

H is the sister of B and takes Tangri kabab. The one who takes Chilly chicken sits immediate left of the one who takes Veg nuggets and immediate to the right of H. Here Case 2 is ruled out now.

So, the first arrangement is –

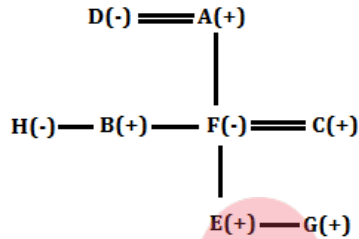
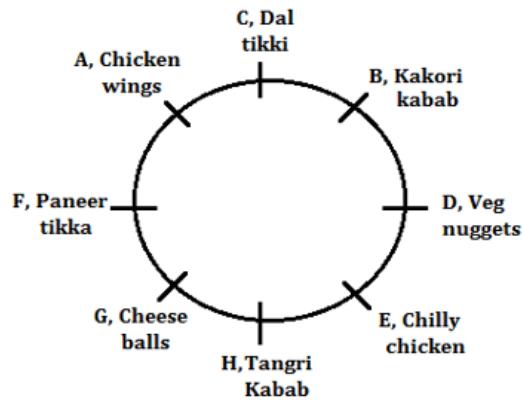

From the given statements, After the main course all they are sitting around a square table. F sits at one of the corner sides of the table and immediate neighbor of both the ones who take Khurma and Rasmalai. Here we get 2 possibilities i.e. Case 1 and Case 2. Only one person sits between G's brother, who takes Gulab jamun and the one who takes Rasmalai. The person who sits opposite of H in a circular arrangement sits opposite to F in square table.

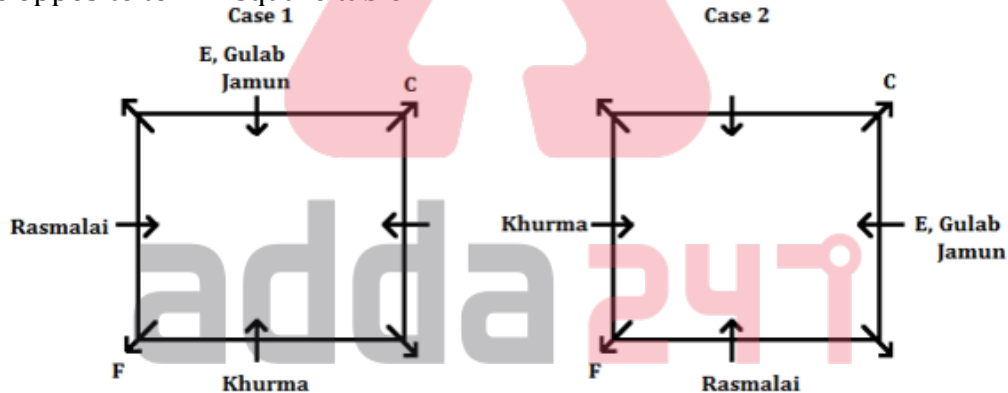

Both G and A's wife sit diagonal opposite to each other. The person who takes Rasmalai sits immediate to the left of G. From these condition Case 2 is ruled out now. A takes Jalebi. H sits 2nd to the left of B. The persons who take Basundi and Rajbhog sit diagonally opposite to each other. G takes Khaja. The person who takes Basundi sits 2nd to the right of the one who takes Ghevar. And the 2nd final arrangement is-

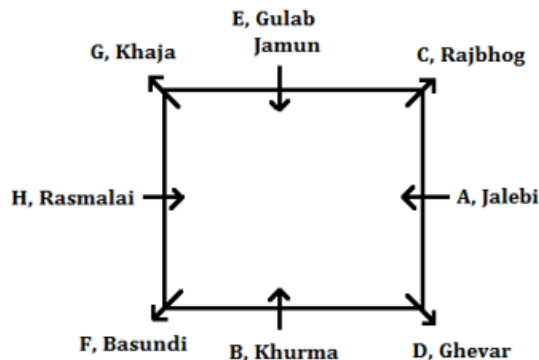

S13. Ans.(c)

Sol. From the given statements, first we try to make blood tree between them. F is the only daughter of A. D has three children. D has only one son which means two are daughters. Someone is A's wife which means A is a male. H is the sister of B. C is married with F. E is the brother of G. C has only two sons.

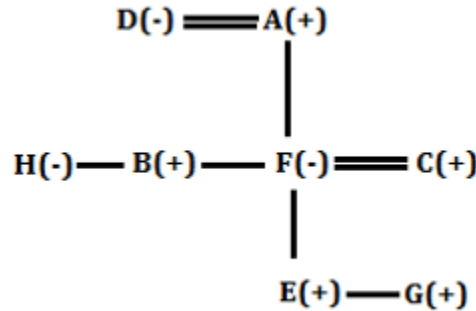

In the starters around the circular table- From the given statements, F is the only daughter of A, who takes chicken wings. Only one person sits between A and D's only son. Here we get 2 possibilities i.e. Case 1 and Case 2. D sits immediate left of B, who takes Kakaori kabab. G, who sits opposite to the one who takes Kakaori kabab. C takes Dal tikki and sits 2nd to the right of A's wife.

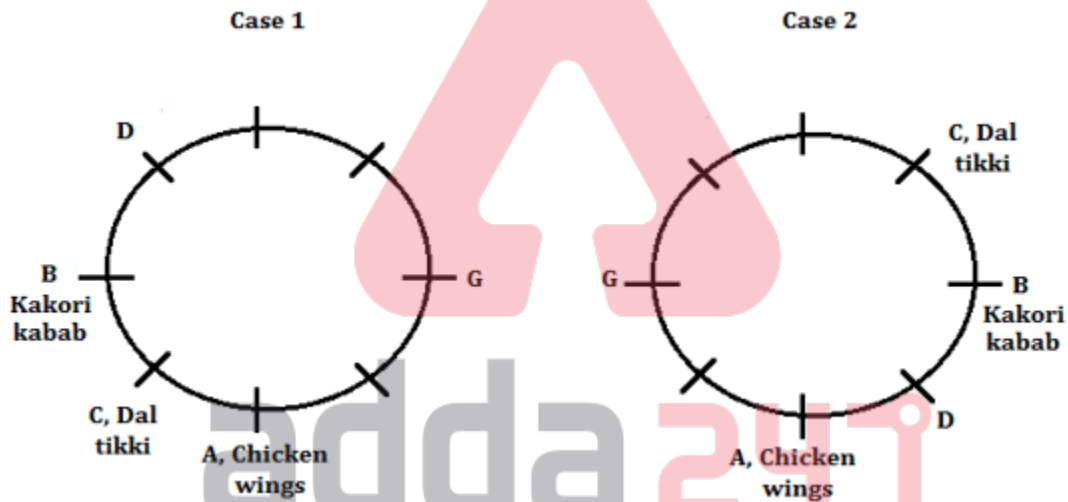

Immediate neighbors of D and G are not take Cheese balls. F, who sits immediate to the left of the one who takes Cheese balls. D doesn't take Cheese balls.

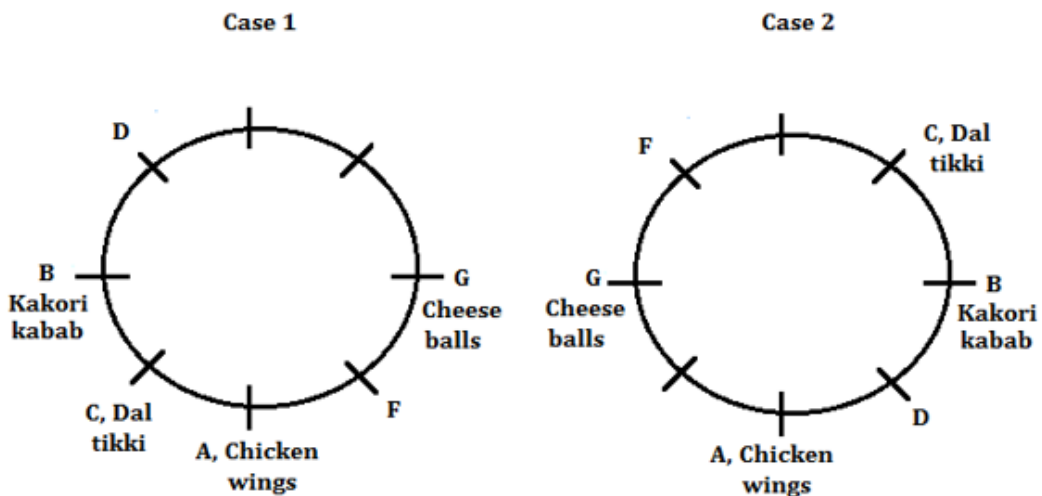

H is the sister of B and takes Tangri kabab. The one who takes Chilly chicken sits immediate left of the one who takes Veg nuggets and immediate to the right of H. Here Case 2 is ruled out now. So, the first arrangement is –

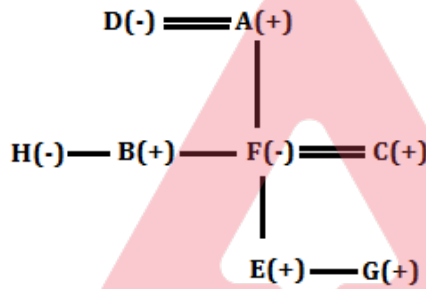
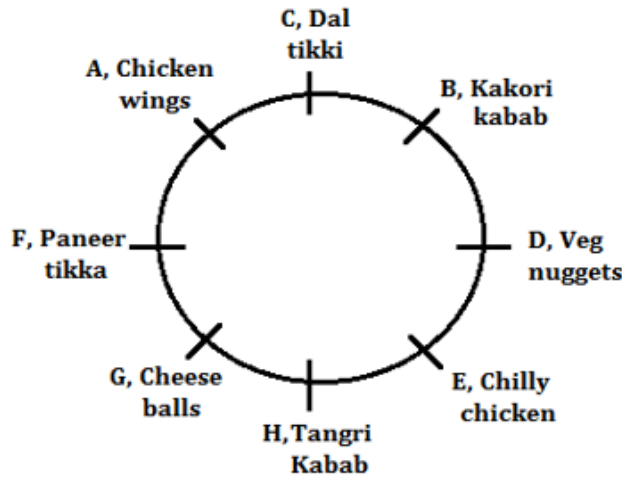

From the given statements, After the main course all they are sitting around a square table. F sits at one of the corner sides of the table and immediate neighbor of both the ones who take Khurma and Rasmalai. Here we get 2 possibilities i.e. Case 1 and Case 2. Only one person sits between G's brother, who takes Gulab jamun and the one who takes Rasmalai. The person who sits opposite of H in a circular arrangement sits opposite to F in square table.

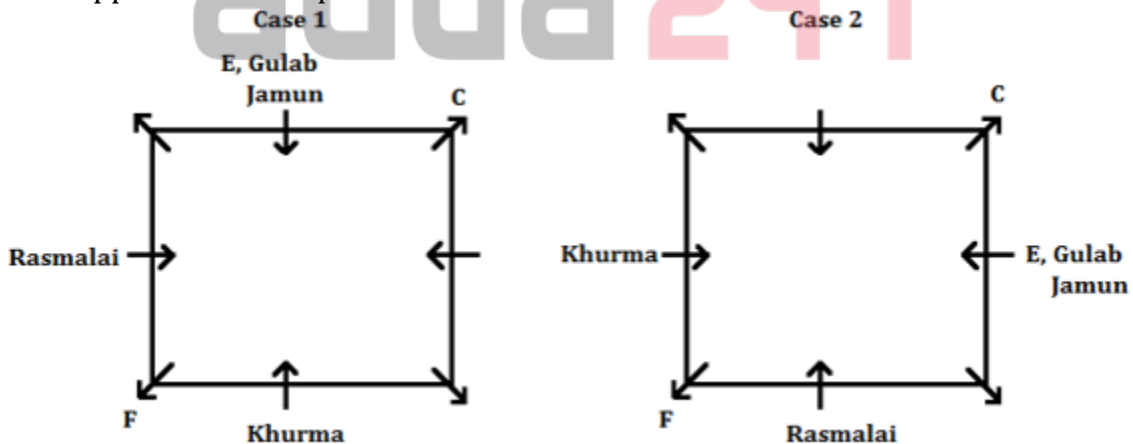

Both G and A's wife sit diagonal opposite to each other. The person who takes Rasmalai sits immediate to the left of G. From these condition Case 2 is ruled out now. A takes Jalebi. H sits 2nd to the left of B. The persons who take Basundi and Rajbhog sit diagonally opposite to each other. G takes Khaja. The person who takes Basundi sits 2nd to the right of the one who takes Ghevar.

And the 2nd final arrangement is-

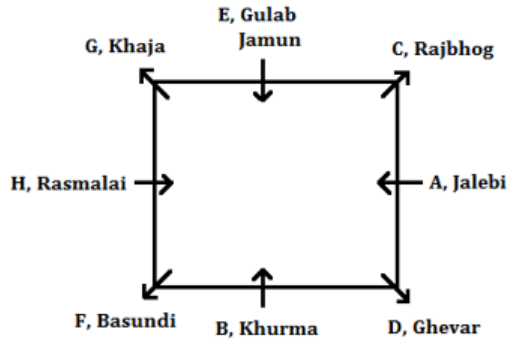

NRA-CET Ready

BANK MAHA PACK

Live Class, Video Course, Test Series, eBooks

Bilingual (with eBooks)

S14. Ans.(c)
Sol.

Car 1

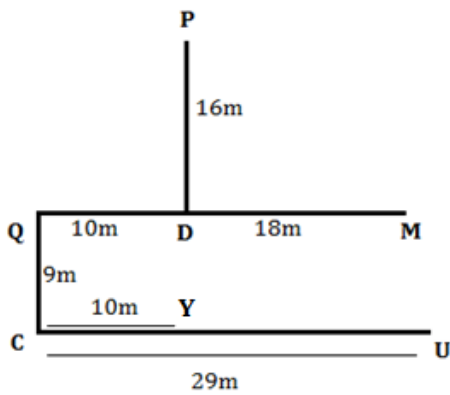

Car 2

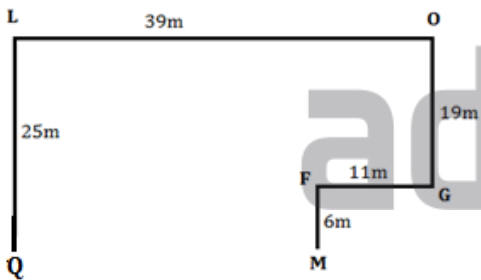

By combining the both.

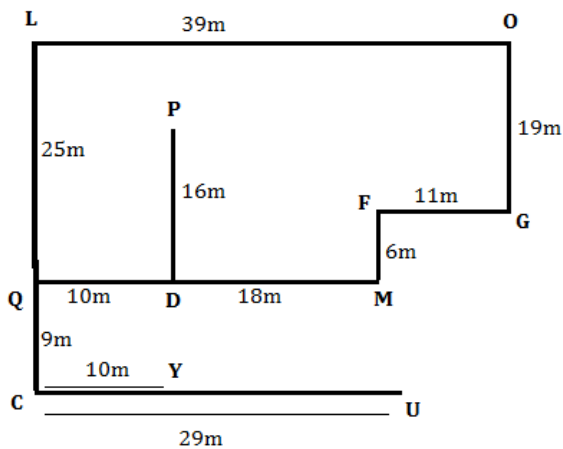

S15. Ans.(a)

Sol.

Car 1

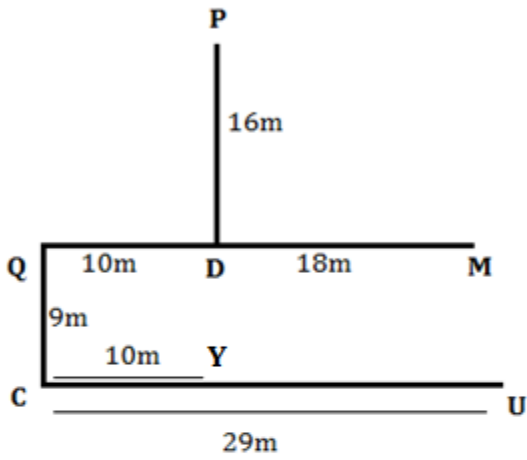

Car 2

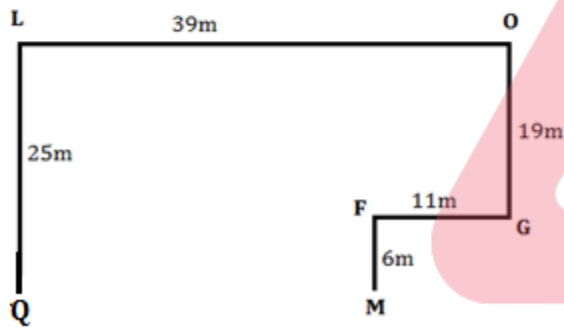

By combining the both.

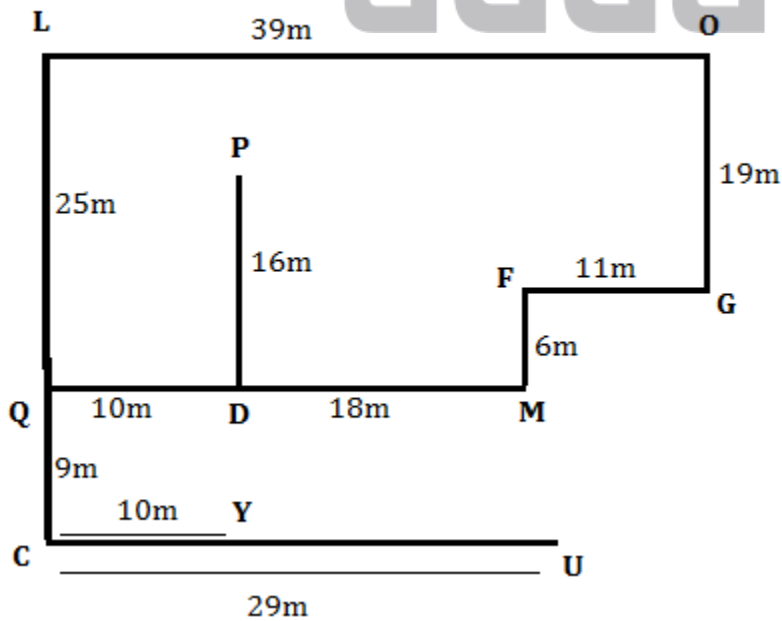

S17. Ans.(b)

Sol. From the given statements, D was born three months before the one who was born in Hyderabad. B was born after the one who was born in Hyderabad. From these conditions we get 3 possibilities i.e. Case 1, Case 2 and Case 3. More than 3 persons were born between B and A.

Months	Case 1		Case 2		Case 3	
	Persons	Cities	Persons	Cities	Persons	Cities
January	D		A		A/	
March	A		D		A/	
April		Hyderabad				
June				Hyderabad	D	
August						
September			B/			Hyderabad
November	B		B/		B	

A was born three months before the one who was born in Chennai. Here we get one more possibility i.e. Case 3a. The number of persons born before the one who was born in Chennai is the half number of persons born after F, who was born just before the one who was born in New Delhi. Here Case 1 and Case 2 are eliminated.

Months	Case 3		Case 3a	
	Persons	Cities	Persons	Cities
January	A		F	
March			A	New Delhi
April	F	Chennai		
June	D	New Delhi	D	Chennai
August				
September		Hyderabad		Hyderabad
November	B		B	

G was born in Kolkata and was born four months before the one who was born in Bangalore. Here Case 3 is ruled out now. The one who was born in Pune was born just after E. So, the final arrangement is-

Months	Persons	Cities
January	F	Mumbai
March	A	New Delhi
April	G	Kolkata
June	D	Chennai
August	C	Bangalore
September	E	Hyderabad
November	B	Pune

S18. Ans.(c)

Sol. From the given statements, D was born three months before the one who was born in Hyderabad. B was born after the one who was born in Hyderabad. From these conditions we get 3 possibilities i.e. Case 1, Case 2 and Case 3. More than 3 persons were born between B and A.

Months	Case 1		Case 2		Case 3	
	Persons	Cities	Persons	Cities	Persons	Cities
January	D		A		A/	
March	A		D		A/	
April		Hyderabad				
June				Hyderabad	D	
August						
September			B/			Hyderabad
November	B		B/		B	

A was born three months before the one who was born in Chennai. Here we get one more possibility i.e. Case 3a. The number of persons born before the one who was born in Chennai is the half number of persons born after F, who was born just before the one who was born in New Delhi. Here Case 1 and Case 2 are eliminated.

Months	Case 3		Case 3a	
	Persons	Cities	Persons	Cities
January	A		F	
March			A	New Delhi
April	F	Chennai		
June	D	New Delhi	D	Chennai
August				
September		Hyderabad		Hyderabad
November	B		B	

G was born in Kolkata and was born four months before the one who was born in Bangalore. Here Case 3 is ruled out now. The one who was born in Pune was born just after E. So, the final arrangement is-

Months	Persons	Cities
January	F	Mumbai
March	A	New Delhi
April	G	Kolkata
June	D	Chennai
August	C	Bangalore
September	E	Hyderabad
November	B	Pune

S19. Ans.(d)

Sol. From the given statements, D was born three months before the one who was born in Hyderabad. B was born after the one who was born in Hyderabad. From these conditions we get 3 possibilities i.e. Case 1, Case 2 and Case 3. More than 3 persons were born between B and A.

Months	Case 1		Case 2		Case 3	
	Persons	Cities	Persons	Cities	Persons	Cities
January	D		A		A/	
March	A		D		A/	
April		Hyderabad				
June				Hyderabad	D	
August						
September			B/			Hyderabad
November	B		B/		B	

A was born three months before the one who was born in Chennai. Here we get one more possibility i.e. Case 3a. The number of persons born before the one who was born in Chennai is the half number of persons born after F, who was born just before the one who was born in New Delhi. Here Case 1 and Case 2 are eliminated.

Months	Case 3		Case 3a	
	Persons	Cities	Persons	Cities
January	A		F	
March			A	New Delhi
April	F	Chennai		
June	D	New Delhi	D	Chennai
August				
September		Hyderabad		Hyderabad
November	B		B	

G was born in Kolkata and was born four months before the one who was born in Bangalore. Here Case 3 is ruled out now. The one who was born in Pune was born just after E. So, the final arrangement is-

Months	Persons	Cities
January	F	Mumbai
March	A	New Delhi
April	G	Kolkata
June	D	Chennai
August	C	Bangalore
September	E	Hyderabad
November	B	Pune

S20. Ans.(a)

Sol. Logic- 4529462194258474

Step 1: 5492641249524847

Step 2: 549264121468949524847

Step 3: 54926421214682694952481248487

Step 4: 54927431214783794952581258587

Numbers 5th, 8th, 15th and 21st from the right end in the Step 3 – 4, 8, 6, and 2 respectively. And the average of the numbers – $20/4=5$

S21. Ans.(e)

Sol. Logic- 4529462194258474

Step 1: 5492641249524847

Step 2: 549264121468949524847

Step 3: 54926421214682694952481248487

Step 4: 54927431214783794952581258587

S22. Ans.(b)

Sol. Logic- 4529462194258474

Step 1: 5492641249524847

Step 2: 549264121468949524847

Step 3: 54926421214682694952481248487

Step 4: 54927431214783794952581258587

4 2 6 4 2 4 2 4 8 4
2 2 2 4 4 4 4 4 6 8

S23. Ans.(a)

Sol. Logic- 4529462194258474

Step 1: 5492641249524847

Step 2: 549264121468949524847

Step 3: 54926421214682694952481248487

Step 4: 54927431214783794952581258587

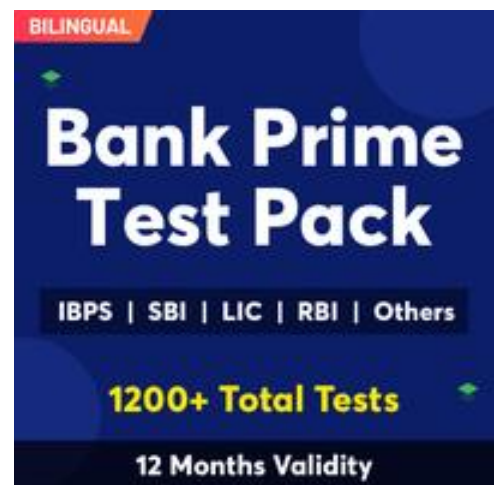

S24. Ans.(d)

Sol.

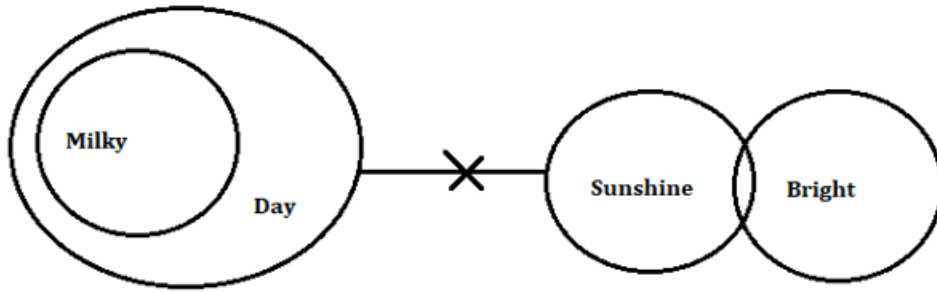

S25. Ans.(a)

Sol.

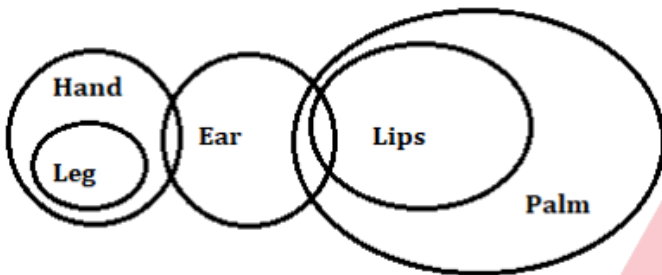

S26. Ans.(d)

Sol.

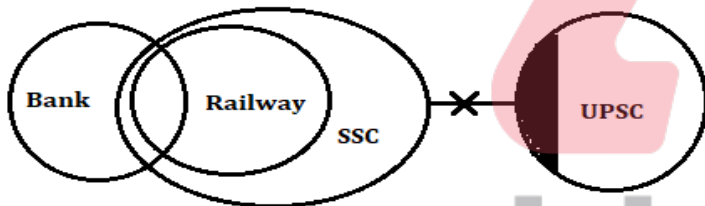

S27. Ans.(c)

Sol.

PRESIDENTIAL
OQFRJCFMSJBK
SRQOMKJJFFCB
SRQOMKCB

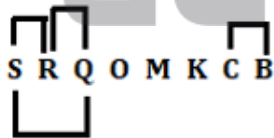

S28. Ans.(d)

Sol. From the given statements, the area of each rooms of one of the flat on the odd number floor is 840 ft. The floor having 9 rooms is one of the floors below the floor having each room area of 1080 ft. The area of each room on floor 3rd of Flat A is 1050 ft more than the area of the flat having 9 rooms.

Floors	Case 1			Case 2			Case 3		
	Flat A	Flat B	Flat C	Flat A	Flat B	Flat C	Flat A	Flat B	Flat C
3	4 rooms			4 rooms			4 rooms		
2									
1	9 rooms				9 rooms				9 rooms

There is only one floor between the floor having 2 rooms and the floor having each room area 1890 ft. So, case 1 gets eliminated. The flat having each room area 1512 ft is an even number floor. The Floor having each room area of 945 ft is kept immediately below the floor having 5 rooms.

Floors	Case 2			Case 3		
	Flat A	Flat B	Flat C	Flat A	Flat B	Flat C
3	4 rooms			4 rooms		
2			5 rooms		5 rooms	
1	2 rooms	9 rooms	8 rooms	2 rooms	8 rooms	9 rooms

Total number of Rooms in all the flats of floor 2nd is 15. Number of Rooms in Flat C of 2nd floor is more than the number of Rooms in Flat A of 2nd floor but less than the number of rooms in Flat B of 2nd floor. So, case 3 gets eliminated. The flat having each room area of 1260 ft is in the west of flat having each room area of 756 ft.

Floors	Flat A	Flat B	Flat C
3	4 rooms	6 rooms	10 rooms
2	3 rooms	7 rooms	5 rooms
1	2 rooms	9 rooms	8 rooms

S29. Ans.(a)

Sol. From the given statements, the area of each rooms of one of the flat on the odd number floor is 840 ft. The floor having 9 rooms is one of the floors below the floor having each room area of 1080 ft. The area of each room on floor 3rd of Flat A is 1050 ft more than the area of the flat having 9 rooms.

Floors	Case 1			Case 2			Case 3		
	Flat A	Flat B	Flat C	Flat A	Flat B	Flat C	Flat A	Flat B	Flat C
3	4 rooms			4 rooms			4 rooms		
2									
1	9 rooms				9 rooms				9 rooms

There is only one floor between the floor having 2 rooms and the floor having each room area 1890 ft. So, case 1 gets eliminated. The flat having each room area 1512 ft is an even number floor. The Floor having each room area of 945 ft is kept immediately below the floor having 5 rooms.

Floors	Case 2			Case 3		
	Flat A	Flat B	Flat C	Flat A	Flat B	Flat C
3	4 rooms			4 rooms		
2			5 rooms		5 rooms	
1	2 rooms	9 rooms	8 rooms	2 rooms	8 rooms	9 rooms

Total number of Rooms in all the flats of floor 2nd is 15. Number of Rooms in Flat C of 2nd floor is more than the number of Rooms in Flat A of 2nd floor but less than the number of rooms in Flat B of 2nd floor. So, case 3 gets eliminated. The flat having each room area of 1260 ft is in the west of flat having each room area of 756 ft.

Floors	Flat A	Flat B	Flat C
3	4 rooms	6 rooms	10 rooms
2	3 rooms	7 rooms	5 rooms
1	2 rooms	9 rooms	8 rooms

S30. Ans.(d)

Sol. From the given statements, the area of each rooms of one of the flat on the odd number floor is 840 ft. The floor having 9 rooms is one of the floors below the floor having each room area of 1080 ft. The area of each room on floor 3rd of Flat A is 1050 ft more than the area of the flat having 9 rooms.

Floors	Case 1			Case 2			Case 3		
	Flat A	Flat B	Flat C	Flat A	Flat B	Flat C	Flat A	Flat B	Flat C
3	4 rooms			4 rooms			4 rooms		
2									
1	9 rooms				9 rooms				9 rooms

There is only one floor between the floor having 2 rooms and the floor having each room area 1890 ft. So, case 1 gets eliminated. The flat having each room area 1512 ft is an even number floor. The Floor having each room area of 945 ft is kept immediately below the floor having 5 rooms.

Floors	Case 2			Case 3		
	Flat A	Flat B	Flat C	Flat A	Flat B	Flat C
3	4 rooms			4 rooms		
2			5 rooms		5 rooms	
1	2 rooms	9 rooms	8 rooms	2 rooms	8 rooms	9 rooms

Total number of Rooms in all the flats of floor 2nd is 15. Number of Rooms in Flat C of 2nd floor is more than the number of Rooms in Flat A of 2nd floor but less than the number of rooms in Flat B of 2nd floor. So, case 3 gets eliminated. The flat having each room area of 1260 ft is in the west of flat having each room area of 756 ft.

Floors	Flat A	Flat B	Flat C
3	4 rooms	6 rooms	10 rooms
2	3 rooms	7 rooms	5 rooms
1	2 rooms	9 rooms	8 rooms

S31. Ans.(c)

Sol. From the given statements, the area of each rooms of one of the flat on the odd number floor is 840 ft. The floor having 9 rooms is one of the floors below the floor having each room area of 1080 ft. The area of each room on floor 3rd of Flat A is 1050 ft more than the area of the flat having 9 rooms.

Floors	Case 1			Case 2			Case 3		
	Flat A	Flat B	Flat C	Flat A	Flat B	Flat C	Flat A	Flat B	Flat C
3	4 rooms			4 rooms			4 rooms		
2									
1	9 rooms				9 rooms				9 rooms

There is only one floor between the floor having 2 rooms and the floor having each room area 1890 ft. So, case 1 gets eliminated. The flat having each room area 1512 ft is an even number floor. The Floor having each room area of 945 ft is kept immediately below the floor having 5 rooms.

Floors	Case 2			Case 3		
	Flat A	Flat B	Flat C	Flat A	Flat B	Flat C
3	4 rooms			4 rooms		
2			5 rooms		5 rooms	
1	2 rooms	9 rooms	8 rooms	2 rooms	8 rooms	9 rooms

Total number of Rooms in all the flats of floor 2nd is 15. Number of Rooms in Flat C of 2nd floor is more than the number of Rooms in Flat A of 2nd floor but less than the number of rooms in Flat B of 2nd floor. So, case 3 gets eliminated. The flat having each room area of 1260 ft is in the west of flat having each room area of 756 ft.

Floors	Flat A	Flat B	Flat C
3	4 rooms	6 rooms	10 rooms
2	3 rooms	7 rooms	5 rooms
1	2 rooms	9 rooms	8 rooms

S32. Ans.(e)

Sol. From the given statements, the area of each rooms of one of the flat on the odd number floor is 840 ft. The floor having 9 rooms is one of the floors below the floor having each room area of 1080 ft. The area of each room on floor 3rd of Flat A is 1050 ft more than the area of the flat having 9 rooms.

Floors	Case 1			Case 2			Case 3		
	Flat A	Flat B	Flat C	Flat A	Flat B	Flat C	Flat A	Flat B	Flat C
3	4 rooms			4 rooms			4 rooms		
2									
1	9 rooms				9 rooms				9 rooms

There is only one floor between the floor having 2 rooms and the floor having each room area 1890 ft. So, case 1 gets eliminated. The flat having each room area 1512 ft is an even number floor. The Floor having each room area of 945 ft is kept immediately below the floor having 5 rooms.

Floors	Case 2			Case 3		
	Flat A	Flat B	Flat C	Flat A	Flat B	Flat C
3	4 rooms			4 rooms		
2			5 rooms		5 rooms	
1	2 rooms	9 rooms	8 rooms	2 rooms	8 rooms	9 rooms

Total number of Rooms in all the flats of floor 2nd is 15. Number of Rooms in Flat C of 2nd floor is more than the number of Rooms in Flat A of 2nd floor but less than the number of rooms in Flat B of 2nd floor. So, case 3 gets eliminated. The flat having each room area of 1260 ft is in the west of flat having each room area of 756 ft.

Floors	Flat A	Flat B	Flat C
3	4 rooms	6 rooms	10 rooms
2	3 rooms	7 rooms	5 rooms
1	2 rooms	9 rooms	8 rooms

S33. Ans.(e)

Sol.

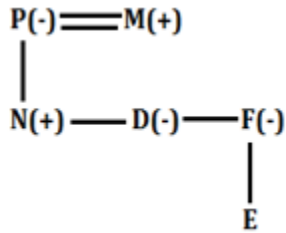

S34. Ans.(a)

Sol.

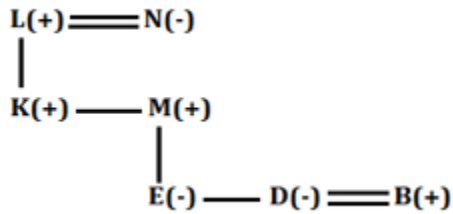

S35. Ans.(c)

Sol.

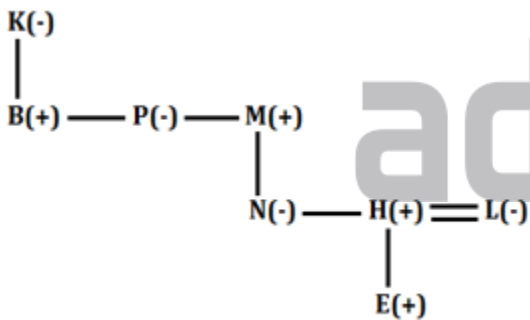

S36. Ans.(b)

Sol. In this question we have to choose that statement which can be assumed from the passage.

For Statement I: Right, As passage says that Travis Kalanick helped Uber built into colossus (enormous importance). Statement I says same thing that Travis Kalanick helped Uber built into prodigious.

For Statement II: Wrong, from passage we can't assume that shareholders forced or ordered Travis Kalanick to give-up from the post of chief executive of Uber. He stepped down as chief executive, after a seemingly endless series of scandals raised doubts over his leadership, no one forced him to do so.

For Statement III: Right, There is a sentence in a passage "Meanwhile, Shareholders released a damning report on the firm's management culture", it clarifies that the Shareholders released damning (fatal, condemnatory) report against management's culture.

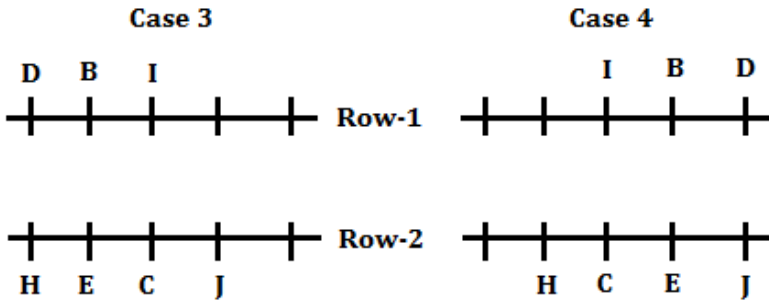

A sits to the left of I but not immediate to the left. From this condition Case 2 and Case 4 are eliminated.

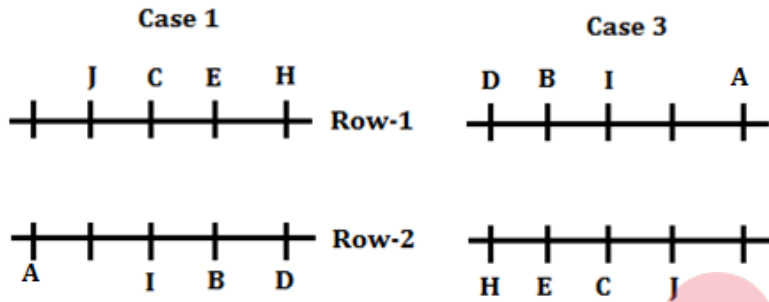

G sits to the right of A. G doesn't face in south direction. From this condition Case 3 is ruled out now. So, the final arrangement is-

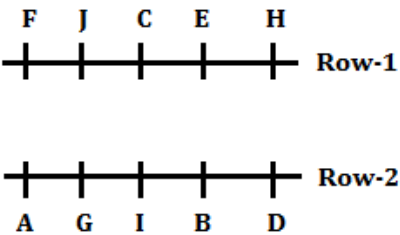

S40. Ans.(a)

Sol. From the given statements, B is the only neighbor of D. Here we have 4 possibilities i.e. Case 1, Case 2, Case 3 and Case 4. H sits 3rd to the left of J and both doesn't face B.

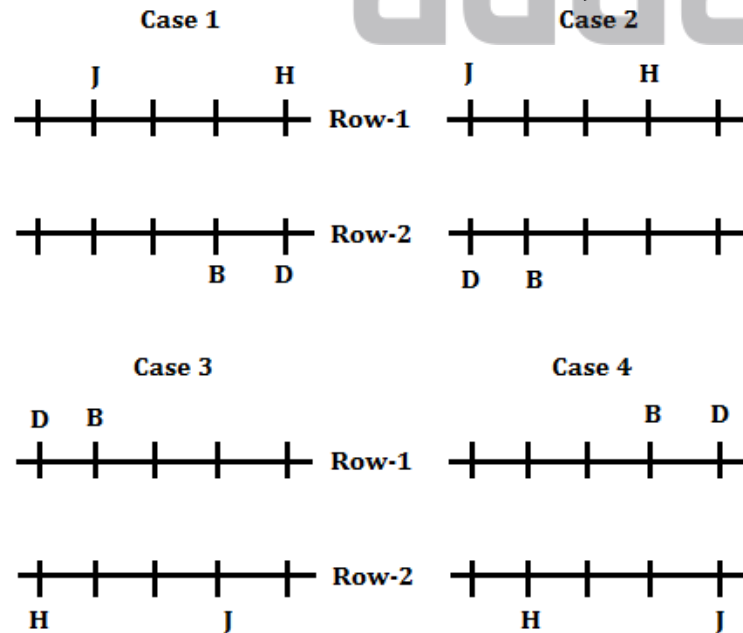

Both C and E are immediate neighbors to each other. C faces to I and doesn't sit any of the extreme ends.

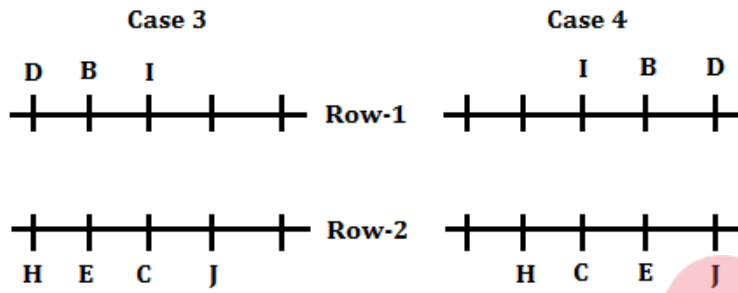
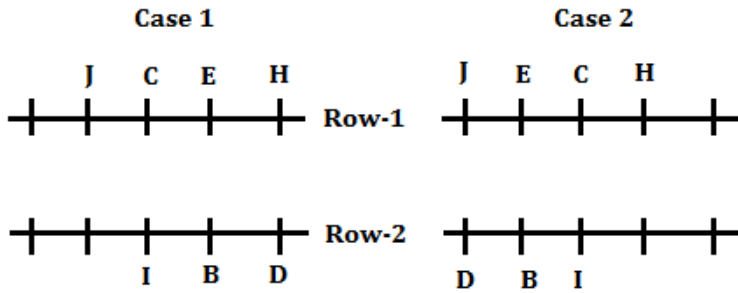

A sits to the left of I but not immediate to the left. From this condition Case 2 and Case 4 are eliminated.

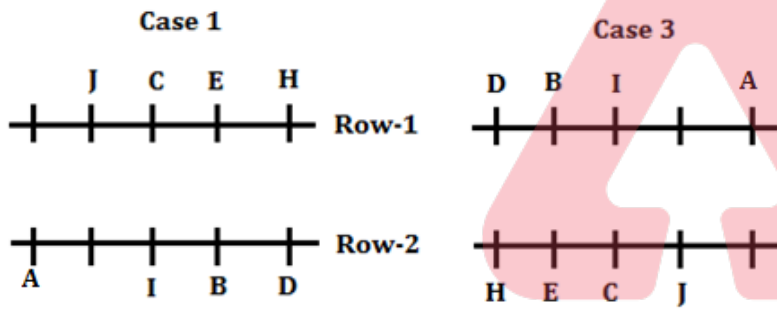

G sits to the right of A. G doesn't face in south direction. From this condition Case 3 is ruled out now. So, the final arrangement is-

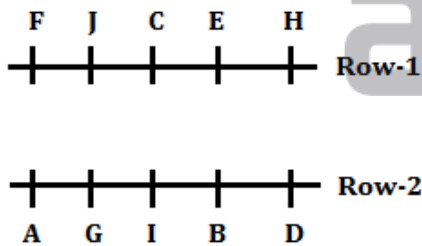

S41. Ans.(d)

Sol. From the given statements, B is the only neighbor of D. Here we have 4 possibilities i.e. Case 1, Case 2, Case 3 and Case 4. H sits 3rd to the left of J and both doesn't face B.

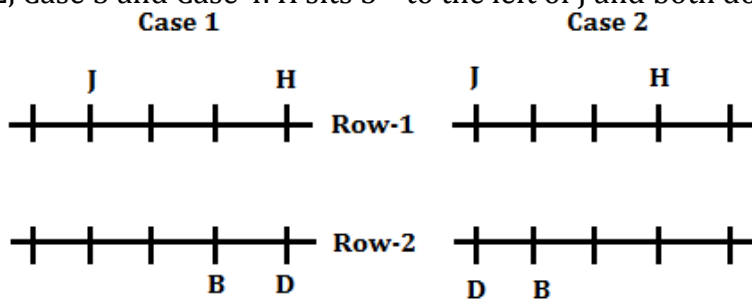

Case 3

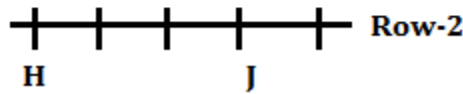
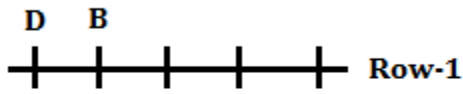

Case 4

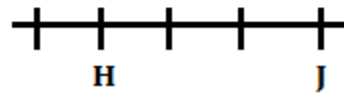
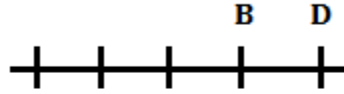

Both C and E are immediate neighbors to each other. C faces to I and doesn't sit any of the extreme ends.

Case 1

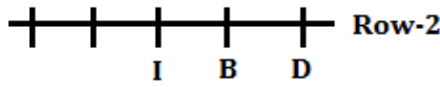
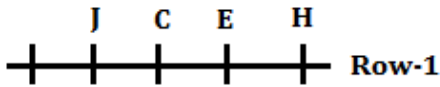

Case 2

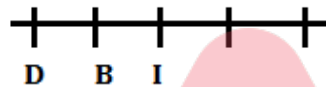
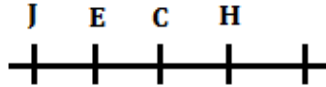

Case 3

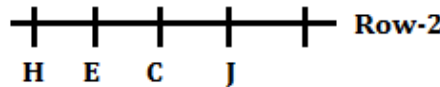
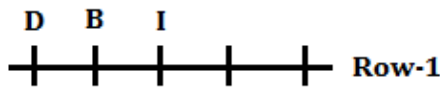

Case 4

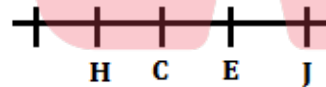
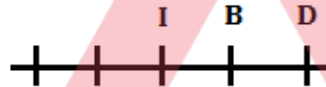

A sits to the left of I but not immediate to the left. From this condition Case 2 and Case 4 are eliminated.

Case 1

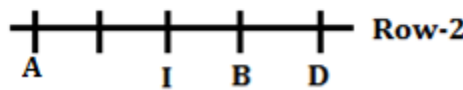
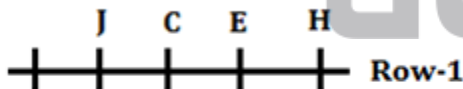

Case 3

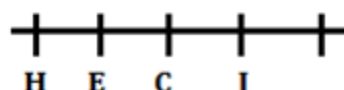
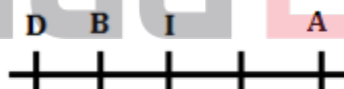

G sits to the right of A. G doesn't face in south direction. From this condition Case 3 is ruled out now. So, the final arrangement is-

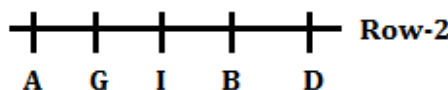
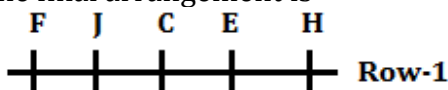

S42. Ans.(d)**Sol.** I. I & P (False)

II. Q & P (True)

III. N % B (True)

S43. Ans.(e)**Sol.** I. M & R (False)

II. O % C (False)

III. M%R (False)

S44. Ans.(b)**Sol.** I. O & C (True)

II. E & G (False)

III. E # G (False)

S45. Ans.(e)**Sol.** For I: Yes, It is strong argument as it supports the statement that by consuming an apple a day any one can keep himself fit and fine.

For II: No. It is not supporting the statement because argument II is about real juice of apple flavor but in statement consuming of apple fruit is instructed and it is also said in argument to ban it which is not in support of statement.

For III: No, It is not strong because according to statement it's an initiative from health ministry to take an apple daily but in argument III, other side of statement is shown which is not in support.

For IV: No, it is not strong with respect to statements as it's an alternative to be healthy but it is not in support of an initiative which is stated by health ministry.

S46. Ans.(b)**Sol.**male population in village A = $20 \times 300 - 2400 = 3600$ Required gender ratio = $\frac{3600}{2400} \times 100 = 150$ **S47. Ans.(d)****Sol.**

Let number of female in village A be x.

So, the number of female in village C = x

Total population of village A = 6000.

Total population of village C = 4000

ATQ,

$$\frac{(6000-x)}{x} \times 100 = \left(\frac{4000-x}{x} \times 100 \right) + 125$$

$$\Rightarrow x = 1600$$

Number of male in village C = 2400

S48. Ans.(a)**Sol.**total population of village B in 2001 = $6 \times 400 = 2400$

Total population of village E in 2001 = 9600

Population of E in 2010 = $9600 \times 1.5 = 14400$ **S49. Ans.(d)****Sol.**Total number of runs scored by Rohit with three runs = $3 \times 1200 = 3600$ Total number of two hits by Kohli = $3600 \times \frac{3}{4} \times \frac{1}{2} = 1350$

Let total number of three Hits by Dhoni be 'A'

Given, total number of runs scored by all three players with three = 11100

 $(1500 + A + 1200) \times 3 = 11100$ $3A = 11100 - 8100$ $A = 1000$ Average of total runs scored by Kohli & Rohit with one run = $\frac{3000+1500}{2} = 2250$ Total number of one run hit by Dhoni = $2250 \times \frac{6}{5} = 2700$

Let total number of four hits by Kohli be '2x'

So, total number if four hits by Rohit will be '3x'

Total runs scored by Kohli with four runs = $4 \times 2x = 8x$ Total runs scored by Dhoni with six runs = $8x \times \frac{67.5}{100} = 5.4x$

ATQ

 $5.4x = \frac{45}{100} \times 1000 \times 3$ $x = 250$ Total number of six hits by Dhoni = $\frac{250 \times 5.4}{6} = 225$ Total number of two hits by Rohit = $160 \times 6 \times \frac{100}{64} \times \frac{1}{2} = 750$ Total number of four hits by Kohli = $2 \times 250 = 500$ Total number of four hits by Rohit = $3 \times 250 = 750$

Type of runs	Kohli	Dhoni	Rohit
one runs	3000	2700	1500
two runs	1350	2400	750
three runs	1500	1000	1200
four runs	500	400	750
six runs	240	225	160
Total runs scored	13640	13450	10560

Let total number of balls faced by Kohli = $100a$

So, total number of balls faced by Rohit = $(100a + 4000)$

And, total dot balls faced by Kohli = $100a \times \frac{17.625}{100} = 17.625a$

Total scoring balls faced by Kohli = $(3000 + 1350 + 1500 + 500 + 240) = 6590$

Given, $100a - 17.625a = 6590$

$$82.375a = 6590$$

$$a = 80$$

Total balls faced by Kohli = 8000

Total balls faced by Rohit = $8000 + 4000 = 12000$

Strike rate of Kohli (V) = $\frac{13640}{8000} \times 100 = 170.5$

Strike rate of Rohit (R) = $\frac{10560}{12000} \times 100 = 88$

Required difference = $170.5 - 88 = 82.5$

S50. Ans.(a)

Sol.

Total number of runs scored by Rohit with three runs = $3 \times 1200 = 3600$

Total number of two hits by Kohli = $3600 \times \frac{3}{4} \times \frac{1}{2} = 1350$

Let total number of three Hits by Dhoni be 'A'

Given, total number of runs scored by all three players with three = 11100

$$(1500 + A + 1200) \times 3 = 11100$$

$$3A = 11100 - 8100$$

$$A = 1000$$

Average of total runs scored by Kohli & Rohit with one run = $\frac{3000+1500}{2} = 2250$

Total number of one run hit by Dhoni = $2250 \times \frac{6}{5} = 2700$

Let total number of four hits by Kohli be '2x'

So, total number of four hits by Rohit will be '3x'

Total runs scored by Kohli with four runs = $4 \times 2x = 8x$

Total runs scored by Dhoni with six runs = $8x \times \frac{67.5}{100} = 5.4x$

ATQ

$$5.4x = \frac{45}{100} \times 1000 \times 3$$

$$x = 250$$

Total number of six hits by Dhoni = $\frac{250 \times 5.4}{6} = 225$

Total number of two hits by Rohit = $160 \times 6 \times \frac{100}{64} \times \frac{1}{2} = 750$

Total number of four hits by Kohli = $2 \times 250 = 500$

Total number of four hits by Rohit = $3 \times 250 = 750$

Type of runs	Kohli	Dhoni	Rohit
one runs	3000	2700	1500
two runs	1350	2400	750
three runs	1500	1000	1200
four runs	500	400	750
six runs	240	225	160
Total runs scored	13640	13450	10560

Let total number of matches in which Kohli and Dhoni remain not out be y and $2y$ respectively
 So, total number of matches in which Kohli get out = $(225 - y)$
 And, total number of matches in which Dhoni got out = $(450 - 2y)$
 Total runs scored by Kohli = 13640
 Total runs scored by Dhoni = 13450
 ATQ -
 $\frac{13640}{225-y} - \frac{13450}{450-2y} = 34.575$
 $13640 - 6725 = 7779.375 - 34.575y$
 $6915 = 7779.375 - 34.575y$
 $y = 25$
 Required percentage = $\frac{25}{225} \times 100 = 11\frac{1}{9}\%$

S51. Ans.(a)

Sol.

Total number of runs scored by Rohit with three runs = $3 \times 1200 = 3600$
 Total number of two hits by Kohli = $3600 \times \frac{3}{4} \times \frac{1}{2} = 1350$
 Let total number of three Hits by Dhoni be 'A'
 Given, total number of runs scored by all three players with three = 11100
 $(1500 + A + 1200) \times 3 = 11100$
 $3A = 11100 - 8100$
 $A = 1000$
 Average of total runs scored by Kohli & Rohit with one run = $\frac{3000+1500}{2} = 2250$
 Total number of one run hit by Dhoni = $2250 \times \frac{6}{5} = 2700$
 Let total number of four hits by Kohli be '2x'
 So, total number if four hits by Rohit will be '3x'
 Total runs scored by Kohli with four runs = $4 \times 2x = 8x$
 Total runs scored by Dhoni with six runs = $8x \times \frac{67.5}{100} = 5.4x$
 ATQ
 $5.4x = \frac{45}{100} \times 1000 \times 3$
 $x = 250$
 Total number of six hits by Dhoni = $\frac{250 \times 5.4}{6} = 225$
 Total number of two hits by Rohit = $160 \times 6 \times \frac{100}{64} \times \frac{1}{2} = 750$
 Total number of four hits by Kohli = $2 \times 250 = 500$
 Total number of four hits by Rohit = $3 \times 250 = 750$

Type of runs	Kohli	Dhoni	Rohit
one runs	3000	2700	1500
two runs	1350	2400	750
three runs	1500	1000	1200
four runs	500	400	750
six runs	240	225	160
Total runs scored	13640	13450	10560

Let total number of dot balls faced by Dhoni be 'N'

Total balls at which Rohit scored = 4360

$$\text{Strike rate of Rohit} = \frac{10560}{4360+3640} = 132$$

Strike rate of Dhoni = $132 + 2.5 = 134.5$

Total balls at which Dhoni scored = 6725

ATQ -

$$\text{Total balls faced by Dhoni} = \frac{13450}{134.5} \times 100 = 10000$$

Total dot balls played by Dhoni (N) = $10000 - 6725 = 3275$

$$\text{Total innings played by Dhoni} = \frac{10000}{50} = 200$$

$$\text{Batting average of Dhoni} = \frac{13450}{160} = 84.0625$$

Batting average of Rohit = $84.0625 - 18.0625 = 66$

$$\text{Total innings played by Rohit} = \frac{10560}{66} + 50 = 160 + 50 = 210$$

Required difference = $3275 - 210 = 3065$

S52. Ans.(e)

Sol.

	Veer :	Satish :	Yogesh
From A and C)	6×12	8×9	9×8
	72	72	72
	1	1	1
Share of Veer = Share of Satish Rs 900			
	Satish		Veer
From (B and C)	8000×9		6000×12
	1		1

Share of Veer share of Satish = Rs 900

Either A and C or B and C question can be solved.

S53. Ans.(c)

Sol.

Let the required number be $(10x + y)$ where x is the ten's digit and y is the unit's digit

$$\text{From A} = x^2 + y^2 = 26$$

$$\text{From B} = (10x + y) : (x + y) = 5 : 2$$

$$\text{From C} = x = y - 4$$

$$y - x = 4$$

S54. Ans.(d)

Sol.

Let the total work be 100 units

Work done by Chiru alone in 1 day is more than 4 units

Work done by Binny and Chiru together in 1 day = 6 units

⇒ work done by Binny alone in 1 day is less than 2 units

Maximum units of work done by Deep in 1 day = 3 units

So, Binny and Deep together will do less than 5 units in a day

So, required days (Z) will be greater than $\frac{100}{5} = 20$ days

S55. Ans.(b)**Sol.**

Let first two terms be a and b

As $t_{n+2} = t_{n+1} - t_n$

Then $t_3 = b - a$, $t_4 = -a$, $t_5 = -b$, $t_6 = a - b$, $t_7 = a$ and $t_8 = b$

Therefore, the terms are repeating after every 6 terms i.e $t_1 = t_7 = t_{13} = a$

$t_1 = t_2 - t_3$

$t_2 = t_3 - t_4$

$t_3 = t_4 - t_5$

$t_n = t_{n+1} - t_{n+2}$

$S_n = t_1 + t_2 + t_3 + \dots + t_n = t_2 - t_{n+2}$

$S_{2092} = t_2 - t_{2094} = 1985$

$S_{1985} = t_2 - t_{1987} = 2092$

$t_{2094} = t_6 = a - b$ (as 2094 is divisible by 6)

$t_{1987} = t_1 = a$ (when 1987 is divided by 6, it gives 1 as remainder)

$b - (a - b) = 1985 \dots \dots \dots (i)$

and $b - a = 2092 \dots \dots \dots (ii)$

From (i) and (ii)

$b = -107$

$S_{3333} = t_2 - t_{3335} = t_2 - t_5 = b - (-b) = 2b = -214$

S56. Ans.(e)**Sol.**Let speed of current in Yamuna be $5a$ km/hr. and speed of boat in still water be y km/hr.

So, speed of current in Ganga = $5a \times \frac{60}{100} = 3a$ km/hr.

ATQ,

$(3a + y) \times 10 = (y - 5a) \times 18$

$30a + 10y = 18y - 90a$

$\Rightarrow 120a = 8y$

$\Rightarrow \frac{a}{y} = \frac{1}{15}$

Let a & y be p & $15p$ respectively.

So, speed of boat in still water = $y = 15p$ km/hr

And, speed of current in Ganga = $3a = 3p$ km/hr

Hence, speed of boat in still water is 5 times of speed

of current in Ganga and only (40 & 8) & (20 & 4) satisfy this condition.

S57. Ans.(b)**Sol.**

A	B	C	D	E	F	G	H
2.625km	7.875km	4.375km	7km	4.375 km	8.75km	7km	4.375km
4 h 12 min	3 h	4 h 48 min	3 h	4 h 48 min	3 h 36 min	2 h 24 min	4 h 48 min

Speed at which Veer travels to H's house = $\frac{4.375}{4.8} = \frac{4375}{4800} \text{ km/hr}$

Time taken to reach F's house = $\frac{8.75}{4375} \times 4800 = 9.6 \text{ hr}$

Required time = $9.6 - \frac{8.75}{3.6} = 6 \text{ hr}$

S58. Ans.(b)

Sol.

A	B	C	D	E	F	G	H
2.625km	7.875km	4.375km	7km	4.375 km	8.75km	7km	4.375km
4 h 12 min	3 h	4 h 48 min	3 h	4 h 48 min	3 h 36 min	2 h 24 min	4 h 48 min

Case I: A's house Veer's house B's house
 Total distance travelled by Veer in order to reach B's house = 2(distance between A's and Veer's house) + (distance between Veer's and B's house) = $2 \times 2.625 + 7.875 = 13.125 \text{ km}$
 Required time = $\frac{13.125}{1.5} \text{ hr} = 8.75 \text{ hr}$

Case II: Veer's house A's house B's house
 Total distance travelled by Veer in order to reach B's house = (Distance between Veer's and A's house) + (Distance between A's and B's house) = Distance between Veer's and B's house = 7.875 km
 Required time = $\frac{7.875}{1.5} = 5.25 \text{ hr}$
 Required average = $\frac{8.75+5.25}{2} = 7 \text{ hr}$

S59. Ans.(e)

Sol.

A	B	C	D	E	F	G	H
2.625km	7.875km	4.375km	7km	4.375 km	8.75km	7km	4.375km
4 h 12 min	3 h	4 h 48 min	3 h	4 h 48 min	3 h 36 min	2 h 24 min	4 h 48 min

Total distance travelled by Veer in order to reach F's house from E's house = Distance between Veer's and F's house + distance between Veer's and E's house = $8.75 + 4.375 = 13.125 \text{ km}$

Speed at which he travels to B's house = $\frac{7.875}{3} = 2.625 \text{ km/h}$

Required time = $\frac{13.125}{2.625} = 5 \text{ hr}$

S60. Ans.(d)**Sol.**From I: $726=2 \times 3 \times 11^2$ Here the sum of factors= $2+3+11=16 (<20)$ Number of divisors= $2 \times 2 \times 3 = 12$

This is one of the possible values of N.

From II: $294=2 \times 3 \times 7^2$ Here the sum of factors= $2+3+7=12 (<20)$ Number of divisors= $2 \times 2 \times 3 = 12$

This is one of the possible values of N.

From III: $252=2^2 \times 3^2 \times 7$ Here the sum of factors= $2+3+7=12 (<20)$ Number of divisors= $3 \times 3 \times 2 = 18$

This is not the possible values of N.

From IV: $440=2^3 \times 5 \times 11$ Here the sum of factors= $2+5+11=18 (<20)$ Number of divisors= $4 \times 2 \times 2 = 16$

This is not the possible values of N.

From V: $198=2 \times 3^2 \times 11$ Here the sum of factors= $2+3+11=16 (<20)$ Number of divisors= $2 \times 3 \times 2 = 12$

This is one of the possible values of N.

So, I, II and IV are possible values of N.

S61. Ans.(e)**Sol.**The total number of possible trails= $9P4=3024$

If he gets success in nth trail means he has failed in earlier (n-1) trails and will not try any of failed trails.

Probability of success in the nth trials alone= $\frac{1}{3025-n}$ i.e. $\frac{3023}{3024} \times \frac{3022}{3023} \times \frac{3021}{3022} \times \dots \times \frac{3025-n}{3026-n} \times \frac{1}{3025-n} = \frac{1}{3024}$ Hence, probability of success in any trail= $\frac{1}{3024}$ **S62. Ans.(e)****Sol.**

Let's assume that the rectangle has m and n tiles along its length and breadth respectively.

The number of white tiles $W = 2m + 2(n - 2) = 2(m + n - 2)$ The number of red tiles $R = (m - 2)(n - 2) = mn - 2m - 2n + 4$

ATQ

$$\Rightarrow 4m + 4n - 8 = mn - 2m - 2n + 4$$

$$\Rightarrow mn - 6m - 6n + 12 = 0$$

$$\Rightarrow (m - 6)(n - 6) - 36 + 12 = 0$$

$$\Rightarrow (m - 6)(n - 6) = 24$$

As m and n are integers, both (m - 6) and (n - 6) are integers as well. The possible sets of values where m, n are positive integers:

$$(m - 6, n - 6) = (24, 1), (12, 2), (8, 3), (6, 4)$$

$$\text{So } (m, n) = (30, 7), (18, 8), (14, 9), (12, 10)$$

$$\text{The possible difference} = R - W = 2W - W = W$$

$$\text{Possible difference} = 70, 48, 42, 40$$

S63. Ans.(b)

Sol.

Quantity I - 'T' series will be , 2, 3, 5, 7, 11 & 13

Number of ways to picking five numbers at random = ${}^6C_5 = 6$

Possible cases = (3, 5, 7, 11, 13), (2, 3, 7, 11, 13) & (2, 3, 5, 7, 13)

Required probability = $\frac{3}{6} = 0.5$

2400% of probability of sum of these five picking numbers divisible by 3 = $0.5 \times \frac{2400}{100} = 12$

Quantity II -

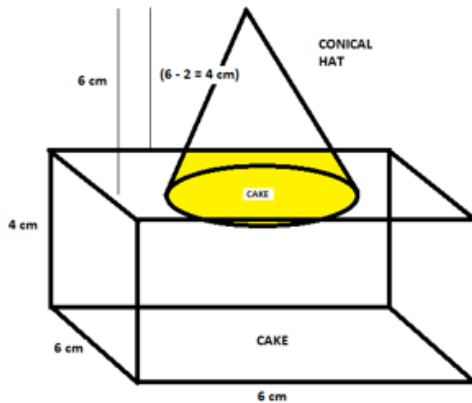

Given, cake rises to height of 2 cm inside the cap.

Let, radius of top surface (conical) cake inside the cap be 'r' cm

The shaded region is now a frustum of height 2 cm and radius of top & bottom be 'r' cm & 4 cm respectively.

In case of frustum,

$$\frac{\text{height of remaining cone}}{\text{height of actual cone}} = \frac{\text{radius of top surface of frustum}}{\text{radius of actual cone}}$$

$$\frac{4}{6} = \frac{r}{2}$$

$$r = \frac{4}{3} \text{ cm}$$

Volume of cake inside the cap = volume of frustum (formed)

$$= \frac{1}{3} \times \frac{22}{7} \times \left(2^2 + \left(\frac{4}{3} \right)^2 + (2) \left(\frac{4}{3} \right) \right) \times 2$$

$$= \frac{1}{3} \times \frac{22}{7} \times \frac{152}{9}$$

$$= \frac{2288}{189} \text{ cm}^3 \approx 17 \text{ cm}^3$$

So, Quantity I < Quantity II

S64. Ans.(a)

Sol.

Quantity I - Ratio of efficiency of Arun, Yash and Rana is 6 : 4 : 5

Total work done by them in 1 day = (6 + 4 + 5) units = (15) units.

Let them estimate x days to complete the work.

Then total work = 15x

But Rana's 1-day work is only 40%, i.e. $\frac{40}{100} \times 5 = 2$ unit

The work done by them in actual = (6 + 4 + 2) (x + 20) = 12(x + 20)

$$\therefore 15x = 12x + 240$$

$$3x = 240$$

$$x = 80$$

Hence estimated days are 80.

Quantity II - In the given figure

$$AB + CD = BC + AD$$

If a circle is circumscribed, then the trapezium is isosceles

$$\therefore AD = BC = 10$$

Hence,

$$DC = BC + AD - AB$$

$$\text{Or } DC = 10 + 10 - 8 = 12 \text{ cm}$$

$$500\% \text{ of } DC = 12 \times \frac{500}{100} = 60 \text{ cm}$$

So, **Quantity I > Quantity II**

S65. Ans.(b)

Sol.

$$\text{From(a)} \quad 12\% \text{ of } 9000 = \frac{RP}{100} + 180$$

$$RP = 90000 \quad \dots\dots\dots(1)$$

From(b)

$$X - (P + M) = 40Q + 400 \quad \dots\dots\dots(2)$$

$$Q + Y = 2(Z - 20) \quad \dots\dots\dots(3)$$

From(c)

$$\frac{XY}{100} = P \quad \dots\dots\dots(4)$$

$$P = 80Q + M \quad \dots\dots\dots(5)$$

From(d)

$$\frac{250}{100} \times M = \frac{P}{2}$$

$$P = 5M \quad \dots\dots\dots(6)$$

From(e)

$$80Q + \frac{XY}{100} = 10800$$

$$80Q + P = 10800 \quad \dots\dots\dots(7)$$

From(f)

$$2000 - S + \frac{15}{100}X = 3100 \quad \dots\dots\dots(8)$$

Using (6)

$$\text{Let } P = 5K \text{ so, } M = K$$

Using (5)

$$Q = \frac{4K}{80} = \frac{K}{20}$$

$$P : M : Q = 100 : 20 : 1$$

$$\text{Or } P : M : Q = 100a : 20a : a$$

Using (7)

$$80a + 100a = 10800$$

$$a = 60$$

$$\text{So, } P = 6000$$

$$M = 1200$$

$$Q = 60$$

Using (1)

$$R = 15$$

Using (2)

$$X - 7200 = 40 \times 60 + 400$$

$$X = 10000$$

Using (4)

$$Y = \frac{6000 \times 100}{10000} = 60$$

TEST SERIES
BILINGUAL



ESIC 2022
UDC
Prelims + Mains

50+ TOTAL TESTS



Using (8)

$$2000 - S + \frac{15}{100} \times 10000 = 3100$$

$$S = 400$$

From (3)

$$2Z = 180, Z = 80$$

Number of people suggest to immediate treatment from A in the years 2017

$$= 6000 \times \frac{15}{100} = 900$$

So, people found with disease but did not suggest to immediate treatment from A in 2017

$$= 6000 \times \frac{50}{100} - 900 = 2100$$

Number of people found with disease from A in 2018 = 1200

So, people found with disease but did not suggest to immediate treatment from A in 2018

$$= 1200 - 9000 \times \frac{12}{100} = 120$$

$$\text{Required difference} = 2100 - 120 = 1980$$

S66. Ans.(d)

Sol.

From(a) $12\% \text{ of } 9000 = \frac{RP}{100} + 180$

$$RP = 90000 \quad \dots\dots\dots(1)$$

From(b)

$$X - (P + M) = 40Q + 400 \quad \dots\dots\dots(2)$$

$$Q + Y = 2(Z - 20) \quad \dots\dots\dots(3)$$

From(c)

$$\frac{XY}{100} = P \quad \dots\dots\dots(4)$$

$$P = 80Q + M \quad \dots\dots\dots(5)$$

From(d)

$$\frac{250}{100} \times M = \frac{P}{2} \quad \dots\dots\dots(6)$$

$$P = 5M$$

From(e)

$$80Q + \frac{XY}{100} = 10800$$

$$80Q + P = 10800 \quad \dots\dots\dots(7)$$

From(f)

$$2000 - S + \frac{15}{100} X = 3100 \quad \dots\dots\dots(8)$$

Using (6)

Let $P = 5K$ so, $M = K$

Using (5)

$$Q = \frac{4K}{80} = \frac{K}{20}$$

$$P : M : Q = 100 : 20 : 1$$

$$\text{Or } P : M : Q = 100a : 20a : a$$

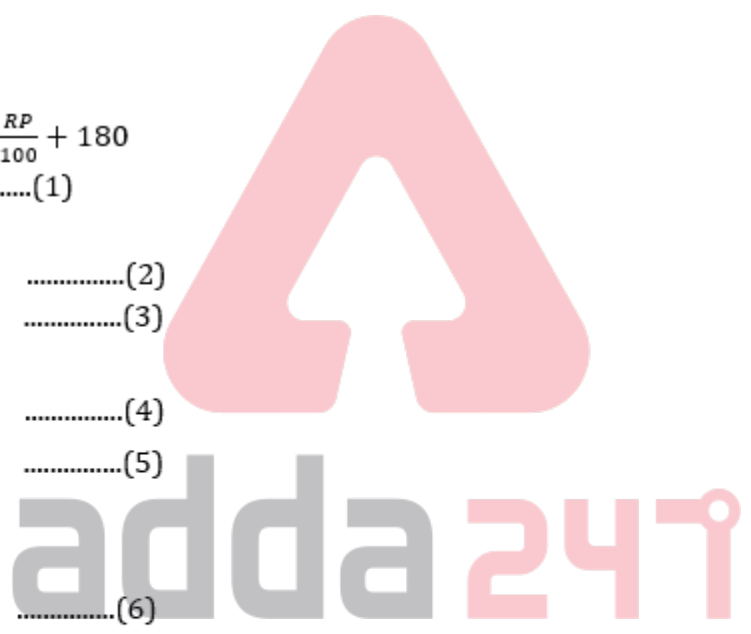

Using (7)

$$80a + 100a = 10800$$

$$a = 60$$

$$\text{So, } P = 6000$$

$$M = 1200$$

$$Q = 60$$

Using (1)

$$R = 15$$

Using (2)

$$X - 7200 = 40 \times 60 + 400$$

$$X = 10000$$

Using (4)

$$Y = \frac{6000 \times 100}{10000} = 60$$

Using (8)

$$2000 - S + \frac{15}{100} \times 10000 = 3100$$

$$S = 400$$

From (3)

$$2Z = 180, Z = 80$$

People found with disease but did not suggested to immediate treatment from village B in

$$2018 = 10000 \times \frac{25}{100} - 10000 \times \frac{10}{100} = 1500$$

Number of people donate blood from B in 2017

$$= 8000 \times \frac{60}{100} = 4800$$

$$\text{Required ratio} = \frac{1500}{4800} = 5 : 16$$

S67. Ans.(e)

Sol.

$$\text{From(a)} \quad 12\% \text{ of } 9000 = \frac{RP}{100} + 180$$

$$RP = 90000 \quad \dots\dots\dots(1)$$

From(b)

$$X - (P + M) = 40Q + 400 \quad \dots\dots\dots(2)$$

$$Q + Y = 2(Z - 20) \quad \dots\dots\dots(3)$$

From(c)

$$\frac{XY}{100} = P \quad \dots\dots\dots(4)$$

$$P = 80Q + M \quad \dots\dots\dots(5)$$

From(d)

$$\frac{250}{100} \times M = \frac{P}{2}$$

$$P = 5M \quad \dots\dots\dots(6)$$

From(e)

$$80Q + \frac{XY}{100} = 10800$$

$$80Q + P = 10800 \quad \dots\dots\dots(7)$$

From(f)

$$2000 - S + \frac{15}{100} X = 3100 \quad \dots\dots\dots(8)$$

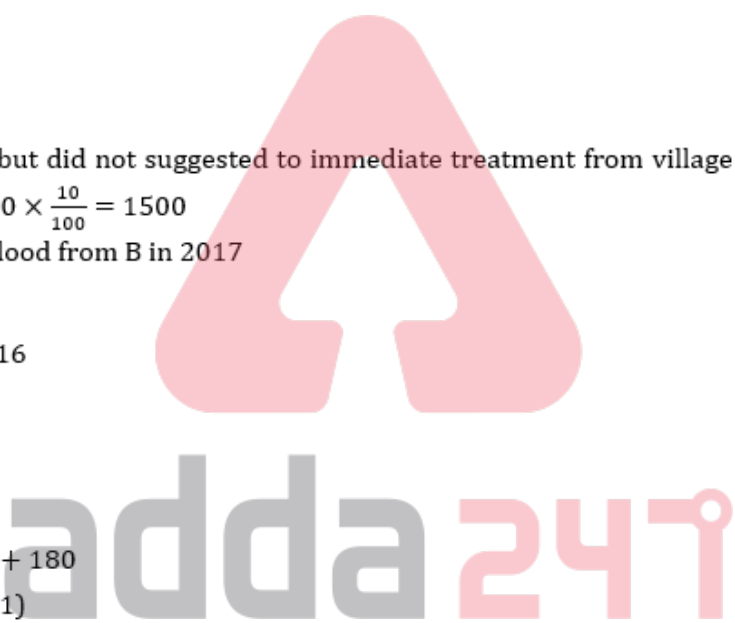

Using (6)

Let P = 5K so, M = K

Using (5)

$$Q = \frac{4K}{80} = \frac{K}{20}$$

$$P : M : Q = 100 : 20 : 1$$

$$\text{Or } P : M : Q = 100a : 20a : a$$

Using (7)

$$80a + 100a = 10800$$

$$a = 60$$

$$\text{So, } P = 6000$$

$$M = 1200$$

$$Q = 60$$

Using (1)

$$R = 15$$

Using (2)

$$X - 7200 = 40 \times 60 + 400$$

$$X = 10000$$

Using (4)

$$Y = \frac{6000 \times 100}{10000} = 60$$

Using (8)

$$2000 - S + \frac{15}{100} \times 10000 = 3100$$

$$S = 400$$

From (3)

$$2Z = 180, Z = 80$$

$$\text{Required difference} = 10000 - 6000 = 4000$$



S68. Ans.(c)

Sol.

From(a) $12\% \text{ of } 9000 = \frac{RP}{100} + 180$

$$RP = 90000 \quad \dots\dots\dots(1)$$

From(b)

$$X - (P + M) = 40Q + 400 \quad \dots\dots\dots(2)$$

$$Q + Y = 2(Z - 20) \quad \dots\dots\dots(3)$$

From(c)

$$\frac{XY}{100} = P \quad \dots\dots\dots(4)$$

$$P = 80Q + M \quad \dots\dots\dots(5)$$

From(d)

$$\frac{250}{100} \times M = \frac{P}{2}$$

$$P = 5M \quad \dots\dots\dots(6)$$

From(e)

$$80Q + \frac{XY}{100} = 10800$$

$$80Q + P = 10800 \quad \dots\dots\dots(7)$$

From(f)

$$2000 - S + \frac{15}{100}X = 3100 \quad \dots\dots\dots(8)$$

Using (6)

Let $P = 5K$ so, $M = K$

Using (5)

$$Q = \frac{4K}{80} = \frac{K}{20}$$

$$P : M : Q = 100 : 20 : 1$$

$$\text{Or } P : M : Q = 100a : 20a : a$$

Using (7)

$$80a + 100a = 10800$$

$$a = 60$$

$$\text{So, } P = 6000$$

$$M = 1200$$

$$Q = 60$$

Using (1)

$$R = 15$$

Using (2)

$$X - 7200 = 40 \times 60 + 400$$

$$X = 10000$$

Using (4)

$$Y = \frac{6000 \times 100}{10000} = 60$$

Using (8)

$$2000 - S + \frac{15}{100} \times 10000 = 3100$$

$$S = 400$$

From (3)

$$2Z = 180, Z = 80$$

$$\text{Total people registered for blood donation from B in 2019} = 10000 \times \frac{120}{100} \times \frac{75}{100} = 9000$$

Number of people registered for blood donation from A in 2017 & 2018

$$= 6000 \times \frac{75}{100} + 9000 \times \frac{80}{100}$$

$$= 11700$$

$$\text{Required difference} = 9000 - \frac{11700}{2} = 3150$$



S69. Ans.(d)

Sol.

Cities in which number of apple phones are less than the number of 1+ phones = (D, E & G)

$$\text{Population in city - D} = \frac{25000+40000}{0.260} \\ = 250000$$

$$\text{Population in city - E} = \frac{40000+50000}{0.400} \\ = 225000$$

$$\text{Population in city - G} = \frac{30000+60000}{0.225} \\ = 400000$$

$$\text{Required population} = 250000 + 225000 + 400000 \\ = 875000$$

S70. Ans.(c)

Sol.

ATQ,

City	Total Population	People without phone
A	150000	60000
B	250000	195000
C	200000	125000
D	250000	185000
E	225000	135000
F	300000	195000
G	400000	310000
H	350000	280000

In the table, people without phone are same for city - B & F and this is not possible as it is clearly mentioned in the question that the number of persons who do not own a phone is not same for any two cities. So, either in city - B or city - F at least 1 person is using more than 1 phone.

If in city - B at least 1 person is using more than 1 phone, then city - B has the 3rd highest number of people who do not own a phone and city - F has the 4th highest number of people who do not own a phone.

If in city - F at least 1 person is using more than 1 phone, then city - F has the 3rd highest number of people who do not own a phone and city - B has the 4th highest number of people who do not own a phone.

Hence, city - D has the 5th highest number of people who do not own a phone.

S71. Ans.(e)**Sol.**

ATQ,

City	Total Population	People without phone
A	150000	60000
B	250000	195000
C	200000	125000
D	250000	185000
E	225000	135000
F	300000	195000
G	400000	310000
H	350000	280000

In city - A, if only 1 person have all phone, then maximum number of persons who do not have a phone in city - A are 149999.

In city - B, if only 1 person have all phone, then maximum number of persons who do not have a phone in city - B are 249999.

In city - C, if only 1 person have all phone, then maximum number of persons who do not have a phone in city - C are 199999.

In city - D, if only 1 person have all phone, then maximum number of persons who do not have a phone in city - D are 249999.

In city - E, if only 1 person have all phone, then maximum number of persons who do not have a phone in city - E are 224999.

In city - F, if only 1 person have all phone, then maximum number of persons who do not have a phone in city - F are 299999.

In city - G, if at least 1 person have more than 1 phone, then minimum number of person who do not have a phone in city - G are 310001.

Hence, in city - F a person can have more than 1 phone.

S72. Ans.(c)**Sol.**

All 480 students selected at least one of these 3 subjects.

Let the no. of students who choose exactly one subject be S

Let the no. of students who choose exactly two subjects be D

Let the no. of students who choose exactly three subjects be T

$$S + D + T = 480$$

$$3D = S + T \text{ (given)}$$

$$\Rightarrow D = 120$$

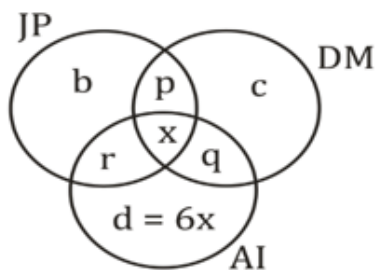

$$24 \leq p \leq 40 \text{ and } 40 \leq q \leq 56$$

We can write $p = (24+y)$ then $q = (40+y)$

Now, $r = 120 - (p + q)$

$$r = (56 - 2y)$$

ATQ

$$b + (24 + y) + (56 - 2y) + x = 6x + (56 - 2y) + (40 + y) + x - 4$$

$$b = (6x + 12)$$

Since x is at least 15, possible values of $b = 102, 108, 114, 120$

$$\text{Also, } c + b + d + x = 480 - 120 = 360$$

$$\Rightarrow c = (348 - 13x)$$

As, c is greater than b , possible values of $c = 153, 140, 127$ (x can take three values)

Hence, the possible values of $d = 90, 96 \text{ \& } 102$

x	b	c	d
15	102	153	90
16	108	140	96
17	114	127	102

Required possible difference = 63, 44 and 25

S73. Ans.(b)

Sol.

All 480 students selected at least one of these 3 subjects.

Let the no. of students who choose exactly one subject be S

Let the no. of students who choose exactly two subjects be D

Let the no. of students who choose exactly three subjects be T

$$S + D + T = 480$$

$$3D = S + T \text{ (given)}$$

$$\Rightarrow D = 120$$

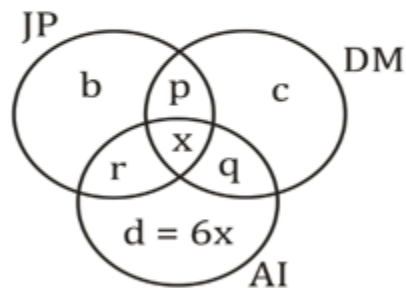

$$24 \leq p \leq 40 \text{ and } 40 \leq q \leq 56$$

We can write $p = (24+y)$ then $q = (40+y)$

Now, $r = 120 - (p + q)$

$$r = (56 - 2y)$$

ATQ

$$b + (24 + y) + (56 - 2y) + x = 6x + (56 - 2y) + (40 + y) + x - 4$$

$$b = (6x + 12)$$

Since x is at least 15, possible values of b = 102, 108, 114, 120

$$\text{Also, } c + b + d + x = 480 - 120 = 360$$

$$\Rightarrow c = (348 - 13x)$$

As, c is greater than b, possible values of c = 153, 140, 127 (x can take three values)

Hence, the possible values of d = 90, 96 & 102

x	b	c	d
15	102	153	90
16	108	140	96
17	114	127	102

Quantity I: Possible difference = 51, 32 and 13

Maximum possible difference = 51

Quantity II: 60

Quantity II > Quantity I

S74. Ans.(a)

Sol.

All 480 students selected at least one of these 3 subjects.

Let the no. of students who choose exactly one subject be S

Let the no. of students who choose exactly two subjects be D

Let the no. of students who choose exactly three subjects be T

$$S + D + T = 480$$

$$3D = S + T \text{ (given)}$$

$$\Rightarrow D = 120$$

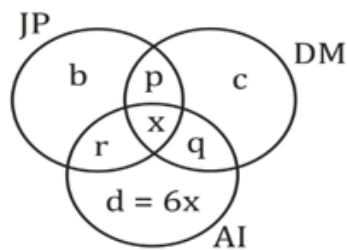

$$24 \leq p \leq 40 \text{ and } 40 \leq q \leq 56$$

We can write $p = (24 + y)$ then $q = (40 + y)$

$$\text{Now, } r = 120 - (p + q)$$

$$r = (56 - 2y)$$

ATQ

$$b + (24 + y) + (56 - 2y) + x = 6x + (56 - 2y) + (40 + y) + x - 4$$

$$b = (6x + 12)$$

Since x is at least 15, possible values of b = 102, 108, 114, 120

$$\text{Also, } c + b + d + x = 480 - 120 = 360$$

$$\Rightarrow c = (348 - 13x)$$

As, c is greater than b, possible values of c = 153, 140, 127 (x can take three values)

Hence, the possible values of $d = 90, 96 \& 102$

x	b	c	c
15	102	153	90
16	108	140	96
17	114	127	102

All possible value of number of students who choose exactly one subjects = 345, 344 and 343

So, required average = 344

S75. Ans.(d)

Sol.

All 480 students selected at least one of these 3 subjects.

Let the no. of students who choose exactly one subject be S

Let the no. of students who choose exactly two subjects be D

Let the no. of students who choose exactly three subjects be T

$$S + D + T = 480$$

$$3D = S + T \text{ (given)}$$

$$\Rightarrow D = 120$$

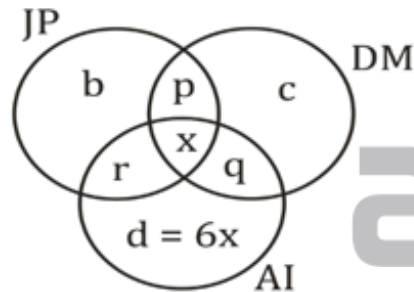

$$24 \leq p \leq 40 \text{ and } 40 \leq q \leq 56$$

We can write $p = (24 + y)$ then $q = (40 + y)$

$$\text{Now, } r = 120 - (p + q)$$

$$r = (56 - 2y)$$

ATQ

$$b + (24 + y) + (56 - 2y) + x = 6x + (56 - 2y) + (40 + y) + x - 4$$

$$b = (6x + 12)$$

Since x is at least 15, possible values of $b = 102, 108, 114, 120$

$$\text{Also, } c + b + d + x = 480 - 120 = 360$$

$$\Rightarrow c = (348 - 13x)$$

As, c is greater than b, possible values of $c = 153, 140, 127$ (x can take three values)

Hence, the possible values of $d = 90, 96 \text{ \& } 102$

x	b	c	c
15	102	153	90
16	108	140	96
17	114	127	102

We have to minimize $(q + r) = (56 - 2y) + (40 + y) = 96 - y$
 When y is max i.e., 16, we will get the min. value = 80

S76. Ans.(e)

Sol. No. of students who choose JP = $b + p + r + x = (92 - y + 7x)$
 The above quantity will be maximum when y is minimum & x is max. i.e. 17
 So, max students who choose JP = 211

S77. Ans.(b)

Sol.

let total students in B = $3x^\circ$

So, total students in D = $3x^\circ \times \left(1 + \frac{4}{3}\right) = 7x^\circ$ respectively

Total students in C = $(360^\circ - 108^\circ) - 10x^\circ = 252^\circ - 10x^\circ$

Given, Total students in C > total students in B

So, $252^\circ - 10x^\circ > 3x^\circ$ ----- (i)

By the options

Only at 54° , above equations satisfies

So, B (total students) = 54°

C (total students) = 72°

D (total students) = 126°

S78. Ans.(e)

Sol.

Information from the above question total students from B = 54°

Given, Total students in B = $54^\circ = 5400$

Total students passed from B = $\frac{98}{100} \times 5400 = 5292$

And, total students in D = $126^\circ = 5400 \times \frac{126^\circ}{54^\circ} = 12600$

Since total passed students from D can either be 240 more or less than that of from B

So, total passed students from D **either** = $240 + 5292 = 5532$

Or, total passed students from D = $5292 - 240 = 5052$

Total failed students from D **either** = $12600 - 5532 = 7068$

Or, total failed students from D = $12600 - 5052 = 7548$

Total students in all four = $360^\circ = 36000$

Total failed students = 20% of total students in these four schools = $36000 \times \frac{20}{100} = 7200$

Since failed students from D should be less than total failed students

And, failed students from D Should be = 7068

So, passed students from D should be = 5532

Required difference = $7068 - 5532 = 1536$

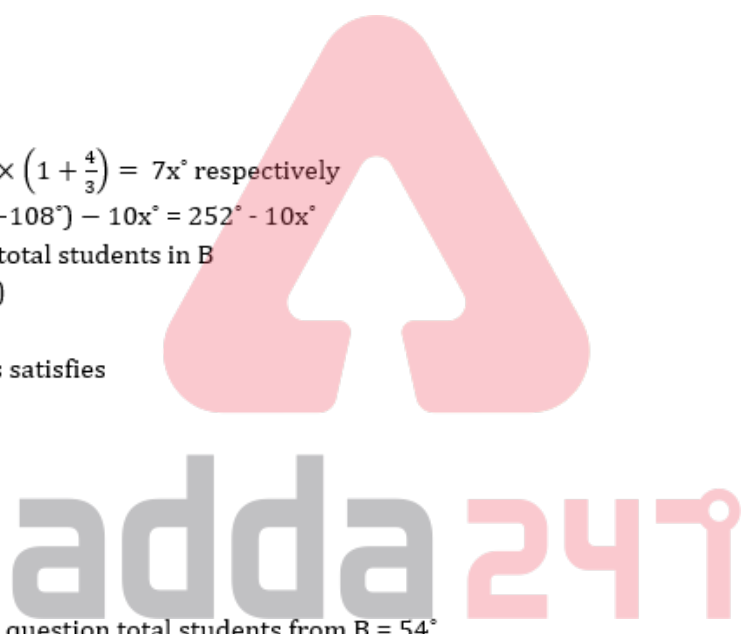

S79. Ans.(e)

Sol.

Information from the above question total students from C = 72°

Central angle corresponding to passed students from C should be \leq central angle corresponding to total students from C

Only satisfying values from options either 54° or 60°

S80. Ans.(c)

Sol.

let passed students from A be x

Given, total passed students from D more than that of from B

So, total passed students from D = 240 + 1800 = 2040

$x + 2040 = 5400$

$x = 3360$

Total passed students from C = $\frac{4}{3} \times (3360 - 1800) = 2080$

S81. Ans.(a)

Sol. Any business that sells or serves alcoholic beverages, including restaurants, nightclubs, and bars, can be held liable for damages or injuries caused by intoxicated patrons.

S82. Ans.(d)

Sol. Cheque Truncation System (CTS) is a cheque clearing system undertaken by the Reserve Bank of India (RBI) for faster clearing of cheques.

S83. Ans.(e)

Sol. India will co-host 2031 50-over WC & 2026 ICC T20 WC2029 and host ICC Men's Champions Trophy
The International Cricket Council (ICC) has announced the 14 host countries of the ICC men's white-ball events from 2024-2031.

India is set to host the 2029 Champions Trophy and co-host the 2026 ICC Men's Twenty20 World Cup with Sri Lanka and 2031 ICC Men's 50-over World Cup with Bangladesh.

The hosts were selected through a competitive bidding process overseen by an ICC Hosting Sub-Committee chaired by Martin Snedden along with Sourav Ganguly, President of Board of Control for Cricket in India and Ricky Skerritt, President of Cricket West Indies.

S84. Ans.(d)

Sol. Ombudsman's powers are restricted to insurance contracts of value not exceeding Rs. 20 lakhs.

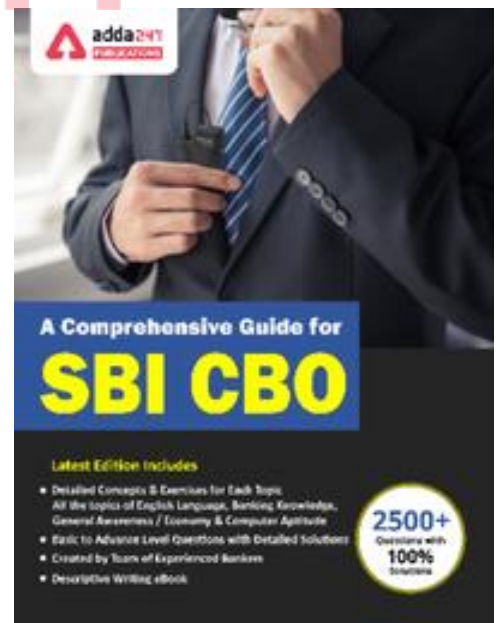

S85. Ans.(c)

Sol. The Meenakshi Amman temple is a historic Hindu temple located on the southern bank of the Vaigai River in the temple city of Madurai, Tamil Nadu.

S86. Ans.(c)

Sol. AePS is a bank led model which allows online interoperable financial inclusion transaction at PoS (MicroATM) through the Business correspondent of any bank using the Aadhaar authentication. AePS allows you to do six types of transactions.

S87. Ans.(c)

Sol. Integral part of a speculative decision where only three alternatives are possible: gain, loss, or break even. Dynamic risks are not insurable.

S88. Ans.(c)

Sol. SEBI formed 4-Member Advisory Committee on Settlement Orders Chaired by Vijay C Daga In October 2021, the Securities and Exchange Board of India (SEBI) constituted a 4-member advisory committee on settlement orders and compounding of offences.

The advisory committee will be chaired by Vijay C Daga, retired judge of the High Court of Bombay.

The committee will work as per the SEBI (Settlement Proceedings) Regulations, 2018.

As the entities are currently provided with a window of 180 days to apply for settlement after receipt of the show-cause notice, the applicants mostly apply for settlement at the end of that 180 days.

To overcome such delays, the time limit for filing settlement applications was recommended to be reduced from 180 to 60 days.

S89. Ans.(b)

Sol. TransUnion CIBIL Limited (formerly Credit Information Bureau (India) Limited) was incorporated based on recommendations made by the RBI Siddiqui Committee.

S90. Ans.(c)

Sol. A mutual insurance company is an insurance company owned entirely by its policyholders. Any profits earned by a mutual insurance company are rebated to policyholders in the form of dividend distributions or reduced future premiums.

S91. Ans.(c)

S92. Ans.(e)

Sol. WHO Global TB report for 2021: India worst-hit country in TB elimination

On 14th October 2021, the World Health Organisation (WHO) released the 'Global TB report for 2021, where it highlighted the effects of COVID-19 which led to a huge reversal in the progress of Tuberculosis (TB) elimination. The report also mentioned India as the worst-hit country in TB elimination, where the detection of new TB cases saw a huge impact in 2020.

A dramatic reduction of 20% TB cases were witnessed in 2020 as compared to 2019, ie; a gap of 4.1 million cases.

The progress in TB detection has gone back to the levels of 2012, with India accounting for 41% of the total case drops in 2020.

S93. Ans.(d)

Sol. A period where a new insurance policy owner is able to terminate the contract without penalties such as surrender charges is termed as Free Lock Period.

S94. Ans.(a)

Sol. India, Singapore, Thailand conducted Trilateral Maritime Exercise SITMEX 21

India, Singapore, and Thailand participated in 3rd edition of Trilateral Maritime Exercise named as 'SITMEX - 21', which was held from 15 to 16 November 2021 in the Andaman Sea.

From India, Indian Naval Ship Karmuk is participating, which is an indigenously built Missile Corvette. It is being hosted by Royal Thai Navy (RTN) to enhance the cooperation between the participating navies towards augmenting the overall maritime security.

S95. Ans.(e)

Sol. Life Insurance Corporation of India is an Indian state-owned insurance group and investment company headquartered in Mumbai. It is the largest insurance company in India.

S96. Ans.(d)

Sol. GAP insurance is the difference between the actual cash value of a vehicle and the balance still owed on the financing (car loan, lease). GAP coverage is mainly used on new and used small vehicles (cars and trucks) and heavy trucks.

S97. Ans.(b)

Sol. Paytm Money launched AI-powered 'Voice Trading'

Paytm Money, the wholly-owned subsidiary of Paytm, has launched 'Voice Trading', powered by artificial intelligence (AI). It will allow users to place a trade or get information about stocks via single voice command.

This voice command feature uses neural networks and natural language processing (NLP) to allow instant processing. This service has been launched in line with Paytm Money's efforts to offer next-gen and AI-driven tech to elevate user experience.

S98. Ans.(e)

Sol. Pradhan Mantri Suraksha Bima Yojana (PMSBY) is available to people in the age group 18 to 70 years with a bank account who give their consent to join/ enable auto-debit on or before 31st May for the coverage period 1st June to 31st May on an annual renewal basis. Aadhar would be the primary KYC for the bank account. The risk coverage under the scheme is Rs. 2 lakh for accidental death and full disability and Rs. 1 lakh for partial disability.

S99. Ans.(c)

Sol. Institutional investor is a term for entities which pool money to purchase securities, real property, and other investment assets or originate loans. Institutional investors include banks, insurance companies, pensions, hedge funds, investment advisors, endowments, and mutual funds.

S100. Ans.(d)

Sol. SIDBI launched 2nd window of Swavalamban Challenge Fund (SCF)

Small Industries Development Bank of India (SIDBI) launched the second window of Swavalamban Challenge Fund (SCF) which aims to provide financial support to non-profit organizations, educational institutions for addressing developmental gaps.

This edition themes are aligned with attaining net zero emissions by 2070, as per the commitments made by India at 26th UN (United Nations) Climate Change Conference of the Parties (COP 26). Therefore, 'Green Bharat' is the prioritised theme for the same.

This fund is a part of Swavalamban Resource Facility (SRF) being implemented by SIDBI in partnership with Foreign, Commonwealth and Development Office (FCDO), United Kingdom (UK). The first window of SCF was launched in August 2021 to promote entrepreneurship culture in India. SIDBI is the sole facilitator for SCF.

S101. Ans.(c)

Sol. APY was launched on 9th May 2015 by the Prime Minister. APY is open to all saving bank/post office saving bank account holders in the age group of 18 to 40 years and the contributions differ, based on pension amount chosen. Subscribers would receive the guaranteed minimum monthly pension of Rs. 1,000 or Rs. 2,000 or Rs. 3,000 or Rs. 4,000 or Rs. 5,000 at the age of 60 years.

S102. Ans.(d)

Sol. Kotak Mahindra Bank has launched a platform named 'Neo Collections', which is a Do It Yourself Digital Repayment Platform for missed loan repayments.

S103. Ans.(b)

Sol. Mirzapur Season 2 has won the "Best Series" Award at the Indian Film Festival of Melbourne (IFFM) 2021.

S104. Ans.(d)

Sol. Apple is the world's most valuable company (USD 2,443 billion) according to the Hurun Global 500 Most Valuable Companies list 2021.

S105. Ans.(e)

Sol. Facebook India has launched "Small Business Loans Initiative" in India in partnership with online lending platform Indifi. India is the first country where Facebook is rolling out this programme.

S106. Ans.(d)

Sol. Private sector, Public sector and State government can set up Special Economic Zones (SEZs)

S107. Ans.(b)

Sol. Securitisation and Reconstruction of Financial Assets and Enforcement of Security Interest Act 2002 is popularly known as Securitisation Act. This act enables the banks to issue notices to defaulters who have to pay the debts within 60 days. Once the notice is issued the borrower cannot sell or dispose the assets without the consent of the lender. The Securitisation Act further empowers the banks to take over the possession of the assets and management of the company. The lenders can recover the dues by selling the assets or changing the management of the firm. The Act also enables the establishment of Asset Reconstruction Companies for acquiring NPA.

S108. Ans.(b)

Sol. Airtel Payments Bank has launched “DigiGold”, a digital platform for customers to make investments in gold. This has been rolled out in partnership with SafeGold, a provider of digital gold.

With DigiGold, Airtel Payments Bank’s saving account customers can invest in 24K gold using the Airtel Thanks app. Customers can also gift DigiGold to their family and friends, who have a savings account with Airtel Payments Bank.

S109. Ans.(d)**Sol. S110. Ans.(d)**

Sol. Lok Sabha has passed the Surrogacy (Regulation) Bill, 2016 which is aimed at prohibiting commercial surrogacy and unethical practices relating to it. The Bill has provisions to constitute National Surrogacy Board, State Surrogacy Boards, and appointment of appropriate authorities for regulation of surrogacy.

S111. Ans.(c)

Sol. The full form of OTP in credit and debit card transactions is One Time Password.

S112. Ans.(a)

Sol. •First Plastic Currency issued by bank were Automated Teller Machine (ATM) cards which was issued by Barclays, London in 1967 and by Chemical Bank, New York in 1969.

•Prior to this, in 1950’s Diners Club and American Express introduced charge cards in USA. It was the first plastic currency but was not official as it was not issued by any bank

S113. Ans.(e)

Sol. The European Bank for Reconstruction and Development is an international financial institution founded in 1991. As a multilateral developmental investment bank, the EBRD uses investment as a tool to build market economies. The Head Office of EBRD is in London, UK.

S114. Ans.(b)

Sol. Sourav Ganguly appointed as the chairman of ICC Men’s Cricket Committee

The President of BCCI, Sourav Ganguly has been appointed as the Chairman of the ICC men's Cricket Committee, the global cricket governing body. He replaced Anil Kumble who assumed the charge in 2012. Kumble stepped down having served a maximum of three separate three-year terms.

Sourav Ganguly was appointed as the president Board of Control for Cricket in India (BCCI) in October 2019. Johnny Grave, CEO of Cricket West Indies has been appointed to the ICC Women's Cricket Committee.

S115. Ans.(e)

Sol. Salient Features of NFS are given below:-

1. NFS has introduced sub-membership model which enables smaller, regional banks including RRBs and local co-operative banks to participate in the ATM network.
2. NFS has maintained high standards of application and network uptime of above 99.50% which has helped our member banks ensure enhanced customer experience.
3. The Dispute Management System (DMS), has benefitted members with high operational efficiency and ease of online transaction life cycle management (chargeback, representment, etc.) in the network apart from being compliant with local regulatory requirements.

4. NPCI has also tied up with International card schemes like Discover Financial Service (DFS), Japan Credit Bureau (JCB) and China UnionPay International (CUPI) which allows their cardholders to use ATMs connected to NFS network.

5. The Fraud Risk Management (FRM) solution is offered as a value added service to monitor transactions (in real time) and to generate alert or decline the transaction in the NFS network.

S116. Ans.(d)

Sol. India's first cryptogamic garden, with around 50 different species grown, has been inaugurated in Deoban area of Dehradun in Uttarakhand.

The garden is situated at a height of 9,000 feet and is spread over an area of three acres. Located in the district's Chakrata town, the garden was inaugurated by social activist Anoop Nautiyal.

S117. Ans.(c)

Sol. United Nations has declared July 12, which is Malala Yousafzai's birthday, as Malala Day in honour of the young activist. She won the Nobel Peace Prize in 2014. The-then 17-year-old became the youngest recipient of the award.

A book will document the journeys of 25 exceptionally brave girls who fought oppression and defied regressive social norms for their right to education, the publishers announced ahead of Malala Day.

S118. Ans.(c)

Sol. Nongkram Dance is the religious dance festival in Meghalaya, and is mainly celebrated with tremendous zeal and fervor by the inhabitants of the Khasi Hills.

S119. Ans.(b)

Sol. World Toilet Day (WTD) is an official United Nations international observance day on 19 November to inspire action to tackle the global sanitation crisis.

S120. Ans.(d)

Sol. Mongolia Capital- Ulaanbaatar, Currency- Mongolian togrog.

S121. Ans.(d)

Sol. To validate the answer, refer to the second paragraph of the passage given above, which mentions, "Companies need to develop these capabilities to respond quickly and effectively to emerging threats to their businesses, and to seize new market opportunities. Moreover, while these capabilities can be understood as discrete, they actually form a complex, interacting foundation for the whole enterprise." Here, the quoted text has been mentioned in both the statements (b) and (c). hence, option (d) is the most suitable answer choice.

S122. Ans.(b)

Sol. to validate the answer, refer to the third paragraph of the passage given above, which mentions, "Informed decision making is a company's ability to make the best possible decision in a given situation. To do this, active decisions must be based on real data, rather than past experiences and shared throughout the organization." Here, we can infer the quoted text from the statement given in option (b). Hence, option (b) is the most suitable answer choice.



BILINGUAL

ESIC 2022
UDC & MTS
New Prelims Batch

Starts Jan 10, 2022 | 12 PM to 4 PM

S123. Ans.(d)

Sol. to validate the answer, refer to the last few lines of the second paragraph, which mentions, “*Such insights can be captured not only internally from employees, for example, or the organization’s internal operating environment, but they can also be obtained from external sources, such as customers, partners and competitors.*” Here, we can infer the quoted text from the statement given in option (d). Hence, option (d) is the most suitable answer choice.

S124. Ans.(c)

Sol. to validate the answer, refer to the first paragraph of the passage given above, which mentions, “*In fact, a great way for incumbents to fight against digital disruptors and to generate new value for customers is to focus on managing their workforce better.*” Here, we can infer the quoted text from the statement given in option (c). Hence, option (c) is the most suitable answer choice.

S125. Ans.(e)

Sol. all the given words are synonymous with ‘correspond’. Hence, option (e) is the most suitable answer choice.

Correspond: have a close similarity; match or agree almost exactly.

S126. Ans.(d)

Sol. Among the given words, only ‘acclimatize’ is similar in meaning with ‘attuned’. Hence, option (d) is the most suitable answer choice.

Attuned: accustom or acclimatize

Stipulation: a condition or requirement that is specified or demanded as part of an agreement.

Indurate: harden.

Congel: become semi-solid, especially on cooling.

S127. Ans.(a)

Sol. To validate the answer, refer to the 4th paragraph of the passage given above, which mentions, “*However, a company fails only if it does not learn something from a negative experience.*”

S128. Ans.(c)

Sol. In the statement given above, there is an error of parallelism where ‘identification’ will be replaced with ‘identify’. Hence, option (c) is the most suitable answer choice.

S129. Ans.(d)

Sol. To validate the answer, refer to the third paragraph of the passage given above, which mentions, “*The IMF’s difficulty in saying no to Argentina partly reflects an acrimonious history stemming from the failed loans from the late 1990s through 2001. It was also hard for the Fund to resist funding a big program in a world where countries can borrow at ultra-low interest rates from private markets.*” Among the given statements, we can infer the quoted text from the statement given in option (d). Hence, option (d) is the most suitable answer choice.

S130. Ans.(c)

Sol. To validate the answer, refer to the first paragraph of the passage given above, which mentions, “*But in both cases, default was inevitable, because the country’s mix of debt, deficits, and monetary policy was unsustainable, and the political class was unable to make the necessary adjustments in time.*” Among the given statements, only the statement given in option (c) justifies the quoted text. Hence, option (c) is the most suitable answer choice.

S131. Ans.(d)

Sol. among the given statements, the phrase “bare coffers” has been correctly used in statements (ii) and (iii). Hence, option (d) is the most suitable answer choice.

Coffers, as per the statement given in the passage, have been used to define the funds or financial reserves of an organization. Whereas, in the first statement, ‘coffer’ has been used to denote ‘a *strongbox or small chest for holding valuables.*’

S132. Ans.(c)

Sol. To validate the answer, refer to the last paragraph of the passage given above, which mentions, “*Political support for necessary loan conditionality has been eroded by repeated attacks from the left, which does not accept that the IMF does not have scope to give outright grants.*” Among the given statements, we can infer the quoted text from the statement given in option (c). Hence, option (c) is the most suitable answer choice.

S133. Ans.(d)

Sol. To validate the answer, refer to the last line of the second paragraph, which mentions, “*The only answer is to increase substantially the resources of international aid agencies (the IMF is a lender).*” From the quoted text, we can infer that the statement given in statement (d) is incorrect as per the information given in the passage. Hence, option (d) is the most suitable answer choice.

S134. Ans.(d)

Sol. The slippery slope involves an acceptance of a succession of events without direct evidence that this course of events will happen. Among the given statements, only the statement given in option (d) could justify the correct meaning of the phrase. Hence, option (d) is the most suitable answer choice.

S135. Ans.(b)

Sol. In the given statement, the error lies in part (b) of the statement where, ‘then’ will be replaced with ‘than’, owing to the comparison being made in the statement. Hence, option (b) is the most suitable answer choice.

S136. Ans.(b)

Sol. Reading the sentence we can see that the sentence is discussing about government’s efforts in favour of someone/ something. So, the sentence will begin from [4]. Following [4] will be [1] which adds meaning to [4] as [1] explains what ‘they’ were used for. Then [2] will be the next phrase as [1] and [2] both give examples. Following [2] is [3]. Thus 4123 will be arrangement. Hence, option (b) will be the correct answer choice.

S137. Ans.(a)

Sol. The beginning phrase will be [1] as none other phrase can be used. [1] discusses about a trio who has redeveloped some kind of field which is mentioned in the [4], so [4] will follow [1]. Then [3] will follow [4] as it explains how the trio redeveloped i.e. by the use of new technology which is mentioned in the [3]. Last phrase will be [2]. Hence, the correct arrangement sequence will be 1432. Thus, the correct option is (a).

S138. Ans.(d)

Sol. [3] will be the first phrase which gives the introduction of a person. The following phrase will be [1] as it adds meaning to [3]. Then, out of [2] and [4], [2] will follow [1] as choosing [2] be the last phrase will make the sentence incomplete. Hence the arrangement will be 3124. Hence, the correct answer choice will be (d).

S139. Ans.(b)

Sol. [1], [2] and [3]; all can be the beginning phrase, but from the given phrases choosing [1] and [2] will the sentence structure absurd. So, [3] will be the beginning phrase. Following [3] will be [1] which then be followed by [4]. Thus, the sentence arrangement will be 3142. Hence, the correct answer choice be (b).

S140. Ans.(d)

Sol. From the given phrases [3] will be the beginning phrase because all other phrases have connectors as the first word. [3] explains about three economists. [3] will be followed by [1] as it gives the name of first two economist. Then [2] will be the next phrase as [2] gives the name of the third economists. Thus, the rearrangement will be 3124. Hence, the correct answer choice will be (d).

S141. Ans.(c)

Sol. The rearranged sentences when read explain about three economists have been awarded Noble. These economists are mentioned in (E). But it can't be the first statement as talks about change of some 'status quo'. When read, we can infer that (E) is talking about the change in the position of poor which are mentioned in (C). So, (C) will be the first statement. Following (C) will be (A) as it explains the example of the statement mentioned in (C). Out of (E) and (C), (E) will be the next statement as it names the economists who are then mentioned in (D). (B) fails to become part of the rearrangement as it discusses about some economists, but we are not given the name of that economist. Thus, rearrangement will be CAED. Hence, the correct answer choice is (c).

S142. Ans.(d)

Sol. The given sentence discusses about the problem of slowdown in the economy. So, from the given options (C) would go in the blank [I]. As for [II], 'mandarins' which is used as a synonym for official, will fit.

Irrascible: having or showing a tendency to be easily angered.

Monologue: a long, tedious speech by one person during a conversation.

Malaise: a general feeling of discomfort, illness, or unease whose exact cause is difficult to identify.

Loquacious: tending to talk a great deal; talkative.

Consternations: a feeling of anxiety or dismay, typically at something unexpected.

Hence, option (d) is correct answer choice.

S143. Ans.(e)

Sol. For the blank [I], 'moribund' would be contextually incorrect and 'vitriolic' does not fit in as per the theme of the sentence. For [II] 'contagion' will fit.

Vigour: effort, energy, and enthusiasm.

Vitriolic: filled with bitter criticism or malice.

Moribund: (of a thing) in terminal decline; lacking vitality or vigour.

Azure: a bright blue colour.

Contagion: the spreading of a harmful idea or practice.

Askance: with an attitude or look of suspicion or disapproval.

Hence, the correct answer choice is (e).

S144. Ans.(a)

Sol. The sentence is discussing about either increase or decrease in the growth. But the two factors given in the end of the sentence proves that the growth is decreasing. Thus, option (B) fits in blank [I]. (E) will fit both grammatically and contextually in [II].

Interminable: endless or apparently endless (often used hyperbolically).

Unobtrusive: not conspicuous or attracting attention.

Perpetual: never ending or changing.

Despondent: in low spirits from loss of hope or courage.

Elevated: (of a level or amount) higher or greater than normal.

Lurid: unpleasantly bright in colour, especially so as to create a harsh or unnatural effect.

Hence, correct answer choice is (a).

S145. Ans.(c)

Sol. Idiosyncratic: relating to idiosyncrasy; peculiar or individual.

Indigent: poor; needy.

Solicitous: characterized by or showing interest or concern.

Insouciance: casual lack of concern; indifference.

Mendacious: not telling the truth; lying.

Tenacious: tending to keep a firm hold of something; clinging or adhering closely.

Hence, the correct answer choice is option (c).

S146. Ans.(e)

Sol. 'On thin ice' means in a precarious or risky situation.

So, from the given sentences, only the highlighted phrase of the sentence (i) and (iii) can be replaced without changing their meaning. Hence, the correct answer choice would be option (e).

S147. Ans.(b)

Sol. Once in a blue moon means very rarely.

So, from the given sentences, only the phrase of the sentence (ii) can be replaced without changing its intended meaning. Hence, the correct answer choice would be option (b).

S148. Ans.(b)

Sol. 'Under the weather' means slightly unwell or in low spirits.

So, from the given sentences, only the phrase of sentence (ii) can be replaced without changing its meaning. Hence, the correct answer choice would be option (b).

S149. Ans.(c)

Sol. If you change your tune, you change the way you behave with others from bad to good

So, from the given sentences, only the phrases of sentence (iii) can be replaced without changing its meaning. Hence, the correct answer choice would be option (c).

S150. Ans.(a)

Sol. 'Blow hot and cold' means alternate or waver between different opinions or actions; be indecisive.

So, from the given sentences, only the phrases of sentence (i) can be replaced without changing its meaning. Hence, the correct answer choice would be option (a).

S151. Ans.(e)

Sol. In the given sentence, the error lies in part (C) of the given sentence. The use of 'lies' here is incorrect instead it should be 'lie' because as per the rule we use "s/es" with third person singular. Hence, the correct answer choice would be option (e)

S152. Ans.(d)

Sol. In the given statement, the error lies in part (E). The use of "it's" here is incorrect instead it should be "its" because "Its" is a possessive form of it, meaning belonging to it whereas "It's" is a contraction of the words it is or it has. Hence, the correct answer choice would be option (d).

S153. Ans.(d)

Sol. The error lies in part (E) of the given sentence. The use of past tense (had) here is incorrect instead it should be in present tense (have) because taking hint from the starting of the sentence 'The recent' it can be clearly seen that the given sentence should be in present tense. Hence, the correct answer choice would be option (d).

S154. Ans.(a)

Sol. The error lies in part (D) of the given sentence. The use of 'being' here is incorrect instead it should be 'be' because 'will' being a modal verb is followed by base form of the verb. Hence, the correct answer choice would be option (a)

S155. Ans.(e)

Sol. In the given statement the error lies in part (C) of the sentence. The use of 'of' here is incorrect instead it should be 'at' because preposition 'of' is used for belonging to, relating to, or connected with. Hence, the correct answer choice would be option (e).

