

All India Mock IBPS RRB Clerk Prelims 2022 on 30th-31st July – PDF (Solutions)

S1. Ans.(a)

Sol. From the given statements, J lives to the west of M. There are two floors gap between D and J who does not live on bottom most floor. So, we have two possible cases- Case 1 and Case 2.

Floors	Case-1		Case-2	
	Flat-1	Flat-2	Flat-1	Flat-2
4	J	M	J	M
3				
2				
1	D			D

Q lives in the south-west of K but not above L's floor. Here Case 1 is ruled out now. H lives in the east of L but not live on odd numbered floor. So, the final arrangement is -

Floors	Flat-1	Flat-2
4	J	M
3	S	K
2	L	H
1	Q	D

S2. Ans.(c)

Sol. From the given statements, J lives to the west of M. There are two floors gap between D and J who does not live on bottom most floor. So, we have two possible cases- Case 1 and Case 2.

Floors	Case-1		Case-2	
	Flat-1	Flat-2	Flat-1	Flat-2
4	J	M	J	M
3				
2				
1	D			D

Q lives in the south-west of K but not above L's floor. Here Case 1 is ruled out now. H lives in the east of L but not live on odd numbered floor. So, the final arrangement is -

Floors	Flat-1	Flat-2
4	J	M
3	S	K
2	L	H
1	Q	D

TEST SERIES

BILINGUAL

VIDEO SOLUTIONS



IBPS PO 2022

PRELIMS + MAINS

90+ Total Tests | eBooks

S3. Ans.(b)

Sol. From the given statements, J lives to the west of M. There are two floors gap between D and J who does not live on bottom most floor. So, we have two possible cases- Case 1 and Case 2.

Floors	Case-1		Case-2	
	Flat-1	Flat-2	Flat-1	Flat-2
4	J	M	J	M
3				
2				
1	D			D

Q lives in the south-west of K but not above L's floor. Here Case 1 is ruled out now. H lives in the east of L but not live on odd numbered floor. So, the final arrangement is -

Floors	Flat-1	Flat-2
4	J	M
3	S	K
2	L	H
1	Q	D

S4. Ans.(d)

Sol. From the given statements, J lives to the west of M. There are two floors gap between D and J who does not live on bottom most floor. So, we have two possible cases- Case 1 and Case 2.

Floors	Case-1		Case-2	
	Flat-1	Flat-2	Flat-1	Flat-2
4	J	M	J	M
3				
2				
1	D			D

Q lives in the south-west of K but not above L's floor. Here Case 1 is ruled out now. H lives in the east of L but not live on odd numbered floor. So, the final arrangement is -

Floors	Flat-1	Flat-2
4	J	M
3	S	K
2	L	H
1	Q	D

S5. Ans.(c)

Sol. I. $Y \leq H$ (False) **II.** $Y > H$ (False)

S6. Ans.(b)

Sol. I. $M > D$ (False) **II.** $Z < I$ (True)

S7. Ans.(b)

Sol.

4 7 2 8 4 6 8 4 7 2
 8 8 7 7 6 4 4 4 2 2

S8. Ans.(d)

Sol. From the given statements, B sits immediate to the right of C. One person sits between B and E. Here we get 4 possibilities i.e., Case 1, Case 2, Case 3 and Case 4.

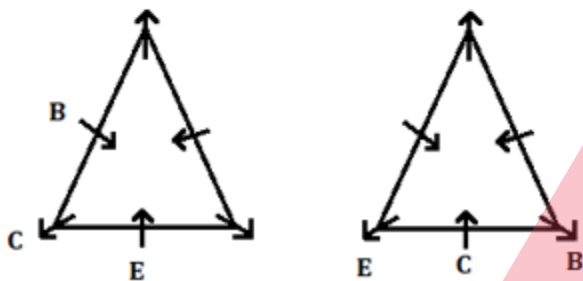
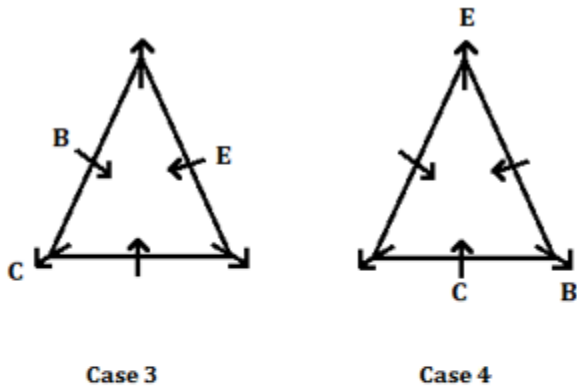

Two persons sit between A and D. From this condition Case 3 and Case 4 are eliminated.

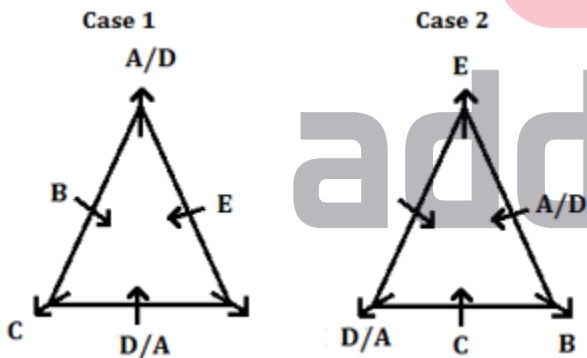

Both A and F are not sitting adjacent to each other. F does not sit any corner side of the table. Here Case 1 is ruled out now. So, the final arrangement-

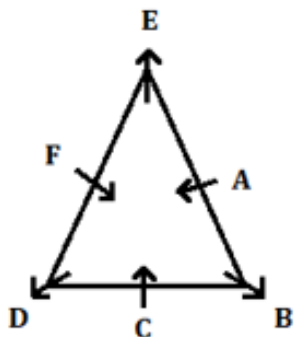

S9. Ans.(a)

Sol. From the given statements, B sits immediate to the right of C. One person sits between B and E. Here we get 4 possibilities i.e., Case 1, Case 2, Case 3 and Case 4.

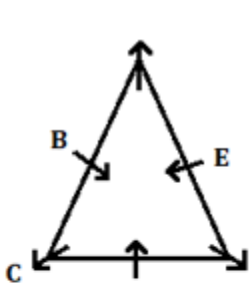

Case 3

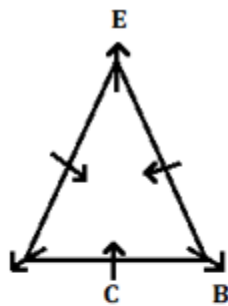

Case 4

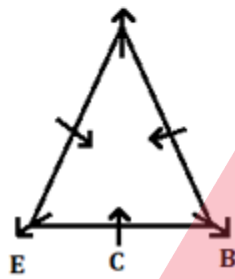
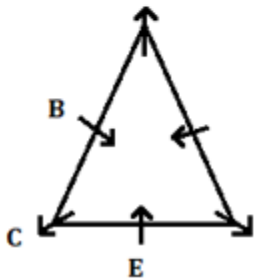

Two persons sit between A and D. From this condition Case 3 and Case 4 are eliminated.

Case 1

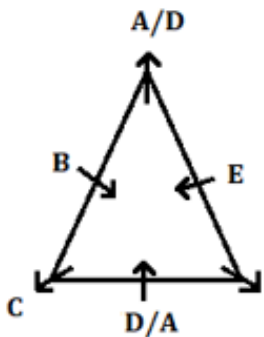

Case 2

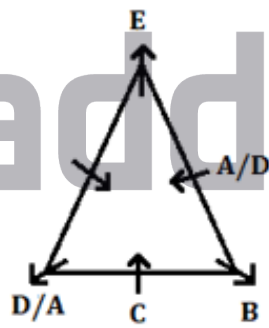

Both A and F are not sitting adjacent to each other. F does not sit any corner side of the table. Here Case 1 is ruled out now. So, the final arrangement-

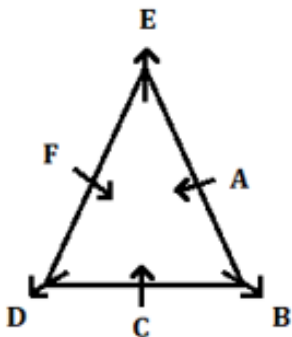

S10. Ans.(b)

Sol. From the given statements, B sits immediate to the right of C. One person sits between B and E. Here we get 4 possibilities i.e., Case 1, Case 2, Case 3 and Case 4.

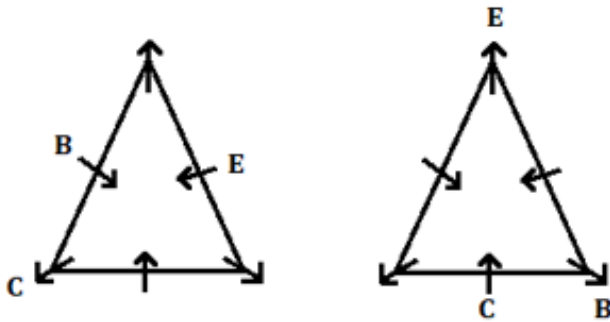

Case 3

Case 4

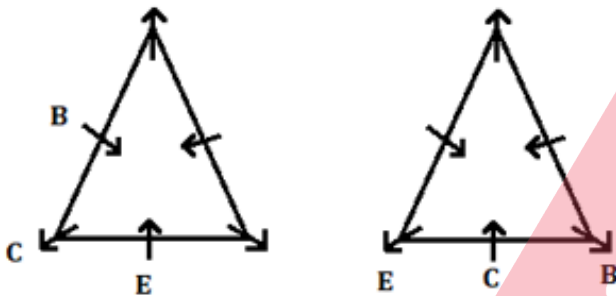

Case 1

Case 2

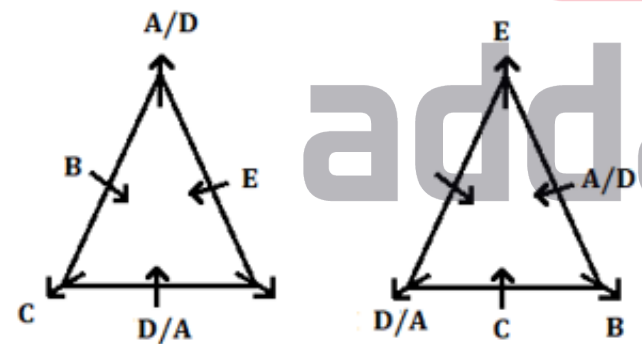

Two persons sit between A and D. From this condition Case 3 and Case 4 are eliminated. Both A and F are not sitting adjacent to each other. F does not sit any corner side of the table. Here Case 1 is ruled out now. So, the final arrangement-

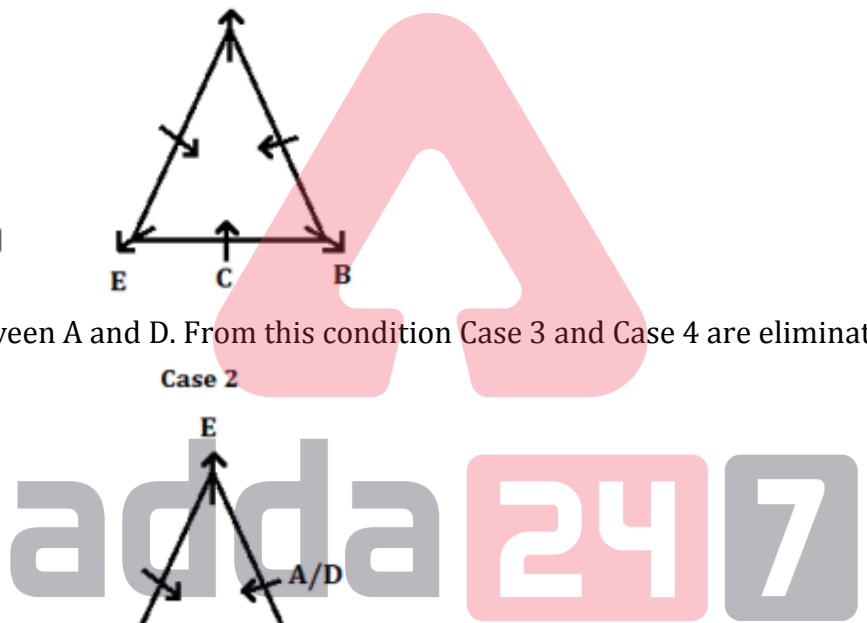
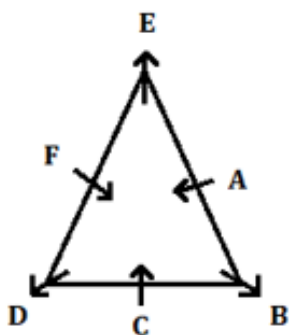

Bilingual

 **Special Offer**

**IBPS 2022
RRB PO
PRELIMS**

with Video Solutions

55+ TOTAL TESTS

S11. Ans.(b)

Sol. From the given statements, B sits immediate to the right of C. One person sits between B and E. Here we get 4 possibilities i.e., Case 1, Case 2, Case 3 and Case 4.

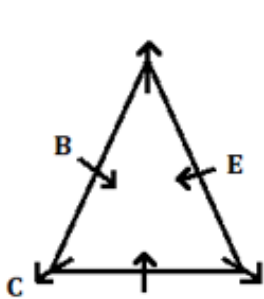

Case 3

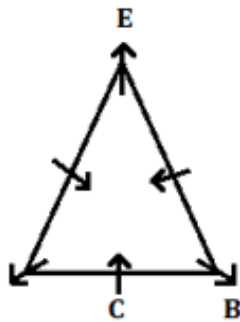

Case 4

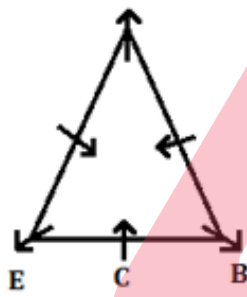
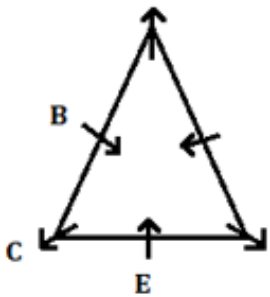

Two persons sit between A and D. From this condition Case 3 and Case 4 are eliminated.

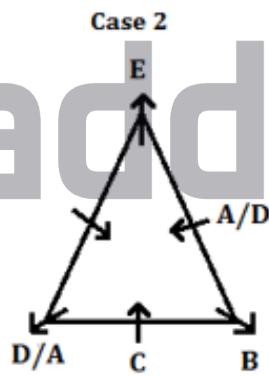
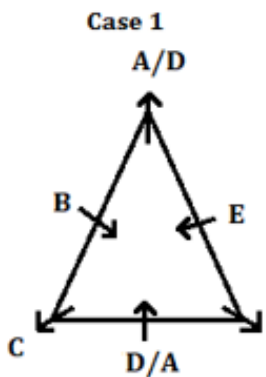

Both A and F are not sitting adjacent to each other. F does not sit any corner side of the table. Here Case 1 is ruled out now. So, the final arrangement-

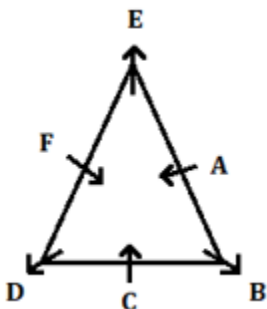

S12. Ans.(d)

Sol.

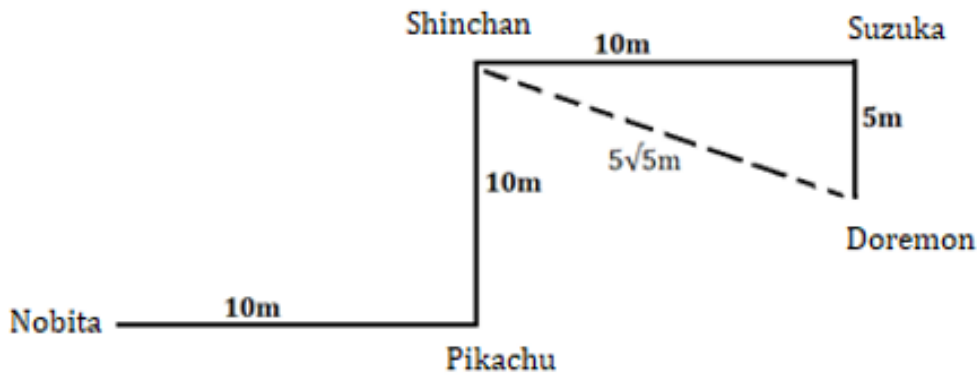

S13. Ans.(a)

Sol.

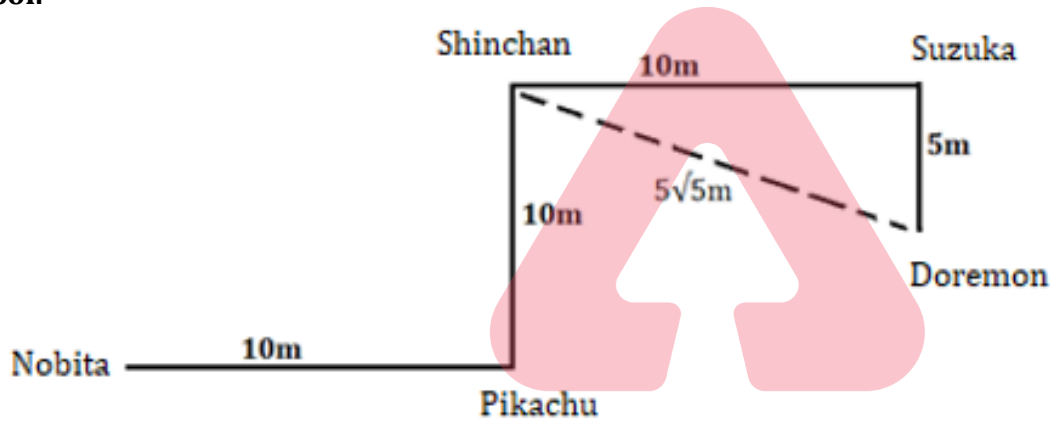

S14. Ans.(d)

Sol.

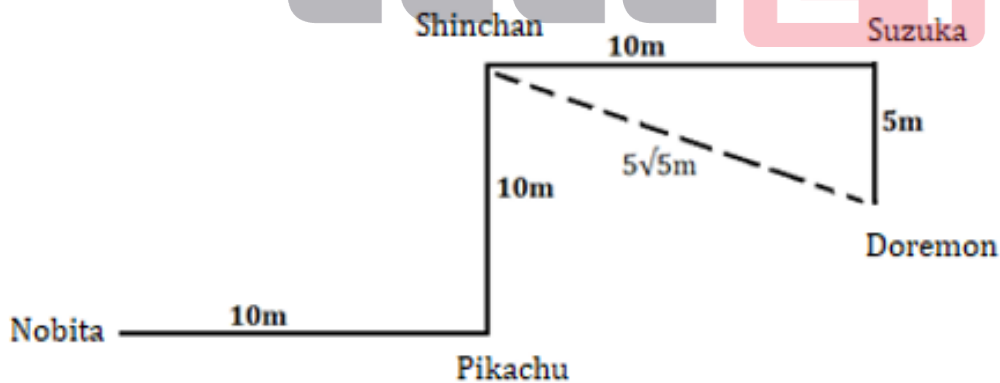

S15. Ans.(a)

S16. Ans.(a)

Sol. From the given conditions, Q sits second to the right of V. One person sits between Q and R. here there are two cases possible i.e., case1 and case2.

Case 1

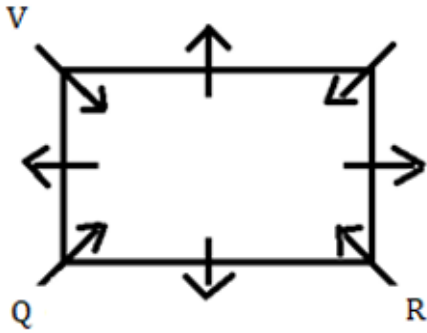

Case 2

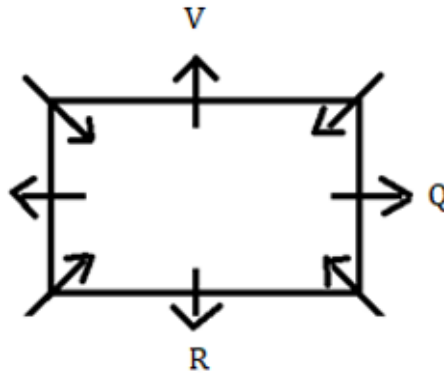

Two persons sit between R and W. P sits to the immediate left of S. One person sits between S and T. T does not sit next to V. here there are two more cases possible i.e., case1.a and case 2a.

Case 1

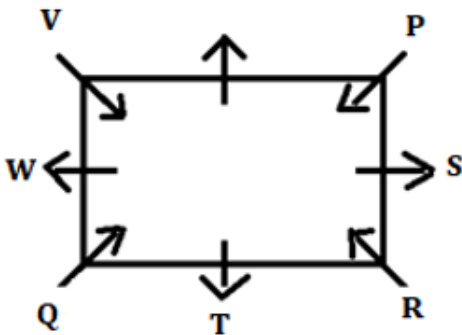

Case 2

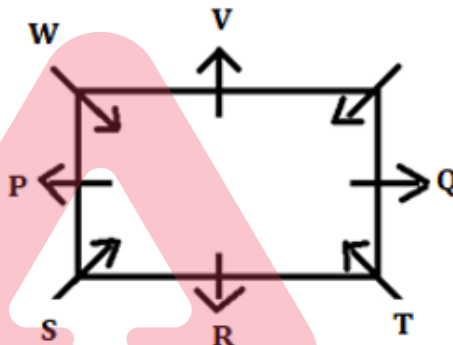

Case 1a

Case 2a

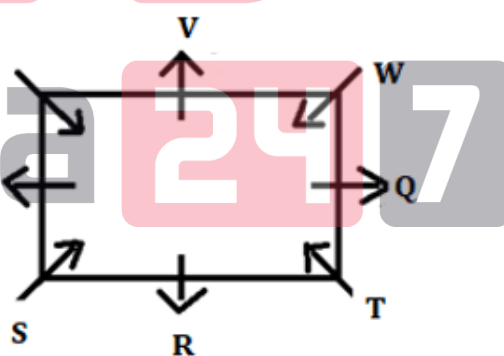
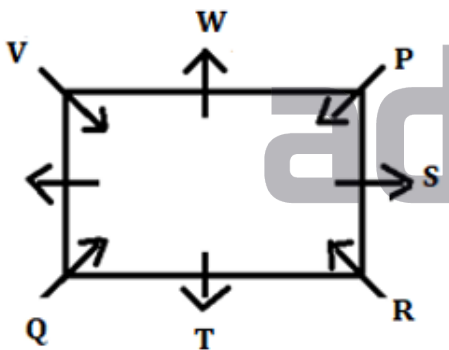

U does not face away from the centre of table and do not sits next to P. here case 1, Case 1a and case 2a gets eliminated. So, the final solution is-

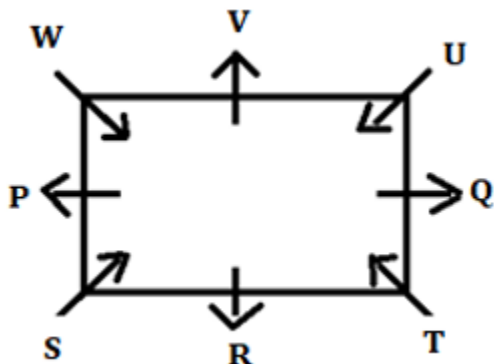

S17. Ans.(b)

Sol. From the given conditions, Q sits second to the right of V. One person sits between Q and R. here there are two cases possible i.e., case1 and case2.

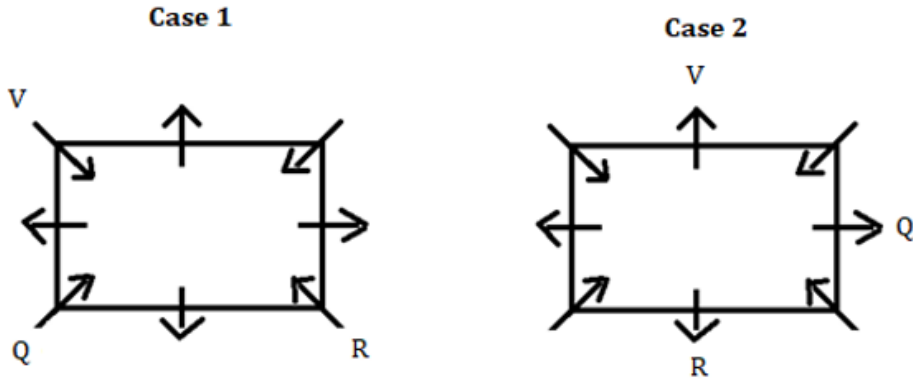

Two persons sit between R and W. P sits to the immediate left of S. One person sits between S and T. T does not sit next to V. here there are two more cases possible i.e., case1.a and case 2a.

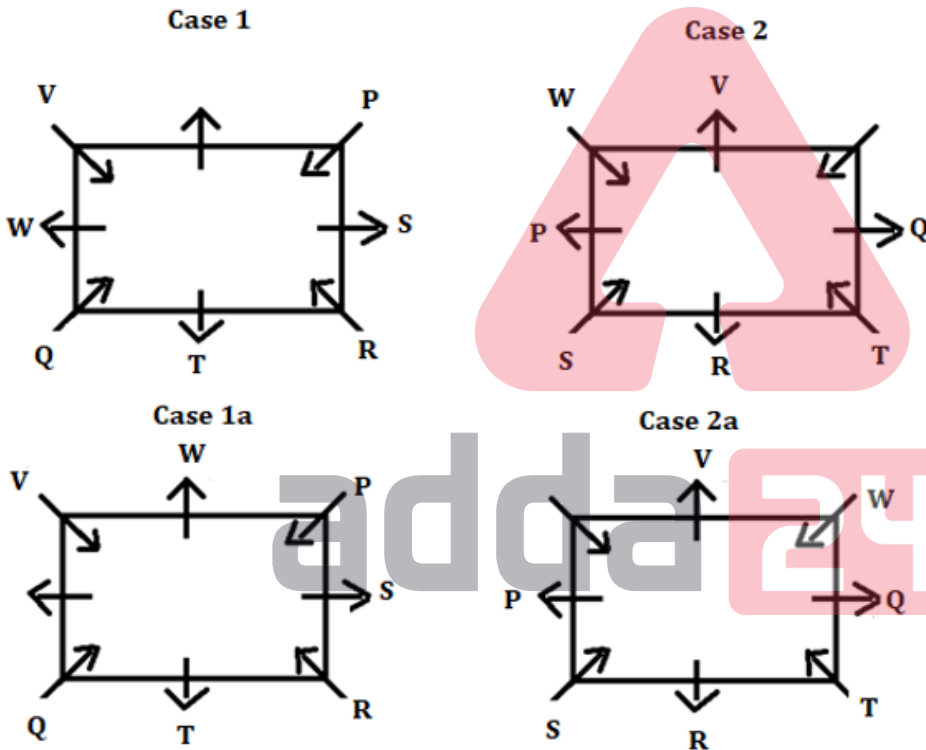

U does not face away from the centre of table and do not sits next to P. here case 1, Case 1a and case 2a gets eliminated. So, the final solution is-

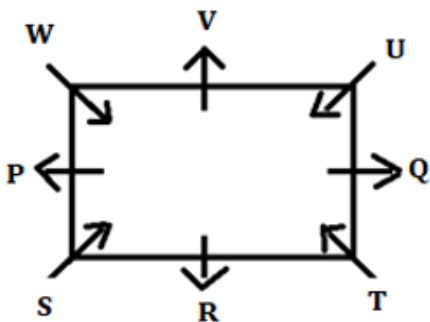

NRA-CET Ready

BANK MAHA PACK

Live Class, Video Course, Test Series, eBooks

Bilingual (with eBooks)

S18. Ans.(c)

Sol. From the given conditions, Q sits second to the right of V. One person sits between Q and R. here there are two cases possible i.e., case1 and case2.

Case 1

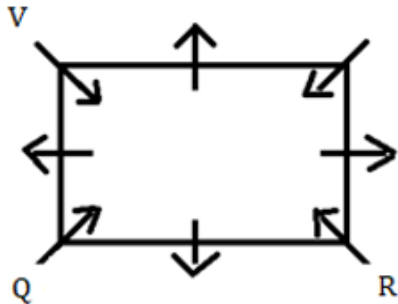

Case 2

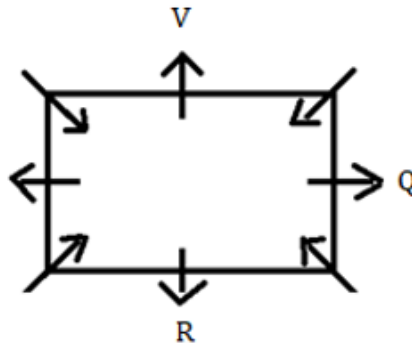

Two persons sit between R and W. P sits to the immediate left of S. One person sits between S and T. T does not sit next to V. here there are two more cases possible i.e., case1.a and case 2a.

Case 1

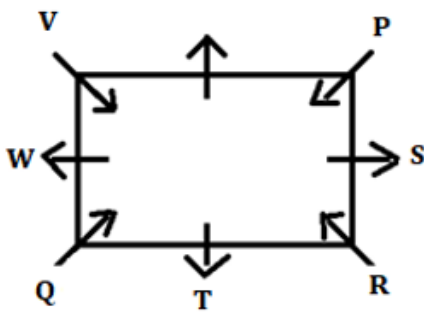

Case 2

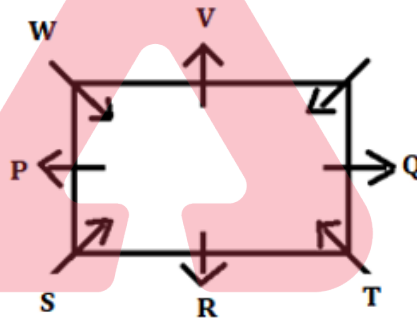

Case 1a

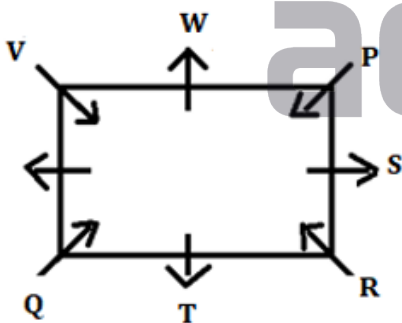

Case 2a

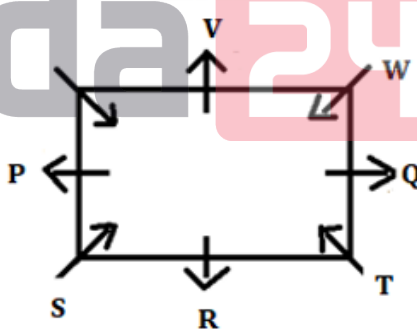

U does not face away from the centre of table and do not sits next to P. here case 1, Case 1a and case 2a gets eliminated. So, the final solution is-

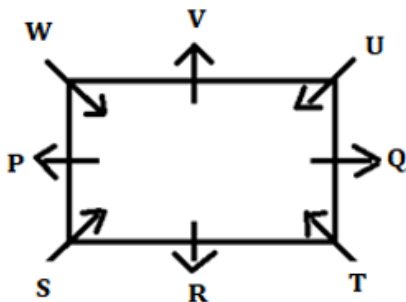

S19. Ans.(d)

Sol. From the given conditions, Q sits second to the right of V. One person sits between Q and R. here there are two cases possible i.e., case1 and case2.

Case 1

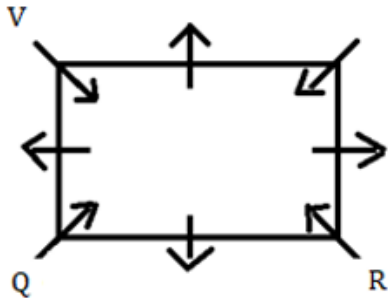

Case 2

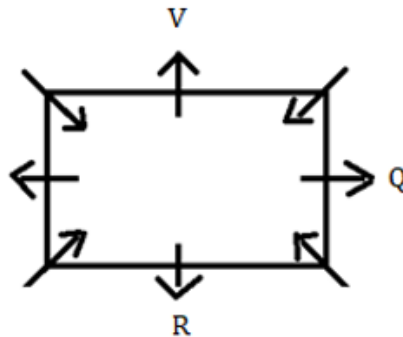

Two persons sit between R and W. P sits to the immediate left of S. One person sits between S and T. T does not sit next to V. here there are two more cases possible i.e., case1.a and case 2a.

Case 1

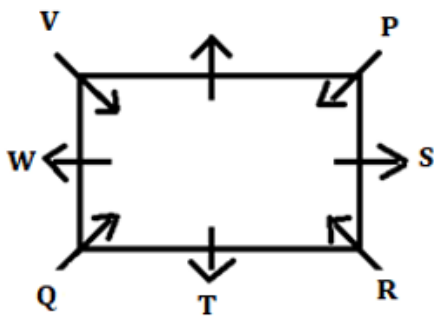

Case 2

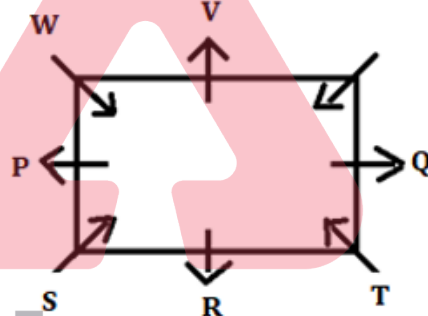

Case 1a

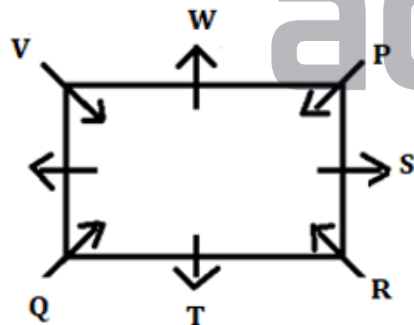

Case 2a

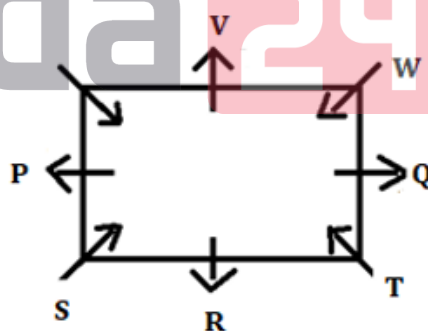

U does not face away from the centre of table and do not sits next to P. here case 1, Case 1a and case 2a gets eliminated. So, the final solution is-

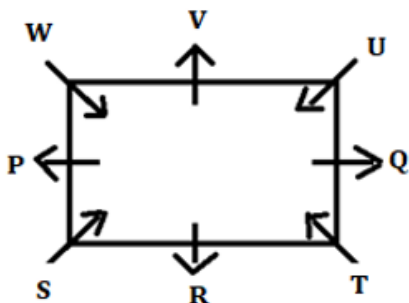

S20. Ans.(e)

Sol. From the given conditions, Q sits second to the right of V. One person sits between Q and R. here there are two cases possible i.e., case1 and case2.

Case 1

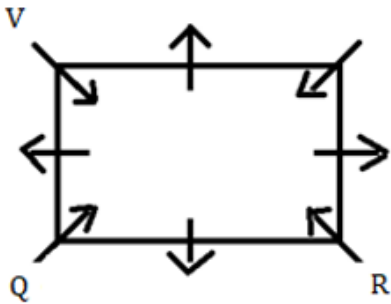

Case 2

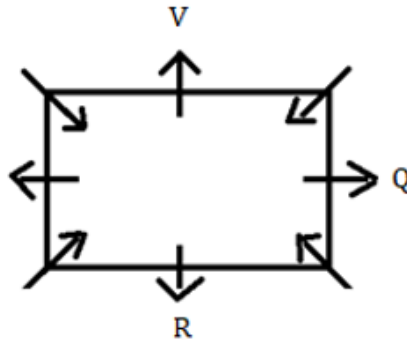

Two persons sit between R and W. P sits to the immediate left of S. One person sits between S and T. T does not sit next to V. here there are two more cases possible i.e., case1.a and case 2a.

Case 1

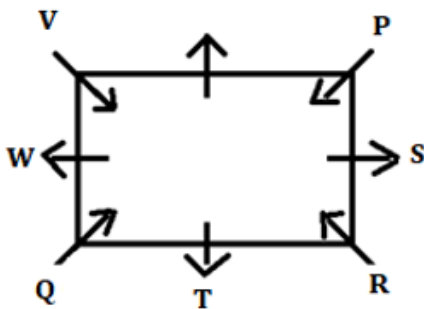

Case 2

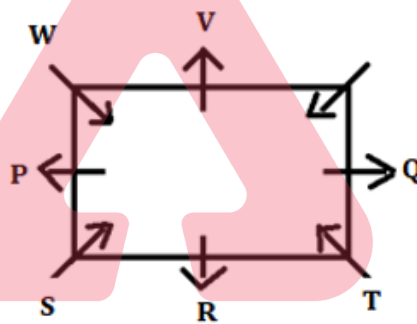

Case 1a

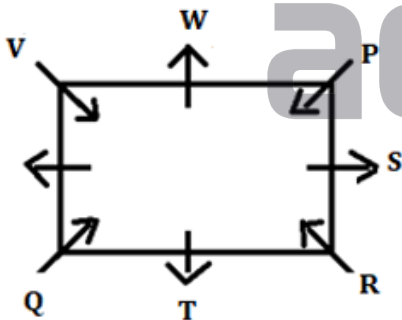

Case 2a

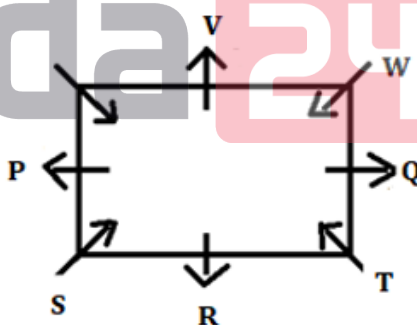

U does not face away from the centre of table and do not sits next to P. here case 1, Case 1a and case 2a gets eliminated. So, the final solution is-

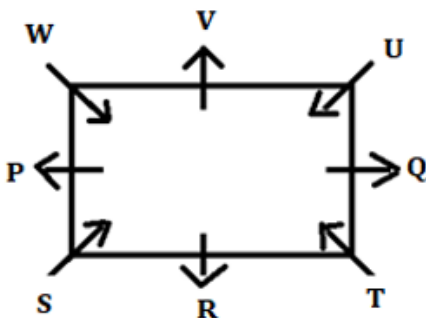

S21. Ans.(e)
Sol.

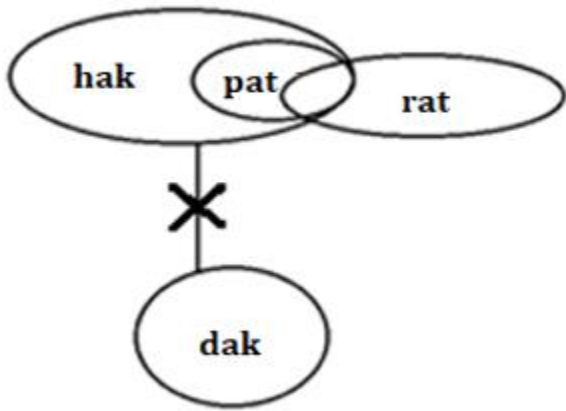

S22. Ans.(c)
Sol.

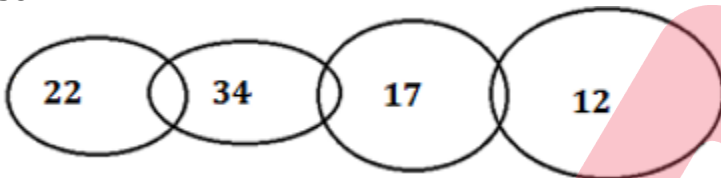

S23. Ans.(d)
Sol.

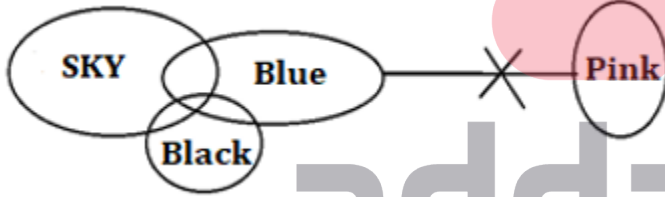

S24. Ans.(b)
Sol.

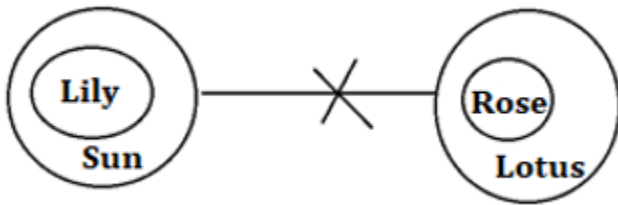

S25. Ans.(d)
Sol.

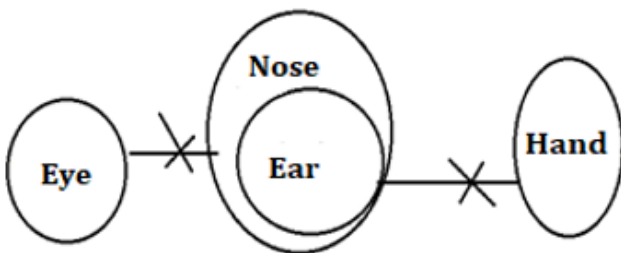

S26. Ans.(c)

Sol.

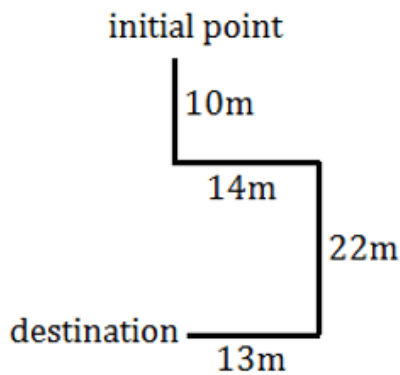

S27. Ans.(a)

Sol.

$$C > D > E > F > A > B$$

150 130

S28. Ans.(b)

Sol.

$$C > D > E > F > A > B$$

150 130

S29. Ans.(a)

Sol. It is given that X is getting married in the month having 31 days and does not marry on an odd date. one person is getting married between X and N. N and Q are getting married on same month. X and Z are getting married in the same month. M is getting married before P. N is not getting married on 23rd. Here we get 3 possibilities i.e., Case 1, Case 2 and Case 3.

Month	Dates	Case 1	Case 2	Case 3
		Persons	Persons	Persons
June	18	N	M	M
	23	Q	P	P
August	18	X	N	X
	23	Z	Q	Z
October	18	M	X	N
	23	P	Z	Q

Not more than one person gets married between M and N. So, case 1 and Case 3 get eliminated and we get the final arrangement -

Month	Dates	Persons
June	18	M
	23	P
August	18	N
	23	Q
October	18	X
	23	Z

S30. Ans.(e)

Sol. It is given that X is getting married in the month having 31 days and does not marry on an odd date. one person is getting married between X and N. N and Q are getting married on same month. X and Z are getting married in the same month. M is getting married before P. N is not getting married on 23rd. Here we get 3 possibilities i.e., Case 1, Case 2 and Case 3.

Month	Dates	Case 1	Case 2	Case 3
		Persons	Persons	Persons
June	18	N	M	M
	23	Q	P	P
August	18	X	N	X
	23	Z	Q	Z
October	18	M	X	N
	23	P	Z	Q

Not more than one person gets married between M and N. So, case 1 and Case 3 get eliminated and we get the final arrangement -

Month	Dates	Persons
June	18	M
	23	P
August	18	N
	23	Q
October	18	X
	23	Z

S31. Ans.(b)

Sol. It is given that X is getting married in the month having 31 days and does not marry on an odd date. one person is getting married between X and N. N and Q are getting married on same month. X and Z are getting married in the same month. M is getting married before P. N is not getting married on 23rd. Here we get 3 possibilities i.e., Case 1, Case 2 and Case 3.

Month	Dates	Case 1	Case 2	Case 3
		Persons	Persons	Persons
June	18	N	M	M
	23	Q	P	P
August	18	X	N	X
	23	Z	Q	Z
October	18	M	X	N
	23	P	Z	Q

Not more than one person gets married between M and N. So, case 1 and Case 3 get eliminated and we get the final arrangement -

Month	Dates	Persons
June	18	M
	23	P
August	18	N
	23	Q
October	18	X
	23	Z

S32. Ans.(d)

Sol. It is given that X is getting married in the month having 31 days and does not marry on an odd date. one person is getting married between X and N. N and Q are getting married on same month. X and Z are getting married in the same month. M is getting married before P. N is not getting married on 23rd. Here we get 3 possibilities i.e., Case 1, Case 2 and Case 3.

Month	Dates	Case 1	Case 2	Case 3
		Persons	Persons	Persons
June	18	N	M	M
	23	Q	P	P
August	18	X	N	X
	23	Z	Q	Z
October	18	M	X	N
	23	P	Z	Q

Not more than one person gets married between M and N. So, case 1 and Case 3 get eliminated and we get the final arrangement -

Month	Dates	Persons
June	18	M
	23	P
August	18	N
	23	Q
October	18	X
	23	Z

S33. Ans.(c)

Sol. It is given that X is getting married in the month having 31 days and does not marry on an odd date. one person is getting married between X and N. N and Q are getting married on same month. X and Z are getting married in the same month. M is getting married before P. N is not getting married on 23rd. Here we get 3 possibilities i.e., Case 1, Case 2 and Case 3.

Month	Dates	Case 1	Case 2	Case 3
		Persons	Persons	Persons
June	18	N	M	M
	23	Q	P	P
August	18	X	N	X
	23	Z	Q	Z
October	18	M	X	N
	23	P	Z	Q

Not more than one person gets married between M and N. So, case 1 and Case 3 get eliminated and we get the final arrangement -

Month	Dates	Persons
June	18	M
	23	P
August	18	N
	23	Q
October	18	X
	23	Z

S34. Ans.(e)

Sol. I. $Y > B$ (True) II. $B < M$ (True)

S35. Ans.(b)

Sol. I. $M \geq B$ (False) II. $M < A$ (True)

S36. Ans.(a)

Sol. From the given statements, K faces to the one who sits immediate to the right of O. K sits 2nd from one of the ends of the row. Here we get 2 possibilities i.e. Case 1 and Case 2. N faces the one who sits 3rd to the right of B.

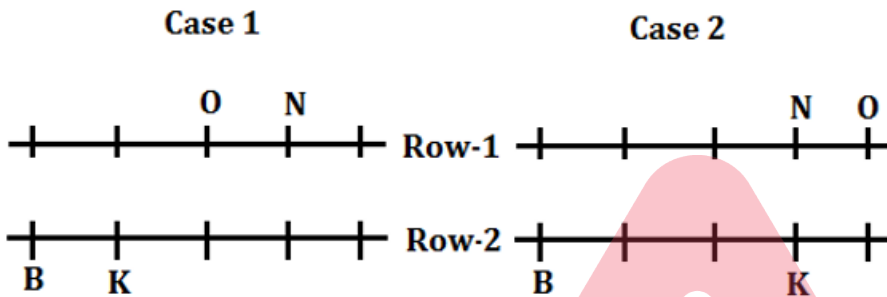

From the given statements, only one person sits between A and L, who faces M. C sits to the right of K. Here Case 2 is ruled out now. More than one person's sit between Q and N.

So, the final arrangement is-

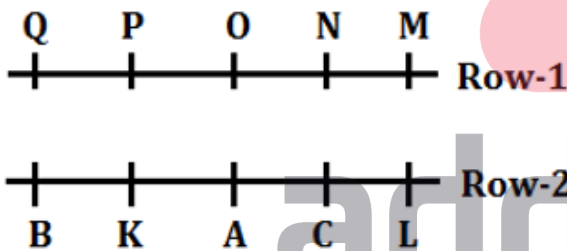

S37. Ans.(a)

Sol. From the given statements, K faces to the one who sits immediate to the right of O. K sits 2nd from one of the ends of the row. Here we get 2 possibilities i.e. Case 1 and Case 2. N faces the one who sits 3rd to the right of B.

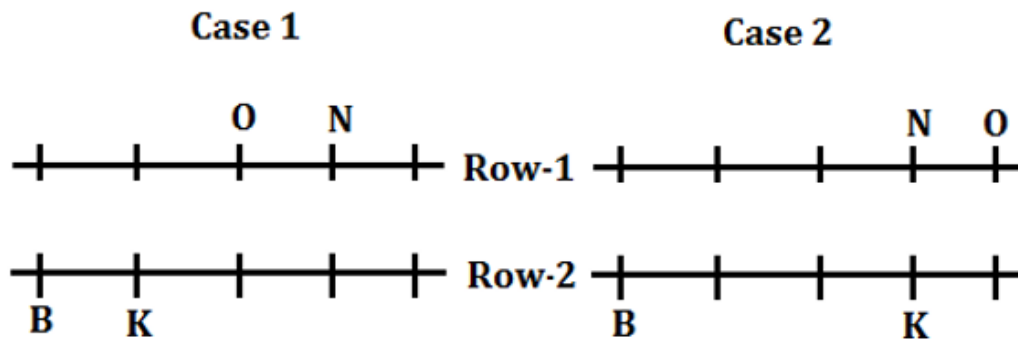

From the given statements, only one person sits between A and L, who faces M. C sits to the right of K. Here Case 2 is ruled out now. More than one person's sit between Q and N.

So, the final arrangement is-

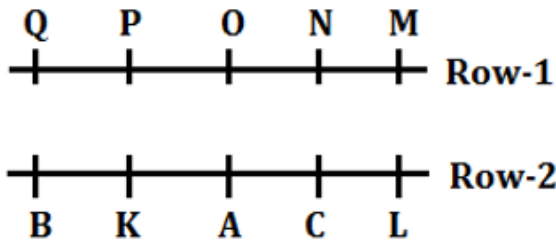

S38. Ans.(a)

Sol. From the given statements, K faces to the one who sits immediate to the right of O. K sits 2nd from one of the ends of the row. Here we get 2 possibilities i.e. Case 1 and Case 2. N faces the one who sits 3rd to the right of B.

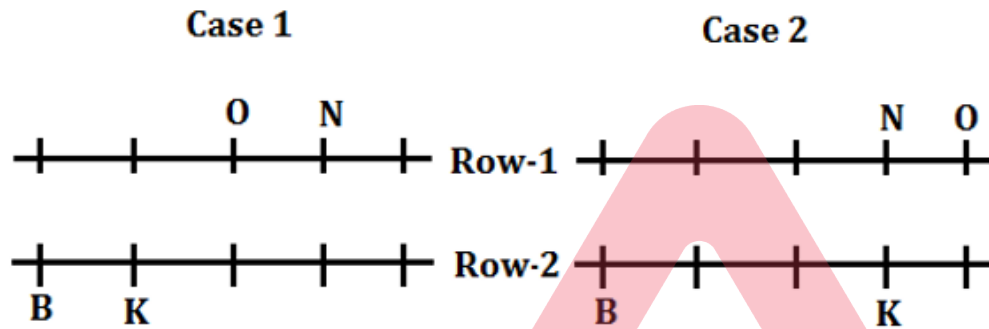

From the given statements, only one person sits between A and L, who faces M. C sits to the right of K. Here Case 2 is ruled out now. More than one person's sit between Q and N.

So, the final arrangement is-

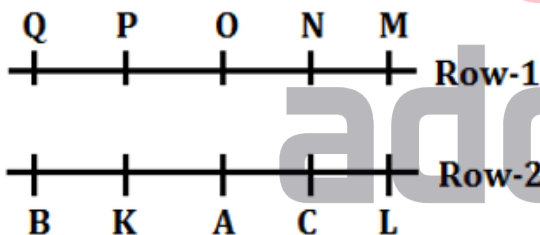

S39. Ans.(d)

Sol. From the given statements, K faces to the one who sits immediate to the right of O. K sits 2nd from one of the ends of the row. Here we get 2 possibilities i.e. Case 1 and Case 2. N faces the one who sits 3rd to the right of B.

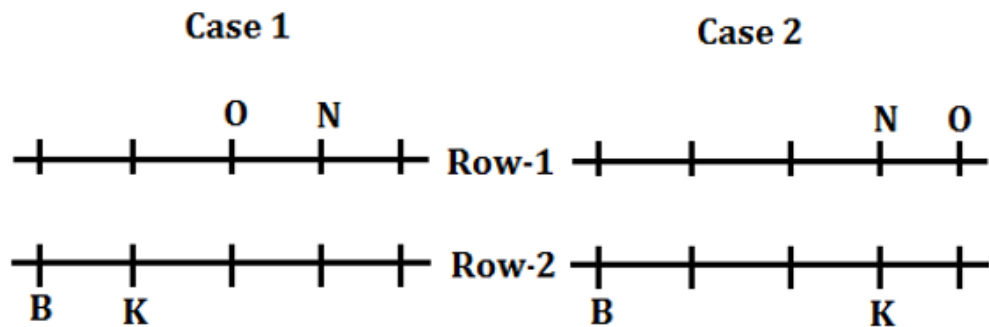

From the given statements, only one person sits between A and L, who faces M. C sits to the right of K. Here Case 2 is ruled out now. More than one person's sit between Q and N.

So, the final arrangement is-

Q P O N M
 ┆ ┆ ┆ ┆ ┆ Row-1

┆ ┆ ┆ ┆ ┆ Row-2
 B K A C L

S40. Ans.(e)

Sol. 8639726545

6893275654

$$3 + 5 = 8$$

S41. Ans.(d)

Sol. Number of candidates who did not cleared mains examination in 2018

$$= 25000 \times \frac{1}{5} \times \frac{(100-25)}{100} = 3750$$

S42. Ans.(c)

Sol.

$$\text{Number of candidates who qualified for mains in 2016} = 24000 \times \frac{3}{8} = 9000$$

$$\text{Number of candidates who did not qualified for mains in 2020} = 55000 \times \frac{9}{11} = 45000$$

$$\text{So, required ratio} = \frac{9000}{45000} = \frac{1}{5}$$

S43. Ans.(a)

Sol.

$$\text{Required average} = \frac{1}{2} \times \left[32000 \times \frac{5}{16} + 40000 \times \frac{3}{10} \right]$$

$$= \frac{1}{2} \times (10000 + 12000) = 11000$$

S44. Ans.(d)

Sol.

$$\text{Total number of candidates who cleared mains in 2017} = 32000 \times \frac{5}{16} \times \frac{18}{100} = 1800$$

$$\text{Total number of candidates who cleared mains in 2019} = 40000 \times \frac{3}{10} \times \frac{12.5}{100} = 1500$$

$$\text{So, required percentage} = \frac{1800-1500}{1500} \times 100 = 20\%$$

S45. Ans.(b)

Sol.

$$\text{Required number of candidates} = 55000 \times \frac{2}{11} \times \frac{20}{100} \times \frac{10}{100} = 200$$

S46. Ans.(a)

Sol.

$$\frac{58}{100} \times \frac{250}{29} + 144 = ? + 18$$
$$? = 149 - 18$$
$$? = 131$$

S47. Ans.(d)

Sol.

$$\sqrt[8]{48 \times 36} + \frac{20}{100} \times 120 = ?$$
$$12 + 24 = ?$$
$$? = 36$$

S48. Ans.(c)

Sol.

$$\frac{42}{100} \times 900 - 27 \times 9 = ? \times 15$$
$$378 - 243 = ? \times 15$$
$$? = \frac{135}{15}$$
$$? = 9$$

S49. Ans.(b)

Sol.

$$2310 \times \frac{1}{11} \times \frac{1}{15} - ? = \frac{1}{3} \times 30$$
$$14 - ? = 10$$
$$? = 4$$

S50. Ans.(d)

Sol.

$$\sqrt{784} \times \frac{25}{100} \times 75 - 19^2 = ?$$
$$\frac{28}{4} \times 75 - 361 = ?$$
$$? = 525 - 361$$
$$? = 164$$

S51. Ans.(c)

Sol.

Total quantity in final mixture = $375 + 60 + 40 = 475$ liters

So, quantity of water in final mixture = $475 \times \frac{9}{19} = 225$ liters

And quantity of spirit in final mixture = $475 - 225 = 250$ liters

ATQ

$$\frac{p}{q} = \frac{225-60}{250-40} = \frac{165}{210}$$

$$\frac{p}{Q} = \frac{11}{14}$$

TEST SERIES
BILINGUAL
VIDEO SOLUTIONS



IBPS CLERK 2022
PRELIMS + MAINS

90+ Total Tests | eBooks



adda247

S52. Ans.(a)

Sol.

Total cost of 15 articles = $15 \times 60 = \text{Rs. } 900$

Selling price of $\frac{1}{3}$ rd articles = $\frac{15}{3} \times 60 \times \frac{140}{100} = \text{Rs. } 420$

Selling price of $\frac{4}{5}$ th of the remaining articles = $(15 - \frac{15}{3}) \times \frac{4}{5} \times 60 = \text{Rs. } 480$

Selling price of remaining articles = $\{15 - [\frac{15}{3} + (15 - \frac{15}{3}) \times \frac{4}{5}]\} \times 60 \times \frac{80}{100} = \text{Rs. } 96$

Total selling price = $420 + 480 + 96 = \text{Rs. } 996$

So, required profit = $996 - 900 = \text{Rs. } 96$

S53. Ans.(e)

Sol.

Let present ages of Raghav and his father be $5x$ and $14x$ respectively.

ATQ

$$\frac{5x+7}{14x+7} = \frac{3}{7}$$

$$35x + 49 = 42x + 21$$

$$7x = 28$$

$$x = 4$$

So, present ages of Raghav and his father be 20 years and 56 years respectively.

Now, let present age of Raghav's mother be T years.

$$\text{So, } 20 + 56 + T = 43 \times 3$$

$$T = 129 - 76$$

$$T = 53 \text{ years}$$

S54. Ans.(a)

Sol.

Ratio of profit share of A, B, C and D *respectively* = $28000:40000:36000:52000$
= $7:10:9:13$

$$\text{So, required difference} = \frac{13-10}{39} \times 19500 \\ = 1500$$

S55. Ans.(c)

Sol.

Let efficiency of a man = $2a$ unit/day

So, a woman = a unit/day

Now,

$18 (18 \times 2a + 12 \times a) = \text{Total work}$

$$\text{Time taken by 8 men} = \frac{18(36a+12a)}{8 \times 2a} = 54 \text{ days}$$

S56. Ans.(a)

Sol.

Let the sum be Rs. P and rate of interest be R%.

ATQ,

$$(5P - P) = \frac{P \times R \times 16}{100}$$

$$4P = \frac{P \times R \times 16}{100}$$

$$R = 25\%$$

Now,

$$P \left[\left(1 + \frac{25}{100} \right)^2 - 1 \right] = 720$$

$$P \times \frac{9}{16} = 720$$

$$P = \text{Rs. } 1280$$

S57. Ans.(d)

Sol.

Let speed of boat in still water be x kmph

ATQ

$$\frac{D}{x-6} = 10$$

$$D = 10(x - 6) \text{ --- (i)}$$

And,

$$\frac{D}{x+6} = 4$$

$$D = 4(x + 6) \text{ --- (ii)}$$

From (i) and (ii)

$$10(x - 6) = 4(x + 6)$$

$$10x - 60 = 4x + 24$$

$$6x = 84$$

$$x = 14 \text{ kmph}$$

$$\text{So, required distance (D)} = 10 \times (14 - 6) = 80 \text{ km}$$

S58. Ans.(a)

Sol.

Equivalent discount percentage of two discounts of 20% & 25%

$$= -20 + (-25) + \frac{(-20) \times (-25)}{100}$$

$$= -40\%$$

$$\text{So, marked price of mobile} = \frac{18,000}{(100-40)} \times 100 = \text{Rs. } 30,000$$

S59. Ans.(a)

Sol. Let length and breadth of the rectangle be l and b cm respectively.

ATQ

$$\frac{2(l+b)}{l} = \frac{16}{5}$$

$$10l + 10b = 16l$$

$$3l = 5b$$

$$\frac{l}{b} = \frac{5}{3}$$

Let length and breadth of rectangle be $5x$ and $3x$ respectively.

$$5x \times 3x = 375$$

$$x^2 = 25$$

$$x = 5$$

So, breadth of the rectangle = 15 cm

S60. Ans.(b)

Sol.

$$\frac{20}{100}(X + 2500) = \frac{40}{100}(X + 900)$$

$$0.2X + 500 = 0.4X + 360$$

$$0.2X = 140$$

$$X = 700$$

$$50\% \text{ of } X = \frac{50}{100} \times 700 = 350$$

S61. Ans.(c)

Sol.

$$\text{Required percentage} = \frac{(40+20)-(25+25)}{(25+25)} \times 100$$

$$= \frac{10}{50} \times 100 = 20\%$$

S62. Ans.(d)

Sol.

$$\text{Required average} = \frac{1}{5} \times [25 + 30 + 40 + 25 + 20]$$

$$= \frac{140}{5} = 28$$

S63. Ans.(b)

Sol.

$$\text{Number of cakes sold by A on Saturday} = 35 \times \frac{9}{7} = 45$$

$$\text{Number of cakes sold by B on Saturday} = 40 \times \frac{115}{100} = 46$$

$$\text{So, required sum} = 45 + 46 = 91$$

S64. Ans.(a)

Sol.

$$\text{Required ratio} = \frac{20+30+25}{40+25+20}$$

$$= \frac{75}{85} = \frac{15}{17}$$

S65. Ans.(b)

Sol. Total number of cakes sold by A in these five days =40+20+30+25+35=150

Total number of cakes sold by B in these five days =25+30+40+25+20=140

So, required difference =150-140=10

S66. Ans.(b)

Sol.

$$\frac{24}{100} \times 450 + \frac{27.5}{100} \times 200 = ?$$
$$108 + 55 = 163$$

S67. Ans.(c)

Sol.

$$? \times \frac{16}{25} \times \frac{5}{7} \times \frac{3}{8} \times 140 = 36$$
$$? \times 24 = 36$$
$$? = 1.5$$

S68. Ans.(a)

Sol.

$$16 - \frac{32}{4} = ?$$
$$? = 8$$

S69. Ans.(d)

Sol.

$$16484 - 9651 = ?$$
$$? = 6833$$

S70. Ans.(e)

Sol.

$$\frac{13}{3} + \frac{39}{4} - \frac{13}{12} + ? = \frac{4}{9} \times 72$$
$$\frac{52+117-13}{12} + ? = 32$$
$$? = 32 - 13$$
$$? = 19$$

S71. Ans.(a)

Sol.

$$27 + 529 + 20 = ?^2$$
$$?^2 = 576$$
$$? = 24$$

S72. Ans.(d)

Sol.

$$153 + 459 = ? \times 6$$
$$? = \frac{612}{6}$$
$$? = 102$$

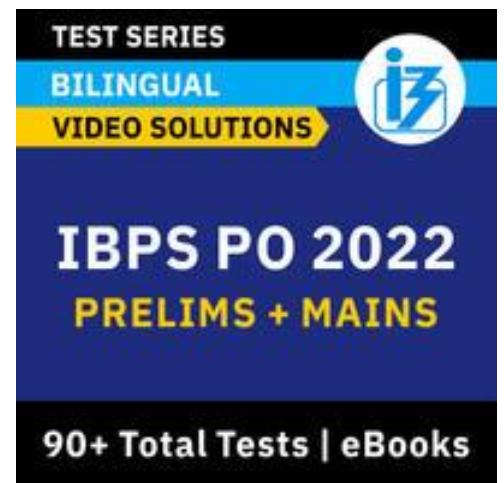

S73. Ans.(d)

Sol.

$$5^? = \frac{3125 \times 625}{125 \times 25}$$

$$5^? = 625$$

$$5^? = 5^4$$

$$? = 4$$

S74. Ans.(d)

Sol.

$$\frac{1}{4} \times 6 + 144 = ?$$

$$? = 145.5$$

S75. Ans.(a)

Sol.

$$600 - 48 = ? + 256$$

$$? = 296$$

S76. Ans.(c)

Sol.

The pattern of the series is-

$$9 + 5 = 14$$

$$14 + 15 = 29$$

$$29 + 25 = 54$$

$$54 + 35 = 89$$

$$89 + 45 = 134$$

$$134 + 55 = 189$$

So, the wrong no. is 179.

S77. Ans.(d)

Sol.

The pattern of the series is -

$$2 \times 1 + 1 = 3$$

$$3 \times 2 + 1 = 7$$

$$7 \times 3 + 1 = 22$$

$$22 \times 4 + 1 = 89$$

$$89 \times 5 + 1 = 446$$

$$446 \times 6 + 1 = 2677$$

So, the wrong no. is 1.



adda247

S78. Ans.(e)

Sol.

The pattern of the series is -

$$2^2 + 1 = 5$$

$$3^2 - 1 = 8$$

$$4^2 + 1 = 17$$

$$5^2 - 1 = 24$$

$$6^2 + 1 = 37$$

$$7^2 - 1 = 48$$

$$8^2 + 1 = 65$$

So, the wrong no. is 39.

S79. Ans.(c)

Sol.

The pattern of the series is-

$$32 \times 2 = 64$$

$$64 \div 4 = 16$$

$$16 \times 6 = 96$$

$$96 \div 8 = 12$$

$$12 \times 10 = 120$$

$$120 \div 12 = 10$$

So, the wrong no. is 8.

S80. Ans.(a)

Sol.

The pattern of the series is -

$$18 + 3 = 21$$

$$21 + 5 = 26$$

$$26 + 7 = 33$$

$$33 + 11 = 44$$

$$44 + 13 = 57$$

$$57 + 17 = 74$$

So, the wrong no. is 17.



Bilingual

Special Offer

**IBPS 2022
RRB PO
PRELIMS**

With Video Solutions

55+ TOTAL TESTS



adda247