

All India Mock for RBI Grade B 2024 (9-10 March)

Q1. Under the National Means cum Merit Scholarship Scheme (NMMSS), what is the maximum parental income limit for a student to be eligible for the scholarship?

- (a) Rs. 1,00,000/- per annum
- (b) Rs. 2,50,000/- per annum
- (c) Rs. 3,00,000/- per annum
- (d) Rs. 3,50,000/- per annum
- (e) Rs. 4,00,000/- per annum

Q2. What is the maximum transaction limit for which the Reserve Bank of India has waived the need for an Additional Factor of Authentication (AFA) for specific payment categories?

- (a) ₹50,000
- (b) ₹75,000
- (c) ₹1,00,000
- (d) ₹1,25,000
- (e) ₹1,50,000

Q3. Which of the following schemes is related to the Welfare of Minorities?

- (i) Nai Roshni
 - (ii) Pradhan Mantri Jan Vikas Karyakram (PMJVK)
 - (iii) USTTAD (Upgrading the Skills and Training in Traditional Arts/Crafts for Development)
 - (iv) Prime Minister-Virasat Ka Samvardhan (PM Vikaas)
 - (v) Naya Savera- Free Coaching and Allied Scheme
 - (vi) Padho Pardesh
- (a) Only (i), (ii) & (iii)
 - (b) Only (iii), (iv) & (v)
 - (c) Only (i), (ii), (iii) & (iv)
 - (d) Only (iii), (iv), (v) & (vi)
 - (e) All of the above

Q4. Recently (Jan 2024), the Union Cabinet has given the green light to the terms of reference (ToR) for the Sixteenth Finance Commission. This commission holds the critical responsibility of recommending the formula for revenue distribution between the Centre and the States for the upcoming five-year period starting from-

- (a) January 1, 2026
- (b) April 1, 2026
- (c) August 1, 2026
- (d) January 1, 2027
- (e) April 1, 2027

Q5. Every year on 1st December, World AIDS Day is commemorated globally to raise awareness about Human Immunodeficiency Virus (HIV)/Acquired Immuno Deficiency Syndrome (AIDS) and honor those who have succumbed to it. What is the theme for World AIDS Day in the year 2023?

- (a) End the Stigma
- (b) Let communities lead
- (c) United to Fight AIDS
- (d) Solidarity for HIV/AIDS Prevention
- (e) A World Without AIDS

Q6. The National Crisis Management Committee (NMC) recently (December 2023) convened to assess the readiness of State governments and Central Ministries for the approaching cyclone 'Michaung' in the Bay of Bengal. It means strength and resilience. Which country suggested 'Michaung' for the tropical cyclone in the Bay of Bengal?

- (a) India
- (b) Bangladesh
- (c) Myanmar
- (d) Sri Lanka
- (e) Thailand

Q7. The main target of the Jan Shikshan Sansthan (JSS) Scheme is to impart vocational skills to the non-literates, neo-literates, and the persons having a rudimentary level of education and school dropouts up to 12th standard in the age group of _____, with due age relaxation in case of "Divyangjan" and other deserving cases. Priority is given to Women, SC, ST, OBC, and Minorities in the rural areas and urban low-income areas.

- (a) 15-45 years
- (b) 18-45 years
- (c) 21-50 years
- (d) 25-55 years
- (e) No age limits

Q8. Which organization won the "ISSA Vision Zero 2023" Award at the 23rd World Congress on Safety and Health at Work in Sydney, Australia?

- (a) International Labour Organization (ILO)
- (b) World Health Organization (WHO)
- (c) Employees' State Insurance Corporation (ESIC)
- (d) Occupational Safety and Health Administration (OSHA)
- (e) United Nations Development Programme (UNDP)

Q9. Which department is responsible for implementing the Watershed Development (WD) component of the Pradhan Mantri Krishi Sinchayee Yojana (PMKSY)?

- (a) Ministry of Jal Shakti
- (b) Department of Land Resources
- (c) Department of Agriculture and Farmers Welfare (DoA&FW)
- (d) Ministry of Environment, Forest and Climate Change
- (e) Ministry of Rural Development

Q10. Which bank has developed the 'Offline Retail Payments' product that received approval from the Reserve Bank of India (RBI)?

- (a) State Bank of India
- (b) HDFC Bank
- (c) ICICI Bank
- (d) Axis Bank
- (e) Punjab National Bank

Q11. The Ministry of Rural Development through DAY-NRLM provides a Vulnerability Reduction Fund (VRF) up to ____X____ per Village Organization (VO). Fill in the blank (X).

- (a) Rs. 3,50,000
- (b) Rs. 3,00,000
- (c) Rs. 2,50,000
- (d) Rs. 2,00,000
- (e) Rs. 1,50,000

**RBI P2I
BATCH 4.0**
*Live Foundation Batch
Target 2024*

Starts: 11 Mar | 6 am - 10 pm

Q12. The Ministry of Culture administers a Scheme by the name of “Scheme for Financial Assistance for Veteran Artists” for senior artists aged 60 years and above who have contributed significantly in their specialized fields of performing arts and culture but are facing financial difficulties due to old age. Under this scheme what is the amount of financial assistance provided monthly to the selected artists?

- (a) Rs. 4,000/-
- (b) Rs. 5,000/-
- (c) Rs. 6,000/-
- (d) Rs. 7,000/-
- (e) Rs. 8,000/-

Q13. What minimum asset value is required for Small & Medium REITs (SM REITs) as per the amended Real Estate Investment Trusts (REITs) Regulations approved by the SEBI board?

- (a) ₹10 crore
- (b) ₹25 crore
- (c) ₹50 crore
- (d) ₹75 crore
- (e) ₹100 crore

Q14. Under the Pradhan Mantri Fasal Bima Yojana, within how many days are the designated block/district level grievance redressal officers required to respond to grievances?

- (a) Within 3 days of receipt of the grievance
- (b) Within 5 days of receipt of the grievance
- (c) Within 7 days of receipt of the grievance
- (d) Within 10 days of receipt of the grievance
- (e) Within 14 days of receipt of the grievance

Q15. Which of the following statements is not correctly brought out related to the PM-KISAN scheme?

- (a) It is a central sector scheme launched in February 2019 to supplement the financial needs of land-holding farmers.
- (b) Under this scheme, the financial benefit of Rs 6,000/- per year in three equal installments every four months is transferred into the bank accounts of farmers' families across the country through Direct Benefit Transfer (DBT) mode.
- (c) The Ministry of Agriculture and Farmers Welfare is implementing it.
- (d) All superannuated/retired pensioners whose monthly pension is Rs.5,000/-or more (Excluding Multi-Tasking Staff / Class IV/Group D employees) of the above category shall not be eligible for benefit under the scheme.
- (e) All are correct.

Q16. Which cultural heritage from India was inscribed in the Representative List of Intangible Cultural Heritage (ICH) of Humanity by UNESCO during the 18th meeting of the Intergovernmental Committee for the Safeguarding of the Intangible Cultural Heritage in 2023?

- (a) Baul Singing of West Bengal
- (b) Ramlila of North India
- (c) Garba of Gujarat
- (d) Kathakali Dance of Kerala
- (e) Chhau Dance of Eastern India

Q17. Which city was reported as the safest in India for the third consecutive year in the NCRB's "Crime in India 2022" report?

- (a) Mumbai, Maharashtra
- (b) Bengaluru, Karnataka
- (c) Kolkata, West Bengal
- (d) Chennai, Tamil Nadu
- (e) Faridabad, Haryana

Q18. The Agriculture Infrastructure Fund (AIF) envisages the creation of post-harvest management infrastructure and community farming assets through incentives and financial support. How many years is the interest subvention available under the AIF for each project location?

- (a) 5 years
- (b) 6 years
- (c) 7 years
- (d) 8 years
- (e) 10 years

Q19. What is the primary aim of the Pradhan Mantri Annadata Aay SanraksHan Abhiyan (PM-AASHA)?

- (a) To provide subsidies for agricultural equipment
- (b) To offer crop insurance against natural disasters
- (c) To ensure Minimum Support Price (MSP) for produce of notified oilseeds, pulses, and copra
- (d) To promote organic farming and sustainable agricultural practices
- (e) To facilitate agricultural export and international trade

Q20. Recently (December 2023), the India Infrastructure Report (IIR) 2023 on Urban Planning and Development was released, it is a comprehensive document that covers various aspects of infrastructure planning, finance, and governance in the country. It has been released by which of the following organizations?

- (a) IDFC Foundation
- (b) Infrastructure Development Corporation (Karnataka) Ltd. (iDeCK)
- (c) National Institute of Urban Affairs (NIUA).
- (d) Only a & b
- (e) All a, b & c

Q21. Ayushman Bharat Pradhan Mantri — Jan Arogya Yojana (AB PM-JAY) has emerged as a hope in India's healthcare landscape, particularly for women. Data released by the Health Ministry reveals a significant contribution by women to the scheme's success, with approximately 49% of the total Ayushman cards attributed to them. What is the annual health coverage amount provided per family under the AB PM-JAY through Ayushman cards?

- (a) ₹1 lakh
- (b) ₹2 lakhs
- (c) ₹3 lakhs
- (d) ₹4 lakhs
- (e) ₹5 lakhs

Q22. Jacques Delors, who recently passed away at the age of 98, was known for his significant role in the formation of which major international entity?

- (a) United Nations
- (b) European Union
- (c) North Atlantic Treaty Organization
- (d) World Trade Organization
- (e) Association of Southeast Asian Nations

Q23. Which bank has been classified in Bucket 4 by the Reserve Bank of India (RBI) as a Domestic Systemically Important Bank (D-SIB) with an additional Common Equity Tier 1 (CET1) requirement of 0.80%?

- (a) HDFC Bank
- (b) ICICI Bank
- (c) Axis Bank
- (d) State Bank of India (SBI)
- (e) Kotak Mahindra Bank

Q24. The World Bank's latest report reveals India's leading position in global remittances, reaching \$125 billion in 2023. Apart from India, which of the following countries are among the top five remittance recipient countries?

(i) UAE

(ii) Japan

(iii) Mexico

(iv) Philippines

(v) Egypt

(vi) China

(a) Only (i), (ii) & (iii)

(b) Only (iii), (iv) & (v)

(c) Only (i), (ii), (iii) & (iv)

(d) Only (iii), (iv), (v) & (vi)

(e) None of the above

Q25. Which hospital has been ranked No.1 in the 'Best Multi-specialty Hospital Emerging' category by The Week-Hansa Research 2023?

(a) Apollo Hospitals, Chennai

(b) Fortis Hospital, Bangalore

(c) Aster Medcity, Kochi

(d) Max Healthcare, Delhi

(e) Manipal Hospital, Goa

Q26. What is the time frame within which the Reserve Bank of India requires Regulated Entities and their Internal Ombudsmen to communicate a final decision on customer complaints?

(a) 10 days

(b) 15 days

(c) 20 days

(d) 30 days

(e) 45 days

Q27. The Services Purchasing Managers' Index (PMI) in India revealed a decline to 56.9 in November, marking a one-year low compared to October's 58.4. What does it signify if the PMI of the current month is lower than the PMI of the previous month?

(a) The economy is expanding

(b) The economy is contracting

(c) There is no change in the economic conditions

(d) The inflation rate is increasing

(e) The unemployment rate is decreasing

Q28. According to the recent Periodic Labour Force Survey (PLFS) conducted by the National Sample Survey Office (NSSO), which state recorded the highest overall unemployment rate in the age group of 15 to 29 years in urban areas during the July-September quarter of 2023?

(a) Maharashtra

(b) Himachal Pradesh

(c) Tamil Nadu

(d) Kerala

(e) West Bengal

Q29. Which historical figure is being considered for the new name of Ayodhya's international airport, as the Yogi Adityanath government proposed?

(a) Maharishi Valmiki

(b) Goswami Tulsidas

(c) Maharishi Ved Vyas

(d) Swami Vivekananda

(e) Sant Kabir

Q30. The Reserve Bank of India (RBI) released a master direction on the Internal Ombudsman (IO) for lenders, aimed at harmonizing instructions applicable to various regulated entities. The directions aim to bring uniformity in various aspects. What new role has been introduced in the revised Internal Ombudsman mechanism as per RBI's master direction?

- (a) Chief Risk Officer
- (b) Deputy Internal Ombudsman
- (c) Chief Compliance Officer
- (d) Chief Financial Officer
- (e) Chief Technology Officer

Q31. The Securities and Exchanges Board of India (SEBI) has postponed the deadline for integrating the SEBI Complaint Redressal (SCORES) Platform with online dispute resolution platforms from December 4, 2023, to April 1, 2024. What is the maximum duration stipulated by SEBI for the new grievance redressal process to resolve complaints?

- (a) 30 days
- (b) 45 days
- (c) 60 days
- (d) 75 days
- (e) 90 days

Q32. Which of the following statements regarding the e-Shram portal is correctly brought out?

- (a) It was launched by the Ministry of Labour and Employment on 26 August 2020 for the creation of the National Database of Unorganized Workers.
- (b) It was launched by the Ministry of Labour and Employment on 26 August 2021 for the creation of a National Database of only Labour Workers.
- (c) It was launched by the Ministry of Labour and Employment on 26 August 2020 for the creation of the National Database of Organized Workers.
- (d) It was launched by the Ministry of Labour and Employment on 26 August 2021 for the creation of the National Database of Unorganized Workers.
- (e) It was launched by the Ministry of Labour and Employment on 26 August 2021 for the creation of the National Database of Urban Sector Workers.

Q33. PM-PRANAM was first announced in the 2023-24 Budget by the Union government. The scheme aims to reduce the use of chemical fertilizers by incentivizing states to adopt alternative fertilizers. What does the 2nd A stand for in PM-PRANAM?

- (a) Awareness
- (b) Amelioration
- (c) Aware
- (d) Agriculture
- (e) Amalgamation

Q34. The Ministry of Rural Development is implementing the Indira Gandhi National Old Age Pension Scheme (IGNOAPS) under which old age persons of 60 to 79 years belonging to BPL families are provided a pension of ₹ _____ per month. The pension amount is increased to ₹ _____ per month on attaining the age of 80 years.

- (a) 100, 200
- (b) 200, 400
- (c) 200, 500
- (d) 100, 400
- (e) 100, 500

Q35. _____ is a mobile application that provides a citizen-centric platform for locating banking touch points such as bank branches, ATMs, Banking Correspondents (BCs), Indian Post Payment Banks, etc. in the country.

- (a) Jan Dhan Darshak App
- (b) Jan Dhan App
- (c) Know About Bank App
- (d) Apka Bank App
- (e) None of the above

Q36. Who received the 'Changemaker - Social Transformation' award at the Changemaker Awards for their work in improving girls' education in rural areas?

- (a) Neha Bagaria
- (b) Safeena Hussain
- (c) Shrinidhi RS
- (d) Shaktikanta Das
- (e) Both a & b

Q37. The electoral bonds system was introduced in 2017 through a Finance bill and was implemented in 2018. Which denomination is not a multiple of an electoral bond?

- (a) Rs 1,000
- (b) Rs 10,000
- (c) Rs 2,000
- (d) Rs 1 lakh
- (e) Rs 10 lakh

Q38. The Reserve Bank of India (RBI) has apprised that to drive ATM penetration in the country with a greater focus on Tier III to VI centers, non-bank companies have been permitted to set up, own, and operate white-label ATMs (WLAs) in the country. Which of the following facilities are provided by WLAs?

- (i). Account Information
- (ii). Cash Deposit
- (iii). Regular Bill Payment
- (iv). Mini / Short Statement Generation
- (v). PIN Change
- (vi). Request for ChequeBook

- (a) Only (i), (ii) & (iii)
- (b) Only (i) & (iv)
- (c) Only (ii) & (vi)
- (d) Only (iii) & (v)
- (e) All of the above

Q39. What timeframe is given to Credit Institutions (CIs) and Credit Information Companies (CICs) to set up systems for the new compensation framework?

- (a) Three months
- (b) Six months
- (c) One year
- (d) Nine months
- (e) Two months

Q40. In Dec 2023, the government established the Urban Infrastructure Development Fund (UIDF) by utilizing the priority sector lending shortfall. Its purpose is to create urban infrastructure in Tier 2 and Tier 3 cities. Which of the following statements is incorrectly brought out regarding the Urban Infrastructure Development Fund (UIDF)?

- (a) It aims to complement the urban infrastructure development efforts undertaken by State Governments, Public/State Agencies, Municipal Corporations, and Urban Local Bodies.
- (b) The National Housing Bank is responsible for managing the Fund.
- (c) Loans under UIDF are available for activities aligned with the Missions and programs of the Ministry of Housing and Urban Affairs.
- (d) Projects supported by UIDF must meet specific criteria, with a minimum project size of Rs. 5 crores (Rs. 1 crore for North-Eastern and Hilly States) and a maximum size of Rs. 50 crores.
- (e) None of the above

Q41. The Union Housing and Urban Affairs Ministry has mandated the display of the Pradhan Mantri Awas Yojana – Urban (PMAY-U) logo and beneficiary details on all houses constructed under the scheme, applicable to all States and Union Territories, for enhancing transparency and accountability. Which group is defined as families with an annual income up to Rs. 3,00,000 under this scheme?

- (a) Economically Weaker Section (EWS)
- (b) Low-Income Group (LIG)
- (c) Middle-Income Group I (MIG I)
- (d) Middle-Income Group II (MIG II)
- (e) High-Income Group (HIG)

Q42. The Union Cabinet, led by Prime Minister Narendra Modi, has sanctioned an additional _____ for the Interest Equalisation Scheme, extended until _____ to support exporters and MSME manufacturer exporters.

- (a) Rs 1,500 crore; June 30, 2024
- (b) Rs 2,500 crore; June 30, 2024
- (c) Rs 3,500 crore; June 30, 2024
- (d) Rs 2,500 crore; December 31, 2024
- (e) Rs 1,500 crore; December 31, 2024

Q43. Consider the following statements regarding the GOBARdhan Scheme-

(A) GOBARdhan supports the villages in safely managing their cattle waste, agriculture waste, and organic waste in Rural and Urban areas.

(B) The Government of India provides Technical Assistance to every District and financial support of up to ₹50 lakhs per district to achieve safe disposal of cattle and organic waste.

(C) It was launched in 2019 from Karnal, Haryana

Mark the incorrect statements from the above using the codes given below.

- (a) Only A & B
- (b) Only C
- (c) All A, B & C
- (d) Only B & C
- (e) Only A & C

Q44. The Har Ghar Jal Programme, initiated by the Jal Jeevan Mission under the Ministry of Jal Shakti, was unveiled by Prime Minister Shri Narendra Modi on August 15, 2019. This initiative is designed to ensure that every rural household has access to an affordable and consistent supply of safe drinking water through tap connections. This Program is aligned with which of the following SDGs?

- (a) SDG 4
- (b) SDG 5
- (c) SDG 6
- (d) SDG 7
- (e) SDG 8

Q45. The VAIBHAV Fellow would identify an Indian Institution for collaboration and may spend up to two months in a year for a maximum of 3 years. The fellowship would include a grant of Rs. _____ per month, for international and domestic travel, accommodation, and contingencies.

- (a) Rs. 5,00,000
- (b) Rs. 4,00,000
- (c) Rs. 3,00,000
- (d) Rs. 2,00,000
- (e) Rs. 10,00,000

Q46. Which of the following is incorrect about the GDP deflator?

- (a) It measures the changes in prices for all the goods and services produced in an economy.
- (b) It helps economists compare the levels of real economic activity from one year to another.
- (c) $\text{GDP Price Deflator} = (\text{Real GDP} \div \text{Nominal GDP}) \times 100$
- (d) It is a more comprehensive inflation measure than the Consumer Price Index (CPI).
- (e) Changes in consumption patterns or the introduction of new goods and services are automatically reflected in the deflator, but not in the CPI.

Q47. The Commerce and Industry Ministry's LEADS 2023 report identified Andhra Pradesh, Karnataka, Tamil Nadu, Chandigarh, and Gujarat as "achievers" in the logistics index chart for 2023. Which of the following states were labeled as 'aspirers' in the Coastal Group in the LEADS 2023 report?

- (a) Kerala, Goa
- (b) Kerala, Maharashtra
- (c) Goa, Odisha, West Bengal
- (d) Maharashtra, Odisha, West Bengal
- (e) Only West Bengal

Q48. 4E Wave Portal is a dedicated online platform that has been introduced to facilitate interaction among citizens across the nation, enabling information sharing and resources related to energy conservation. It encompasses four core elements. Which of the following is Not among these elements?

- (a) Eco-friendliness
- (b) Economy
- (c) Education
- (d) Energy
- (e) Empowerment

Q49. In December 2023, The Ministry of Health and Family Welfare launched 'MedTech Mitra' to promote the creation of cost-effective and easily accessible domestic medical devices by offering essential support to MedTech innovators in areas such as clinical evaluation, regulatory facilitation, and the adoption of new products. Which organizations have jointly initiated the 'MedTech Mitra' effort?

- (i) NITI Aayog**
- (ii) Indian Council of Medical Research**
- (iii) Central Drugs Standard Control Organisation**

- (a) Only (i) & (ii)
- (b) Only (ii) & (iii)
- (c) Only (i) & (iii)
- (d) All (i), (ii) & (iii)
- (e) None of the above

Q50. The Unique Identification Authority of India (UIDAI), responsible for the implementation of the Aadhaar program, has established a comprehensive regulatory framework to govern the provision of Aadhaar services. This framework encompasses the enrollment and update processes, aiming to maintain transparency and prevent the exploitation of citizens through unauthorized charges. What action has the UIDAI taken against operators guilty of overcharging for Aadhaar services?

- (a) Imposed a penalty of Rs. 5,000
- (b) Imposed a penalty of Rs. 10,000
- (c) Imposed a penalty of Rs. 20,000
- (d) Imposed a penalty of Rs. 30,000
- (e) Imposed a penalty of Rs. 50,000

Q51. Which product from Meghalaya, renowned for its superior quality, was recently awarded the Geographical Indication (GI) tag as announced by Agriculture Minister Ampareen Lyngdoh?

- (a) Meghalaya's Orange
- (b) Lakadong Chilli
- (c) Lakadong Turmeric
- (d) Meghalaya Tea
- (e) Jaintia Rice

Q52. In Dec 2023, what new system has the Ministry of Environment, Forests, and Climate Change implemented to ensure smooth nationwide transportation of forest products such as timber and bamboo?

- (a) National Forest Produce Management System
- (b) Forest Produce Protection System
- (c) National Transit Pass System
- (d) National Forest Produce Transit System
- (e) Forest Transport Management System

Q53. The Fund of Funds for Startups Scheme was approved and established in June 2016 with a corpus of _____, with contributions spread over the 14th and 15th Finance Commission cycle based on the progress of implementation, to provide a much-needed boost to the Indian startup ecosystem and enable access to domestic capital. The Scheme is operationalized by the _____.

- (a) Rs. 5000 crores, Ministry of Finance
- (b) Rs. 10,000 crores, SIDBI
- (c) Rs. 5000 crores, SIDBI
- (d) Rs. 10,000 crores, RBI
- (e) Rs. 15,000 crores, Ministry of Finance

Q54. In December 2023, which regulatory body has recently formed the Dhruva Purkayastha Committee to create a regulatory framework for the promotion of green and sustainable debt securities?

- (a) RBI
- (b) SEBI
- (c) BSE
- (d) NSE
- (e) IFSCA

Q55. Refer to the following statements regarding the Mission Vatsalya Scheme-

(A) Mission Vatsalya Scheme is a roadmap to achieve development and child protection priorities aligned with the Sustainable Development Goals (SDGs).

(B) The Juvenile Justice (Care and Protection of Children) Act, 2016 provisions and the Protection of Children from Sexual Offences Act, 2012 form the basic framework for the implementation of the Mission.

(C) The fund-sharing pattern is in the ratio of 50:50 between Centre and State & Union Territories with Legislature respectively.

Mark the incorrect statements from the above using the codes given below.

- (a) Only A
- (b) Only B & C
- (c) Only A & C
- (d) Only C
- (e) All A, B & C

Q56. The Reserve Bank of India unveiled the eighth edition of its statistical publication, "Handbook of Statistics on Indian States, 2022-23." This publication serves as a comprehensive source for disseminating extensive data on the regional economies within India. Which of the following categories of data is NOT covered in the Handbook of Statistics on Indian States?

- (a) Health
- (b) Agriculture
- (c) International Trade
- (d) Infrastructure
- (e) Banking and fiscal indicators

Q57. What is the revised minimum issue size for public issuance of Zero Coupon Zero Principal Instruments (ZCZP) for NPOs as per SEBI's decision?

- (a) Rs 10 lakh
- (b) Rs 25 lakh
- (c) Rs 50 lakh
- (d) Rs 75 lakh
- (e) Rs 1 crore



BANK MAHAPACK PLUS
For IBPS, SBI, SIDBI, RBI
Grade B, +5 More
Selection Ka Saathi

Q58. Which of the following is/are the pillars under PM Gati Shakti?

- (i). Comprehensiveness
 - (ii). Prioritization
 - (iii). Optimization
 - (iv). Synchronization
 - (v). Analytical
 - (vi). Dynamic
- (a) Only (i), (ii) & (iii)
 - (b) Only (i), (ii) & (iv)
 - (c) Only (ii), (iv) & (vi)
 - (d) Only (iii), (iv) & (v)
 - (e) All of the above

Q59. In Feb 2024, which bank was penalized ₹2 crore by the Reserve Bank of India for breaches concerning shareholding limits and the Depositor Education Awareness Fund Scheme, 2014, under the Banking Regulation Act, 1949?

- (a) HDFC Bank
- (b) ICICI Bank
- (c) Axis Bank
- (d) State Bank of India
- (e) Kotak Mahindra Bank

Q60. The Ministry of Heavy Industries has issued a Gazette Notification to announce the extension of the tenure of the Production Linked Incentive (PLI) Scheme for Automobile and Auto Components by one year. This PLI scheme was launched in _____ with a budgetary outlay of _____. Fill the gaps

- (a) 2018, Rs. 19,650 crores
- (b) 2021, Rs. 25,938 crores
- (c) 2020, Rs. 23,793 crores
- (d) 2017, Rs. 26,224 crores
- (e) 2019, Rs. 19,987 crores

Q61. In January 2024, The Ministry of AYUSH initiated which program to foster extensive clinical research in key areas of Ayurveda, involving collaboration with Ayurveda academic institutions and hospitals nationwide.

- (a) SMART 2.0
- (b) AYURVEDA
- (c) AYUSH
- (d) AAROGYA
- (e) MEDICARE

Q62. In January 2024, A significant milestone has been crossed by the Health Ministry. More than 1 crore people have been screened for Sickle Cell Disease under the National Sickle Cell Anaemia Elimination Mission. Sickle cell disease is a genetic blood disease that affects the whole life of a patient. The government aims to eliminate sickle cell genetic transmission by the year-

- (a) 2025
- (b) 2030
- (c) 2037
- (d) 2040
- (e) 2047

Q63. The National Highways Authority of India (NHAI) has collaborated with which organization to develop and report a "Green Cover Index" for the National Highways network in India?

- (a) Defence Research and Development Organisation (DRDO)
- (b) Indian Council of Agricultural Research (ICAR)
- (c) National Remote Sensing Centre (NRSC)
- (d) Central Road Research Institute (CRRI)
- (e) Indian Institute of Science (IISc)

Q64. Recently (January 2024), Where has India's first all-girls 'Samvid Gurukulam Girls Sainik School' been inaugurated?

- (a) Vrindavan
- (b) Udaipur
- (c) Patiala
- (d) Mathura
- (e) Patna

Q65. In January 2024, the Department of School Education & Literacy, Ministry of Education, Government of India launched 'Prerana: An Experiential Learning program', aiming to offer a meaningful, unique, and inspiring experience to all participants, thereby empowering them with leadership qualities. Identify the correct statement regarding the program-

- (a) It aims to offer a meaningful, unique, and inspiring experience to all participants, thereby empowering them with leadership qualities.
- (b) It is a week-long residential program for selected students of class IX to XII.
- (c) The curriculum of Prerana School prepared by IIT Gandhi Nagar is rooted in nine value-based themes
- (d) It will run from a Vernacular School, established in 1888, in one of the oldest living cities of India, Vadnagar, district Mehsana, Gujarat.
- (e) All are correct

Q66. How often does the Reserve Bank of India (RBI) publish the Financial Stability Report (FSR)?

- (a) Annually
- (b) Biannually
- (c) Quarterly
- (d) Monthly
- (e) Every three years

Q67. As of September 2023, what was the Gross Non-Performing Assets (GNPA) ratio of Scheduled Commercial Banks (SCBs) in India?

- (a) 1.5%
- (b) 2.1%
- (c) 3.2%
- (d) 4.6%
- (e) 5.3%

Q68. In January 2024, The Union Cabinet recently approved the comprehensive scheme "PRITHvi Vigyan (PRITHVI)" by the Ministry of Earth Sciences to develop modeling systems for understanding and predicting weather, ocean, and climate hazards and understanding the science of climate change. This initiative spans five sub-schemes, which of the following is NOT among them

- (a) Atmosphere & Climate Research-Modelling Observing Systems & Services (ACROSS)
- (b) Ocean Services, Modelling Application, Resources and Technology (O-SMART)
- (c) Polar Science and Cryosphere Research (PACER)
- (d) Research and Training Earth's surface (RATE)
- (e) Seismology and Geosciences (SAGE)

Q69. In January 2024, The Ministry of Environment, Forests and Climate Change for the first time submitted three nominations from India for Wetland City Accreditation (WCA) under the Ramsar Convention on Wetlands. Which of the following are nominated cities for WCA from India?

- (i). Jaipur
- (ii). Varanasi
- (iii). Vrindavan
- (iv). Indore
- (v). Bhopal
- (vi). Udaipur

- (a) Only (i), (ii) & (iii)
- (b) Only (i), (ii) & (iv)
- (c) Only (ii), (iv) & (vi)
- (d) Only (iii), (iv) & (v)
- (e) Only (iv), (v) & (vi)

Q70. The Reserve Bank introduced the framework for Domestic Systemically Important Banks (D-SIBs) on July 22, 2014. Banks designated as D-SIBs are identified and disclosed annually. How has the D-SIB assessment methodology revised the 'Payments' sub-indicator?

- (a) 50% weightage on the total value and 50% on the total volume of Digital Payments
- (b) 100% weightage on the total value of Digital Payments
- (c) 75% weightage on the total value and 25% on the total volume of Digital Payments
- (d) 25% weightage on the total value and 75% on the total volume of Digital Payments
- (e) Equal weightage on total value and volume of all types of Payments

Q71. Consider the following statements regarding the New Swarnima Scheme for Women and Identify which of the following is incorrect.

- (a) It primarily targets women from Backward Classes with an annual family income of less than Rs. 3.00 Lakh.
- (b) Beneficiary women are not required to make any personal investment for projects up to a cost of Rs. 2,00,000/-.
- (c) The financing pattern for the loans provided under the scheme is divided as follows: 95% of the loan amount is provided by NBCFDC (National Backward Classes Finance & Development Corporation), while the remaining 5% is contributed by a Channel Partner.
- (d) The loan given under the scheme is to be repaid in quarterly installments over a maximum period of 8 years, including a six-month moratorium on principal recovery.
- (e) None of the above

Q72. As of now, which States/Union Territories have successfully attained 100% coverage in providing tap water connections to rural households under the Jal Jeevan Mission (JJM), which commenced in 2019 and has already extended these connections to 14 Crore (72.71%) rural households?

- (i). Goa
 - (ii). Telangana
 - (iii). Haryana
 - (iv). Gujarat
 - (v). Punjab
 - (vi). Himachal Pradesh
- (a) Only (i), (ii) & (iii)
 - (b) Only (i), (ii) & (iv)
 - (c) Only (ii), (iv) & (vi)
 - (d) Only (iii), (iv) & (v)
 - (e) All of the above

Q73. The Reserve Bank of India (RBI) recently allowed which category of non-bank financial companies (NBFCs) to use credit risk transfer instruments for exposure calculation?

- (a) Upper-layer NBFCs
- (b) Middle-layer NBFCs (NBFC-ML)
- (c) Base-layer NBFCs
- (d) Government NBFCs
- (e) Foreign NBFCs

Q74. Which type of exposures are now exempt from credit concentration norms under the new RBI guidelines for NBFCs?

- (a) Exposures to private corporations
- (b) Exposures fully guaranteed by the Government of India
- (c) International exposures
- (d) Exposures to non-profit organizations
- (e) Exposures to start-up companies

Q75. The Ministry of Sports and Youth Affairs implements the scheme of 'Pandit Deendayal Upadhyay National Welfare Fund for Sportspersons' (PDUNWFS) to provide suitable assistance to outstanding sportspersons. Financial assistance up to _____ for outstanding sportspersons living in indigent circumstances and up to _____ for medical treatment to sportspersons or family members is provided under the scheme of PDUNWFS.

- (a) Rs. 1 Lakh, Rs. 6 Lakh
- (b) Rs. 2 Lakh, Rs. 7 Lakh
- (c) Rs. 3 Lakh, Rs. 8 Lakh
- (d) Rs. 4 Lakh, Rs. 9 Lakh
- (e) Rs. 5 Lakh, Rs. 10 Lakh

Q76. Which scheme was recently honored with the Best Innovation Award for Innovation Sandbox Presentation at the Public Policy Dialogue-2024 hosted by the Indian School of Business, Hyderabad?

- (a) Pradhan Mantri Awas Yojana
- (b) Swachh Bharat Mission
- (c) SVAMITVA Scheme
- (d) National Digital Health Mission
- (e) Atal Innovation Mission

Q77. In Feb 2024, The Insurance Regulatory and Development Authority of India (IRDAI) revealed the formation of a new Expert Committee for the execution of Ind AS/IFRS. This committee, led by the IRDAI Member (Finance and Investment) F&I, is composed of _____ members.

- (a) 9 members
- (b) 10 members
- (c) 11 members
- (d) 13 members
- (e) 15 members

Q78. What was the theme of the Swachh Survekshan 2023, the largest urban sanitation and cleanliness survey in the world?

- (a) Clean and Green Cities
- (b) Waste to Wealth
- (c) Urban Sanitation for All
- (d) Sustainable Urban Development
- (e) Healthy Cities, Healthy Nation

Q79. What is the term used to denote the price, ratio, or value at which one currency is exchanged for another currency?

- (a) Currency Connotation
- (b) Exchange Quotient
- (c) Currency Parity
- (d) Exchange Rate
- (e) Currency Equivalence

Q80. Consider the following statements regarding Atal Pension Yojana-

(A) The scheme was launched on 9th May 2016 by Prime Minister Shri Narendra Modi with the objective of delivering old-age income security to all citizens of India, particularly to the workers in the unorganized sector.

(B) Under APY, a subscriber would receive a lifelong minimum guaranteed pension of Rs.1000 to Rs.5000 per month from the age of 60 years, depending on their contributions.

(C) New APY account can be opened by any Indian citizen, in the age group of 18-40 years, who has a savings bank account and who is not an income taxpayer.

Mark the incorrect statements from the above using the codes given below.

- (a) All A, B & C
- (b) Only A & B
- (c) Only C
- (d) All A, B & C are correct
- (e) Only A

Directions (81-89): Read the given passage and answer the questions based on it.

Individuals with ADHD face academic struggles due to deficit in executive functioning. While comprehension difficulties in reading and listening are associated with ADHD, their **specific** nature is not well understood.

People with ADHD who also have difficulty decoding words are more likely to struggle with reading comprehension. These difficulties in identifying written words can impede overall comprehension, making it challenging to determine whether the issues lie in decoding, comprehension, or both. Consequently, studies have often turned to listening comprehension as a means to investigate comprehension deficits associated with ADHD.

Research on listening comprehension in individuals with ADHD reveals difficulties in higher-order language processes, including understanding figurative language and answering inferential questions. Individuals with ADHD demonstrate deficits in organization and **coherence** when asked to retell information they have heard, in comparison to their peers.

During comprehension tasks, individuals construct a mental representation of a passage by forming connections among the ideas presented. Central ideas, those with the most connections to other ideas in the passage, emerge as crucial to understanding the overall message. On the other hand, peripheral ideas have fewer connections and are considered less important. By forming appropriate connections, a coherent representation of the text is **established**.

In conclusion, children with ADHD often experience a centrality deficit in listening comprehension due to the transient nature of auditory information. This, coupled with decoding deficits in reading and challenges in higher-order language processes and organization in listening, _____ to their academic struggles. Understanding these difficulties can guide the development of interventions and support strategies to enhance comprehension skills and academic performance in individuals with ADHD.

Q81. What is one significant factor contributing to reading comprehension difficulties in individuals with ADHD?

- (a) Word decoding deficits can hinder reading fluency and comprehension in individuals with ADHD.
- (b) Lack of interest in reading can negatively impact reading comprehension in individuals with ADHD.
- (c) Impaired vision can affect reading and comprehension abilities in individuals with ADHD.
- (d) Limited vocabulary can pose challenges for reading and understanding text in individuals with ADHD.
- (e) Excessive attention to details may impede overall comprehension in individuals with ADHD.

Q82. How does ADHD contribute to the academic struggles of the individual?

- (a) It includes a chronic problem in which people lack the ability to maintain self-control
- (b) It involves a dysfunction that disrupt the brain's ability to control thoughts and behavior
- (c) It comprises the inability to sleep with a balanced circadian cycle.
- (d) It involves procrastination which can lead to negative mood and emotions.
- (e) It includes the inability to understand and adapt the social behaviour during an interaction.

Q83. What is the role of central ideas in understanding the overall message of a passage, compared to peripheral ideas?

- (a) Central ideas have more connections to other ideas and are crucial to understanding the overall message, while peripheral ideas have fewer connections and are considered less important.
- (b) Central ideas have fewer connections to other ideas and are considered less important, while peripheral ideas have more connections and are crucial to understanding the overall message.
- (c) Central ideas and peripheral ideas have equal importance in understanding the overall message of a passage.
- (d) Central ideas and peripheral ideas have no impact on understanding the overall message of a passage.
- (e) The importance of central ideas and peripheral ideas varies depending on the specific passage being read.

Q84. How does the transient nature of auditory information pose challenges for individuals with ADHD?

- (a) Individuals with ADHD often experience difficulty sustaining attention, which can significantly impact their academic performance.
- (b) Individuals with ADHD may exhibit a range of learning preferences, and being more visually-oriented learners is one possible trait.
- (c) Some individuals with ADHD may struggle with reading comprehension due to their critical state of short-term memory.
- (d) Conduct disorder is typically associated with ADHD as it primarily involves difficulties in attention and impulse control.
- (e) Some individuals with ADHD may show a preference for visual stimuli over auditory stimuli, which may influence their learning style and engagement.

Q85. What are some of the challenges that individuals with ADHD face when retelling information, they have heard?

- (a) Individuals with ADHD may struggle with recalling information accurately.
- (b) Individuals with ADHD manifest challenges with spelling.
- (c) Inability to identify and manipulate the sounds in spoken language.
- (d) Individuals with ADHD stumble over words while reciting the information of the comprehension
- (e) Individuals with ADHD has limited conversational and social skills.

Q86. Which of the following is the synonym of the word “specific” highlighted in the passage?

- (a) general
- (b) typical
- (c) rumple
- (d) explicit
- (e) disarray

Q87. Which of the following is the antonym of the word “coherence” highlighted in the passage?

- (a) suspends
- (b) banishes
- (c) excludes
- (d) prevents
- (e) tension

Q88. Which of the following fits appropriately in the blank highlighted in the passage?

- (a) stings
- (b) spares
- (c) leverage
- (d) contributes
- (e) correlates

Q89. Which of the following is the synonym of the word “established” highlighted in the passage?

- (a) collection
- (b) determinate
- (c) dissipation
- (d) concentration
- (e) None of the above

Directions (90-93): In each of the questions, a word is omitted, which is replaced by a blank. Choose the most appropriate option of the word that can fit into the given blank at the same order so to make a grammatically and logically correct statement.

Q90. After breaking her ankle, Angie had to attend therapy to _____ and repair it.

- (a) strengthen
- (b) ensure
- (c) condition
- (d) initial
- (e) liberal

Q91. The pregnant woman had a constant _____ for pickles and ice cream.

- (a) composition
- (b) fettle
- (c) craving
- (d) voyage
- (e) wander

Q92. The poet was frustrated that so many of the readers were confused and _____ the meaning of her latest piece.

- (a) reinforce
- (b) fortify
- (c) anneal
- (d) misconceived
- (e) inure

Q93. The mobile game calls upon users to _____ balls by colour in order to save baby pandas.

- (a) preserved
- (b) aggregate
- (c) scant
- (d) disastrous
- (e) inferior

Directions (94-98): In each of the following questions, two meaningful sentences are given. Following the sentences, five options have been given. Find out which of the following options can be used to connect the sentences without altering the intended meaning.

Q94. (I) The tantalizing aroma of street food wafts

(II) the air, enticing hungry wanderers

- (a) through
- (b) until
- (c) on
- (d) to
- (e) beside

Q95. (I) The serving trays in her grandmother's kitchen seemed indestructible

(II) they had made it through decades of family dinners.

- (a) through
- (b) as
- (c) on the other hand
- (d) along
- (e) while

Q96. (I) Fred was indistinguishable to his classmates

(II) his twin brother was standing next to him

- (a) along
- (b) to
- (c) until
- (d) since
- (e) besides

Q97. (I) The contract includes a clause outlining the conditions

(II) which the agreement can be terminated

- (a) to
- (b) along
- (c) through
- (d) that
- (e) under

- Q98.** (I) The company's quality control measures ensure
(II) all products meet industry standards
(a) since
(b) whereas
(c) that
(d) from
(e) to

Directions (99-100): In the following questions, sentences are given with four words in bold. The given words in bold may or may not be correctly spelt. The incorrectly spelt word will be your answer. If all the words are correct then select 'All are correct' as your answer.

- Q99.** **Conspiring** with others to **commit** a crime is **illegal** and can result in serious **consequencses**.
(a) conspiring
(b) illegal
(c) consequencses
(d) commit
(e) None of the above

- Q100.** When I **watch** my cat and dog play **together**, it's **comforting** to know animals of different **species** can coexist.
(a) watch
(b) together
(c) comforting
(d) species
(e) None of the above

Directions (101-105): In each of the questions given below four words are given in bold. These words may or may not be in their correct position. Following each sentence four sequences are provided. Select the sequence of the words which will make the given sentence contextually meaningful. If the words are correct at their current position, then choose 'no rearrangement required' as your answer.

- Q101.** With **unwavering(A)** determination, she **refusing (B)** her dreams, **pursued (C)** to give up **despite(D)** the challenges.
(a) ACBD
(b) CBAD
(c) DCBA
(d) BDAC
(e) No rearrangement required

- Q102.** The **express (A)** notes of the piano **melodious (B)** in the air, **evoking(C)** emotions that words could never **danced(D)**.
(a) CDBA
(b) BCAD
(c) BDCA
(d) CBAD
(e) No rearrangement required

- Q103.** In the **whispered (A)** meadow, the soft breeze **peace (B)** through the tall grass, creating a **serene (C)** symphony of nature's **tranquil (D)**.
(a) DABC
(b) ACDB
(c) ABDC
(d) CADB
(e) No rearrangement required

Q104. The detective **uncovered(A)** a web of **intrigue(B)** and mystery, each clue leading them **crime (C)** to the truth behind the **closer (D)**.

- (a) CDAB
- (b) ABDC
- (c) BDAC
- (d) DCBA
- (e) No rearrangement required

Q105. The **night(A)** sky was **aglow(B)** with countless stars, their **luminous(C)** brilliance casting a **magical(D)** spell on the Earth below.

- (a) ACDB
- (b) BCAD
- (c) CBDA
- (d) DACB
- (e) No rearrangement required

Directions (106-110): Five coherent statements are given. Rearrange those in a meaningful order and answer the questions following to that.

- (A) It not only affects physical performance but also impacts mental acuity and overall well-being.
- (B) Without prompt intervention, severe dehydration can lead to organ failure and even be life-threatening.
- (C) Dehydration can manifest through various symptoms such as dry mouth, thirst, dizziness, fatigue, and dark-coloured urine.
- (D) Dehydration is a critical condition resulting from an inadequate intake of fluids or excessive loss of water from the body.
- (E) It occurs when the body's water levels drop below the required amount for optimal function.

Q106. Which of the following will be the **second** statement after rearrangement?

- (a) A
- (b) C
- (c) D
- (d) B
- (e) E

Q107. Which of the following will be the **first** statement after rearrangement?

- (a) B
- (b) D
- (c) E
- (d) C
- (e) A

Q108. Which of the following will be the **fourth** statement after rearrangement?

- (a) D
- (b) C
- (c) A
- (d) E
- (e) B

Q109. Which of the following will be the **fifth** statement after rearrangement?

- (a) E
- (b) B
- (c) C
- (d) D
- (e) A

Q110. Which of the following will be the **final sequence** of the statements after rearrangement?

- (a) ACDBE
- (b) CDBEA
- (c) BDEAC
- (d) DECAB
- (e) EBDCA

Q111. A milkman has 160 liters pure milk and he mixes a certain quantity of water (in liter) in it and make profit of 25% by selling the mixture at milk cost price. If cost price of pure milk was Rs. 48 per liter and shopkeeper mixed 'Q' liters of water in the 160 liters of pure milk, then find value of (Q + 8)?

- (a) 36
- (b) 50
- (c) 48
- (d) 40
- (e) 52

Q112. Anchal borrowed Rs. 8000 from Khushi on compound interest at rate of 20% p.a. for two years and she added some extra amount and lent it to Ankit on compound interest at rate of 10% p.a. for two years. If Anchal received Rs.3410 more interest than interest received by Khushi, then find the extra amount added by Anchal.

- (a) Rs. 15000
- (b) Rs. 10000
- (c) Rs. 12000
- (d) Rs. 25000
- (e) Rs. 28000

Q113. A man spends Rs.28000 in August, which is 20%, less than the amount spend by him in May. Total expenditure in May is 40% more than that of in July. If the ratio of amount spend in month of June to July is 4 :5, then find the difference between average expenditure in month of June & August together and average expenditure in month of May & July together.

- (a) Rs.2600
- (b) Rs.5100
- (c) Rs.7800
- (d) Rs.6000
- (e) Rs.4500

Q114. A can complete $\frac{1}{8}$ th of a work in $\frac{2}{3}$ days, B complete $\frac{1}{3}$ rd of the work in 4 days and C complete $\frac{1}{6}$ th of the work in $\frac{5}{3}$ days. If all three together started the work and after 1.5 days A and B left the work while C works for Y days. After Y days, C also left the work and B joins again & complete the remaining work in $\frac{69}{40}$ days. Find the value of Y.

- (a) 7
- (b) 3
- (c) 5
- (d) 9
- (e) 11

Q115. A, B and C entered into partnership. The amount invested by B is $\frac{3}{5}$ th of amount invested by C and the amount invested by A is half of amount invested by B. After eight months, each A, B and C withdrew Rs. r. At the end of a year, the ratio of profit share of A to total profit is 1:10. Find the ratio of profit share of B to that of C.

- (a) 31:59
- (b) 13:95
- (c) 13:23
- (d) 31 :37
- (e) 51:29

Directions (116-120): The line graph given below shows total number (in hundred) of two different newspapers published by a publisher in five different months and percentage of ET published out of total newspapers published. In these five months Read data carefully and answer the following questions.

Note: Total newspaper published in any month = Total (TOI + ET) published

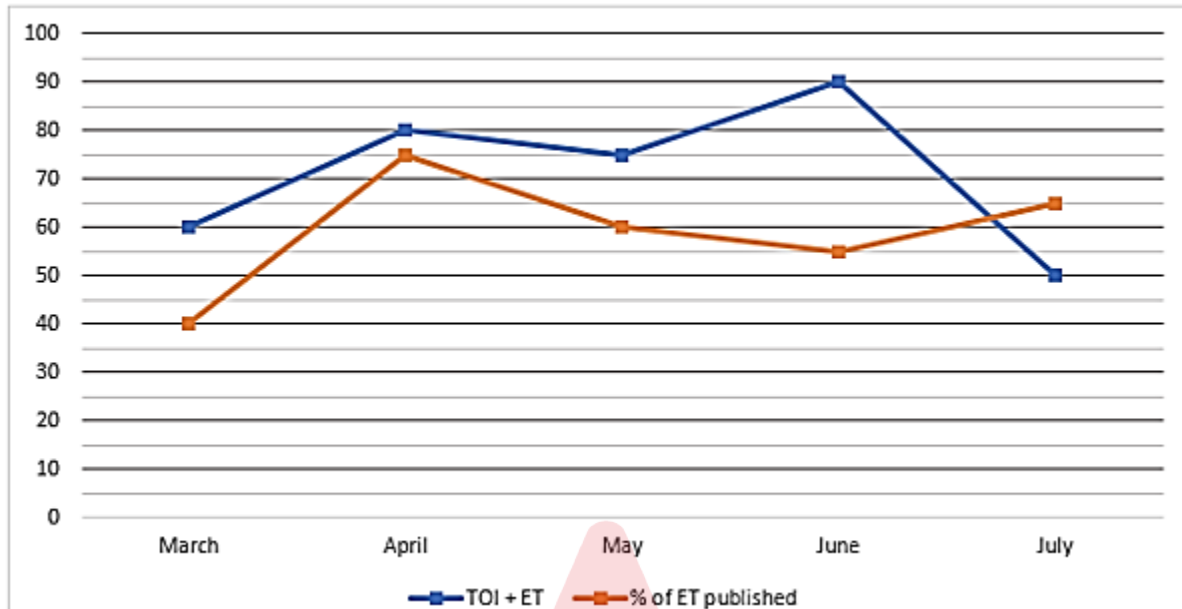

Q116. Total ET published by publisher in May and June together is what percent more than total TOI published by publisher in March?

- (a) 162.5%
- (b) 160.25%
- (c) 164.25%
- (d) 158.25%
- (e) 166.25%

Q117. Find the average number of TOI published by publisher in March, May and June?

- (a) 3250
- (b) 3750
- (c) 3500
- (d) 3550
- (e) 3600

Q118. If total TOI published by publisher in August is half of the total newspapers (TOI + ET) published by publisher in April and ratio of TOI to ET published in August is 5 : 3, then total ET published by publisher in August is how much less than total TOI published in May?

- (a) 800
- (b) 400
- (c) 600
- (d) 200
- (e) 500

Q119. If total TOI published by publisher in June is sold at the profit of 25% and selling price of each newspaper is Rs 35, then find the total cost price of all the TOI which is sold by publisher in June (in Rs.) (Publisher sold all TOI newspapers in June)?

- (a) 1,13,600
- (b) 1,14,200
- (c) 1,14,800
- (d) 1,13,200
- (e) 1,13,400

Q120. Find the ratio of total TOI published by publisher in April and July together to total ET published by publisher in June?

- (a) 25 : 29
- (b) 25 : 27
- (c) 25 : 31
- (d) 25 : 33
- (e) 25 : 36

Directions (121-123): The radar graph given below shows the percentage distribution of revenue obtained by selling three articles i.e. Pen, Pencil and Eraser by three different shops P, Q and R. Study the radar charts carefully and answer the following questions.

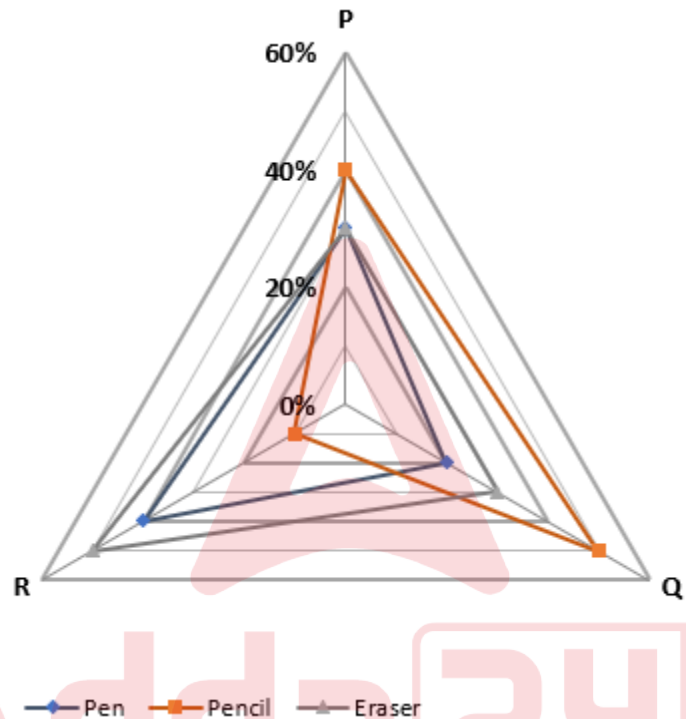

Q121. If total cost of three articles for store Q is twice than that of store R and profit percent for store Q and R is same, then find the ratio of revenue obtained by shop Q in selling pencil to the revenue obtained by shop R in selling eraser.

- (a) 5 : 2
- (b) 2 : 3
- (c) 3 : 2
- (d) 1 : 2
- (e) 2 : 1

Q122. Total revenue obtained for shop P in selling pen is 20% more than revenue obtained by selling eraser for shop Q and 20% less than revenue obtained from selling pens for shop R. Total revenue obtained for shop Q is what percent of total revenue obtained for shop R.

- (a) $88\frac{8}{9}\%$
- (b) $72\frac{5}{9}\%$
- (c) 75%
- (d) $62\frac{1}{2}\%$
- (e) 87.5%

Q123. Number of pencils sold by shop P is 'm' and number of erasers sold by shop R is 120% of m. If selling price per unit of pencil by shop P and that of eraser by shop R is same, then total revenue obtained by shop P is what percent of total revenue obtained by shop R.

- (a) 110%
- (b) $106\frac{5}{6}\%$
- (c) 105%
- (d) 102%
- (e) $104\frac{1}{6}\%$

Directions (124-125): In the following questions, series (I) is given in which one term is wrong with which another series (II) started. You have to find the wrong term in series (I) then starting from that, find what will come in the place of question(?) mark term in new series (II) which formed at same pattern of series (I).

Q124. (I) 210, 232, 270, 350, 510, 830, 1470

(II) _____, _____, _____, _____, _____, _____, ?

- (a) 1210
- (b) 1470
- (c) 1270
- (d) 1492
- (e) 1830

Q125. (I) 48, 144, 360, 720, 1040, 1080, 540

(II) _____, _____, ?, _____, _____, _____, _____

- (a) 7800
- (b) 7040
- (c) 7080
- (d) 7020
- (e) 7060

Directions (126-130): The given bar graph shows the average number of movies (Bollywood and Hollywood) released in five different years and also shows the difference between movies released of Bollywood and Hollywood in given years. Read the data carefully and answer the following questions based on it.

Note: Bollywood movie released are more than Hollywood movies in all given years.

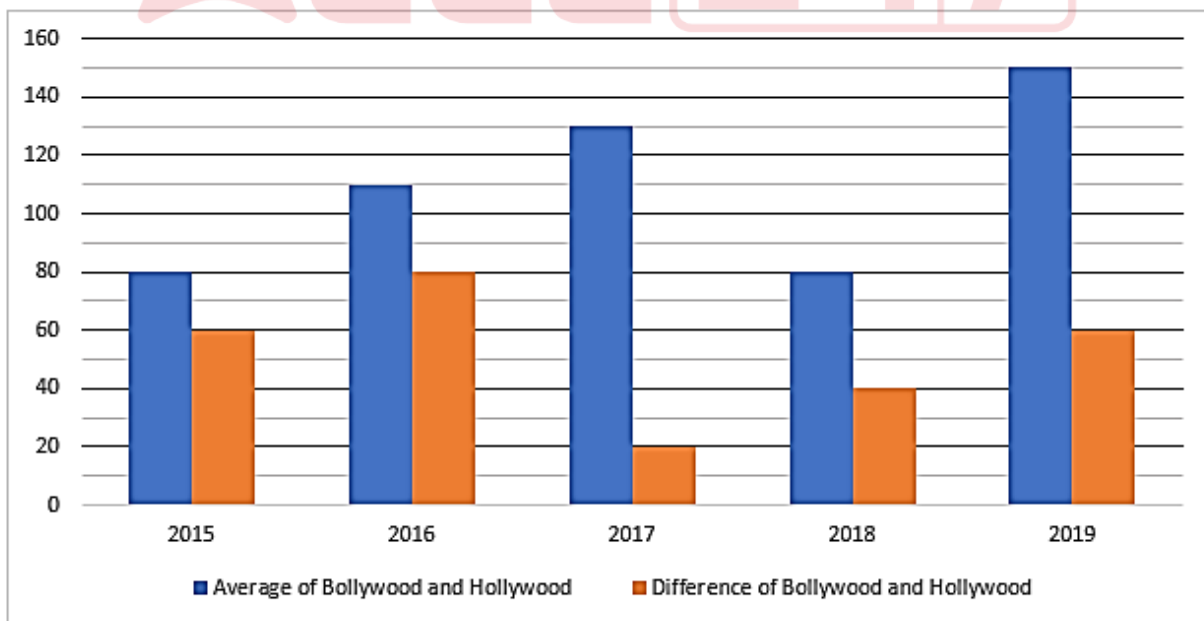

Q126. Total Hollywood movies released in 2017 is what percentage more or less than total Bollywood movies released in 2019?

- (a) $33\frac{1}{3}\%$
- (b) 25%
- (c) 50%
- (d) 40%
- (e) 20%

Q127. Total number of Bollywood movies released in 2016 and 2017 together are how much more or less total movies released in 2015 and 2016 together.

- (a) 120
- (b) 90
- (c) 60
- (d) 100
- (e) 130

Q128. What is the respective ratio of average number of Bollywood movie released in all the given years to average number of Hollywood movies released in given years?

- (a) 17:14
- (b) 34: 21
- (c) 29: 21
- (d) 31: 23
- (e) 34: 25

Q129. In 2020, total movies (Bollywood +Hollywood) released are decrease by 40% than the previous year while Bollywood movies are $100/7\%$ more than Hollywood movies released. Find total Hollywood movies released in 2020.

- (a) 96
- (b) 84
- (c) 72
- (d) 104
- (e) 112

Q130. If total movies (Bollywood +Hollywood +Tollywood) in 2018 are 215 and ratio of Tollywood movies released in 2018 and 2019 is 11: 14, then find total number of movies (Bollywood + Hollywood +Tollywood) released in 2019.

- (a) 390
- (b) 410
- (c) 430
- (d) 370
- (e) 350

Q131. The time taken by boat P to travel 260 km in downstream is equal to the time taken by it to travel 220 km in upstream. If the ratio of the speed of boat Q in still water and speed of current is same as that for boat P such that downstream speed of boat Q is 39 km/hr, then find the time taken by boat Q to travel 462 km upstream.

- (a) 10 hours
- (b) 14 hours
- (c) 4.5 hours
- (d) 12.6 hours
- (e) 8 hours

Q132. The selling price of an article is 20% less than its marked price and the profit earned on selling the article is 25%. If the difference between, discount and the difference between cost price & marked price is Rs 128, then find at what price article should be sell to make a profit of $25/4\%$?

- (a) Rs 670
- (b) Rs 1090
- (c) Rs 445
- (d) Rs 544
- (e) Rs 764

Q133. A mixture contains liquids A and B in which liquid B is 37.5% more than that of liquid A. If 57 liters of mixture is taken out and replaced with another liquid C, then concentration of liquid A in the final mixture become 40%. Find the quantity of liquid B in the final mixture.

- (a) 484 liters
- (b) 527 liters
- (c) 612 liters
- (d) 627 liters
- (e) 207 liters

Directions (134-135): Read the given data carefully and answer the questions:

Average number of female employees working in HCL and IBM is 420 and total number of male employees in both the companies are 1620. Number of female employees is $\frac{2}{3}$ of male employee and number of female employees is $\frac{2}{5}$ of number of male employees in HCL and IBM respectively.

Q134. Out of total female employee working in HCL, the ratio between MBA degree holder to B. tech degree holder is 7 : 5. Find MBA degree holder female employee are what percent of total employee working in HCL.

- (a) $20\frac{1}{3}\%$
- (b) $19\frac{1}{3}\%$
- (c) $27\frac{1}{3}\%$
- (d) $25\frac{1}{3}\%$
- (e) $23\frac{1}{3}\%$

Q135. Find the ratio between total female employee working in IBM to total male employee working in HCL.

- (a) 2 : 1
- (b) 3 : 1
- (c) 1: 3
- (d) 1: 2
- (e) 2 : 3

Directions (136-137): In the following questions two quantities are given for each question. Compare the numeric value of both the quantities and answers accordingly.

Q136. Quantity I: Time taken by A to do the work alone. A and B together can complete a work in 12 day, while efficiency of B is 200% more than A.

Quantity II: Time taken by 8 men to complete the work. two men can do $\frac{1}{2}$ of work in 96 days

- (a) Quantity I > Quantity II
- (b) Quantity II > Quantity I
- (c) Quantity I \geq Quantity II
- (d) Quantity II \geq Quantity I
- (e) Quantity I = Quantity II or relation can't be established.

Q137. Quantity I: Value of 'X'. the time taken by a boat to cover 'X' in downstream and 'X-5' in upstream is in the ratio of 3:4. If downstream speed is 5 kmph more than the upstream and speed of boat in still water is $12\frac{1}{2}$ kmph.

Quantity II: 40

- (a) Quantity I > Quantity II
- (b) Quantity II > Quantity I
- (c) Quantity I \geq Quantity II
- (d) Quantity II \geq Quantity I
- (e) Quantity I = Quantity II or relation can't be established.

Directions (138-140): The following questions are accompanied by two statements I and II. You have to determine which statement(s) is/are sufficient/necessary to answer the questions.

Q138. Find the two-digit number?

I. Sum of the digits of the number is 25% of the number.

II. Thrice of the number is 30 more than the number obtained on interchanging the digits.

- (a) Statement I alone is sufficient to answer the question but statement II alone is not sufficient to answer the questions.
- (b) Statement II alone is sufficient to answer the question but statement I alone is not sufficient to answer the question.
- (c) Both the statements taken together are necessary to answer the questions, but neither of the statements alone is sufficient to answer the question.
- (d) Either statement I or statement II by itself is sufficient to answer the question.
- (e) Statements I and II taken together are not sufficient to answer the question.

Q139. What is the selling price of an article if the ratio of marked price to that of the cost price of the article is 8: 5?

I. On article, first discount of 20% and then discount of 10% is given and difference between these discounts is Rs 192.

II. Difference between marked price and the cost price of that article is Rs 600 and the profit percent earned on selling the article is 15.2%.

- (a) Statement I alone is sufficient to answer the question but statement II alone is not sufficient to answer the questions.
- (b) Statement II alone is sufficient to answer the question but statement I alone is not sufficient to answer the question.
- (c) Both the statements taken together are necessary to answer the questions, but neither of the statements alone is sufficient to answer the question.
- (d) Either statement I or statement II by itself is sufficient to answer the question.
- (e) Statements I and II taken together are not sufficient to answer the question.

Q140.

Find the value of $\frac{64^{2a}}{4^b 16^{2b}} = ?$

I. $6a - 5b = 8$

II. $a = 3$ and $b = 14 - 4a$

- (a) Statement I alone is sufficient to answer the question but statement II alone is not sufficient to answer the questions.
- (b) Statement II alone is sufficient to answer the question but statement I alone is not sufficient to answer the question.
- (c) Either statement I or statement II by itself is sufficient to answer the question.
- (d) Both the statements taken together are necessary to answer the questions, but neither of the statements alone is sufficient to answer the question.
- (e) Statements I and II taken together are not sufficient to answer the question.

Directions (141-145): Study the following information carefully and answer the below questions.

Ten persons- Q, R, S, T, U, V, W, X, Y and Z are working in a company on different designations. The designations of the people are in decreasing order as follows - Chairman, MD, CEO, COO, CFO, CAO, CIO, CTO, CMO and CHRO, where Chairman is the senior-most designated person and CHRO is the junior-most designated person.

R works three positions senior to the one who is immediately junior to S. More than four persons are senior to R. Only three persons are designated between R and W. The number of persons senior to W is the same as the number of persons junior to Y. Q is immediately junior to the one who works four positions senior to V. Q neither works as Chairman nor CIO. The number of persons designated between Q and R is the same as the number of persons designated between S and Z. X is senior to U but not senior to T. U is designated as neither CMO nor CHRO.

Q141. Which of the following statement(s) is/are true with respect to the final arrangement?

I. R is designated as CAO

II. Only two persons are designated between W and U

III. V is immediately junior to S

- (a) Only I
- (b) Only I and III
- (c) Only II
- (d) Only I and II
- (e) All I, II and III

Q142. Who among the following person works as COO?

- (a) Q
- (b) T
- (c) V
- (d) S
- (e) W

Q143. Four of the following five are alike in a certain way as per the given arrangement and thus form a group. Which one of the following does not belong to that group?

- (a) TX
- (b) WQ
- (c) UV
- (d) SZ
- (e) YT

Q144. How many persons are senior to U?

- (a) Three
- (b) Two
- (c) One
- (d) Four
- (e) None

Q145. In which of the following designation does S work?

- (a) Chairman
- (b) CEO
- (c) CTO
- (d) CMO
- (e) CFO

Q146. How many such pairs of letters are there in the word "NEWSPAPER" (forward direction only) each of which has as any letters between them as in the English alphabetical series?

- (a) One
- (b) Two
- (c) Three
- (d) More than three
- (e) None

Directions (147-151): Study the following information carefully and answer the questions given below.

Six persons- A, B, C, D, E and F are sitting around a circular table facing the center. They read different newspapers- Amar Ujala, Hari Bhoomi, NBT, Mint, Jansatta, and HT. but not necessarily in the same order.

C sits second to the left of the one who reads Hari Bhoomi. A neither sits opposite to C nor to the one who reads Hari Bhoomi. A does not read Hari Bhoomi but sits adjacent to D. The one who reads Amar Ujala sits second to the right of D. B sits second to the right of E. The one who reads Mint sits second to the left of F. The one who reads Jansatta sits immediate right of the one who reads NBT. B does not read NBT. The one who reads NBT does not sit opposite to the one who reads Amar Ujala.

Q147. Who among the following person sits opposite to the one who reads Hari Bhoomi?

- (a) D
- (b) B
- (c) E
- (d) None of these
- (e) F



Q148. Who among the following person sits third to the right of the one who reads NBT?

- (a) B
- (b) E
- (c) D
- (d) C
- (e) None of the above

Q149. If all the persons are sitting in the alphabetical order from A in an anti-clockwise direction, then how many persons are unchanged in their positions (excluding A)?

- (a) More than three
- (b) None
- (c) Three
- (d) Two
- (e) One

Q150. Which of the following newspaper is read by D?

- (a) HT
- (b) Hari Bhoomi
- (c) NBT
- (d) Mint
- (e) None of these

Q151. Which of the following statement(s) is/are true based on the given arrangement?

- I. C and D are sitting opposite to each other
- II. A sits immediate right of the one who reads NBT
- III. B reads Mint

- (a) Only I and II
- (b) Only III
- (c) Only II and III
- (d) Only II
- (e) All are true

Directions (152-153): Study the following information carefully and answer the below questions. In a certain code language:

- 'Judo Golf Cycling Rugby Fencing' means '23 84 69 28 59',
- 'Soccer Rugby Pool Hockey Karate' means '36 76 90 15 84',
- 'Curling Archery Soccer Fencing Golf' means '91 23 28 52 36',
- 'Fencing Pool Soccer Cricket Judo' means '59 15 36 82 23'

Q152. What is the sum of the code of "Cricket" and "Fencing" in the given code language?

- (a) 58
- (b) 76
- (c) 95
- (d) 60
- (e) 105

Q153. Which of the following is the code for "Golf cricket" in the given code language?

- (a) 67 32
- (b) 82 48
- (c) 82 28
- (d) 96 51
- (e) None of the above

Directions (154-156): In the following questions, the symbols “+, &, !, *” are used with the following meanings as illustrated below. Study the following information carefully and answer the below questions.

A+B (15m) - A is 20m north of B

A&B (13m) - A is 11m south of B

A*B (25m) - A is 22m east of B

A!B (13m) - A is 20m west of B

G+Q (19), P*G (15), T&R (13), F*L+Q, Q!T (8), F!R (2), F&M (11), P+S+E, S*M, F!E!R

Q154. What is the shortest distance between P and E?

- (a) 13m
- (b) 21m
- (c) 20m
- (d) 14m
- (e) 11m

Q155. Which of the following point is to the north of E?

- (a) Point F
- (b) Point G
- (c) Point M
- (d) Point S
- (e) Point L

Q156. In which direction is R with respect to Q?

- (a) North-west
- (b) South-east
- (c) Can't be determined
- (d) South-west
- (e) North-east

Directions (157-161): Study the following information carefully and answer the questions given below.

Twelve animals viz. Camel, Duck, Sheep, Bull, Monkey, Goat, Yak, Hen, Cow, Ox, Donkey and Buffalo were caged in two different flats viz. Flat 1 and Flat 2 of a six-storey building, but not necessarily in the same order. Flat 1 is to the west of flat 2. Flat 1 of floor 2 is immediately above flat 1 of floor 1 and immediately below flat 1 of floor 3 and so on, as well as flat 2 of floor 2 is immediately above flat 2 of floor 1 and immediately below flat 2 of floor 3 and so on.

Not more than two floors are there below Duck whereas Sheep was caged on the floor immediately above Duck but in a different flat as Duck. The number of floors above Sheep is the same as the number of floors below Ox which was not caged in flat 1 but in the same flat as Sheep. Two floors are there between Ox and Goat where both were caged in different flats. The number of floors between Goat and Duck is one less than the number of floors between Ox and Buffalo, which was not caged on the adjacent floor of Goat. The number of floors below Buffalo is one more than the number of floors above Yak. Monkey was caged in the flat immediately below Yak. Hen was caged in the flat which is three floors above Cow but in a different flat as Cow. Bull was caged in one of the odd numbered floors and flat. Camel was not caged on the same floor as Bull.

Q157. As many floors below Cow as above ____.

- (a) Sheep
- (b) Camel
- (c) Bull
- (d) Donkey
- (e) None of these

Q158. If Buffalo is related to Cow and Hen is related to Sheep in a certain way, then Ox is related to which of the following animal?

- (a) Goat
- (b) Yak
- (c) Monkey
- (d) Camel
- (e) None of these

Q159. Which of the following animal was caged on the same floor as Ox?

- (a) Yak
- (b) Sheep
- (c) Bull
- (d) Camel
- (e) None of these

Q160. Donkey was caged in which of the following floor and flat?

- (a) Flat 2 of floor 5
- (b) Flat 1 of floor 3
- (c) Flat 2 of floor 2
- (d) Flat 1 of floor 6
- (e) None of these

Q161. Four of the following five are alike in a certain way as per the given arrangement and hence form a group. Find the one that doesn't belong to that group?

- (a) Yak
- (b) Duck
- (c) Bull
- (d) Cow
- (e) Buffalo

Directions (162-166): In each of the following questions, two rows of numbers are given. The resultant number in each row is to be worked out separately based on the following rules and the question below the rows of numbers are to be answered. The operations of numbers progress from left to right.

Rules:

- (I) If an even number is followed by an odd number, then both the numbers are to be added.
- (II) If an even number is followed by another even number, then divide the first number by the second number.
- (III) If an odd number is followed by an even number, then both the numbers are multiplied.
- (IV) If an odd number is followed by another odd number (but a perfect square), then the difference between both the numbers is obtained.

Q162. What is the product of the resultant of the first row and the second row?

13 25 6

32 8 15

- (a) 32
- (b) 40
- (c) 38
- (d) 36
- (e) 28

Q163. If X is three more than the resultant of the first row, then what will be the resultant of the second row?

17 24 136

165 81 X

- (a) 9
- (b) 14
- (c) 22
- (d) 97
- (e) 210

Q164. If the resultant of the first row and the second row is added, then what is the square root of the sum (Approximately)?

13 26 21
192 24 69

- (a) 29
- (b) 22
- (c) 35
- (d) 32
- (e) 21

Q165. If the sum of the resultants of the two rows is 450. Then find the value of X?

84 11 X
34 45 9

- (a) 6
- (b) 10
- (c) 5
- (d) 2
- (e) 4

Q166. Find the division of the resultant of 1st row with the resultant of 2nd row?

5 16 4
32 8 7

- (a) 4
- (b) 5
- (c) 9
- (d) 2
- (e) 7

Directions (167-171): Study the following information carefully and answer the below questions.

Seven employees viz. P, Q, R, S, T, U and V were promoted during nine different years viz. 2004, 2001, 1998, 1996, 1993, 2012, 2018, 2009, and 2015. Only one person was promoted in each year and in any two years no persons were promoted and that two years are not adjacent to each other. Each person likes different movies viz. Pathaan, Dangal, Sanju, RRR, Krrish 3, Bharat and Kesari. All the information is not necessary in the same order.

P was promoted in 2015 but neither likes Bharat nor Dangal. Three persons were promoted between P and the one who likes Kesari. Q was promoted in a leap year but not in 1996 and three persons before the one who likes Bharat. Q likes neither Kesari nor Pathaan. One person was promoted between S and the one who likes Pathaan. The number of persons promoted between the one who likes Bharat and S is the same as the number of persons promoted before U. S was not promoted before the one who likes Pathaan. The one who likes Pathaan was promoted in an even numbered year. R likes Krrish 3 and P doesn't like Sanju. The number of persons promoted between R and the one who likes Sanju is one more than the number of persons promoted after the one who likes RRR. The one who likes Dangal was not promoted in 2012. T doesn't like Bharat.

Q167. Who among the following person likes Sanju?

- (a) S
- (b) T
- (c) Q
- (d) V
- (e) None of these

Q168. Who among the following person was promoted in 1996?

- (a) The one who likes RRR
- (b) V
- (c) The one who likes Kesari
- (d) The one who likes Krrish 3
- (e) None of these

Q169. Who among the following person likes Pathaan?

- (a) T
- (b) P
- (c) V
- (d) U
- (e) None of these

Q170. How many persons were promoted between the one who likes Kesari and T?

- (a) One
- (b) Two
- (c) Three
- (d) Four
- (e) None

Q171. Which of the following statement is true?

- (a) The one who was promoted immediately after Q likes RRR
- (b) T was promoted two persons after the one who likes Krrish 3
- (c) S likes Bharat
- (d) Three persons were promoted after the one who likes RRR
- (e) None of the above statements are true

Directions (172-174): Study the following information carefully and answer the questions given below.

There are seven members T, U, V, W, X, Y and Z in a family which consists of three generations.

P & Q means P is the son of Q.

P % Q means P is married to Q.

P \$ Q means P is the daughter of Q.

P # Q means the gender of P and Q are different from each other.

Z # W, Y \$ T, V & X, T % W, T # X. X has only two sisters. U is the nephew of the sibling of Y. T has no sibling. U has a brother. X belongs to the second generation.

Q172. Which among the following statements is/are true?

- (a) U # Y # X
- (b) V \$ Z
- (c) X & T # Y
- (d) Z & X
- (e) None of the above statement is true

Q173. How is Z related to U's aunt's mother?

- (a) Sister
- (b) Daughter
- (c) Daughter-in-law
- (d) Son
- (e) None of These

Q174. How is W related to Z's brother?

- (a) Mother
- (b) Uncle
- (c) Father
- (d) Son
- (e) None of These

Directions (175-179): Study the following information carefully and answer the questions given below.

Eight persons A, B, C, D, E, F, G and H are sitting around a square table in such a way that four of them sit at the corners and four of them sit at the middle of the sides of the table. All of them are facing the centre of the square table.

F is an immediate neighbour of C who sits at the corner of the table. B sits third to the left of A. One person sits between B and C. As many persons sit between B and F as sit between B and H. E sits second to the left of D. The number of persons sit between G and A is one less than the number of persons sit between D and A when counted from the left of both D and G.

Q175. Who among the following person sits second to the left of C?

- (a) A
- (b) E
- (c) B
- (d) None of these
- (e) G

Q176. Which among the following pair of persons are immediate neighbours of each other?

- (a) GC
- (b) EF
- (c) AG
- (d) HD
- (e) BG

Q177. If all the persons are arranged in alphabetical order from A in a clockwise direction, then how many persons are unchanged in their positions (Excluding A)?

- (a) Four
- (b) None
- (c) Three
- (d) Two
- (e) One

Q178. What is the position of C with respect to H?

- (a) Third to the right
- (b) Second to the left
- (c) Immediate left
- (d) Immediate right
- (e) Second to the right

Q179. Which of the following statement(s) is/are false with respect to the final arrangement?

- I. H and D are immediate neighbors
- II. B sits third to the right of E
- III. Only one person sits between G and F

- (a) Only II
- (b) Only II and III
- (c) Only III
- (d) All I, II, and III
- (e) None of these

Directions (180-184): Read the following alphanumeric symbol series carefully and answer the questions given below.
N ! 5 T 2 O @ Q 1 W R \$ 6 O ^ P U * J 7 S % D 8 F ? 9 A V + B > 3 Z P K

Q180. If the numbers are arranged from the right to left in the ascending order after the last element and the position of the rest of the elements remain same, then which of the following element will be placed 18th from the right end?

- (a) J
- (b) S
- (c) %
- (d) F
- (e) D

Q181. If all the symbols and the numbers are dropped from the given series, then which of the following element is fifth from the right end in the series thus formed?

- (a) F
- (b) V
- (c) S
- (d) J
- (e) D

Q182. Four of the following five are alike in a certain way as per the given arrangement and hence form a group. Find the one that doesn't belong to that group.

- (a) O\$
- (b) R^
- (c) D9
- (d) V3
- (e) N2

Q183. How many consonants are immediately followed by a number in the given series?

- (a) Four
- (b) Three
- (c) Two
- (d) Five
- (e) More than five

Q184. What is the sum of the numbers which are immediately followed by a vowel in the given series?

- (a) 18
- (b) 19
- (c) 16
- (d) 15
- (e) None of the above

Q185. If in the given number "68395722689", all the prime digits are increased by one and the remaining digits are decreased by one, then what is the sum of the all the digits which are repeated more than once in the new arrangement?

- (a) 30
- (b) 45
- (c) 23
- (d) 37
- (e) 24

Directions (186-190): A string of numbers is given as input. The further steps given are obtained by applying certain logic. Each step is a resultant of previous step only. Study the following information carefully and answer the questions given below it.

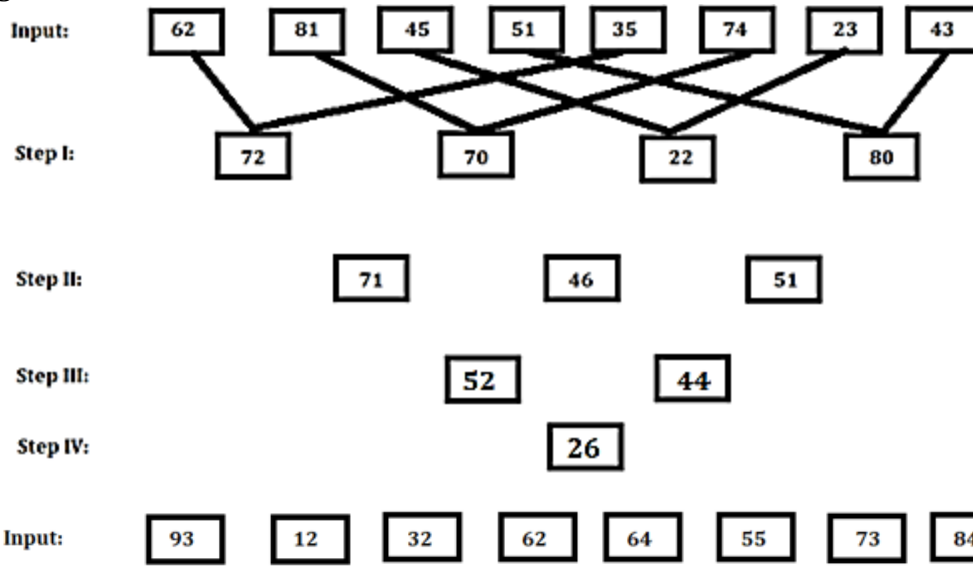

Q186. Find the final step box number of the given input from the following?

- (a) 100
- (b) 90
- (c) 120
- (d) 00
- (e) None of these

Q187. What will be the difference between the second and the last numbers from the left end in step 1 of the given input?

- (a) 12
- (b) 20
- (c) 30
- (d) 18
- (e) None of these

Q188. Which of the following is the third number from the right end in step II of the given input?

- (a) 18
- (b) 24
- (c) 63
- (d) 36
- (e) None of these

Q189. Calculate the square of the third number from the left end in step I of the given input?

- (a) 121
- (b) 81
- (c) 361
- (d) 196
- (e) None of these

Q190. Find the sum of the second number from the left end in step I and in step III of the given input?

- (a) 113
- (b) 84
- (c) 90
- (d) 70
- (e) None of these

Directions (191-193): The question given below consists of three statements numbered I, II and III given below it. You have to decide which of the statements are redundant to answer the question. Read all the statements and give answer.

Q191. There are six persons P, Q, R, S, T and U sitting in a horizontal row but not necessarily in the same order. Equal number of people are facing north and south. The persons at extreme ends face in the same direction. Not more than two persons sitting adjacent to each other face in the same direction. Who among the following sits to the immediate left of S?

Statement I: S sits second to the right of P. There is one person between Q and P. T does not face in north.

Statement II: There are two persons between T and S. Q and U face in same direction. P sits adjacent to T.

Statement III: R and S face in same direction. R sits exactly between U and T who does not sit at any end. U is not adjacent to Q.

- (a) Data in only statement II is redundant
- (b) Data in either statement I or III is redundant
- (c) Data in only statement III is redundant
- (d) Data in both statements II and III are redundant
- (e) None of These

Q192. There are six buses Q, R, S, T, U and V which are parked in the row and all are facing north direction but not necessarily in the same order. The buses are numbered from 1 to 6 from left to right. Which buses are parked immediate adjacent to the bus V?

Statement I: Bus R which is parked two places away from bus Q and parked third to the left of bus U.

Statement II: Bus U which is parked at one end of the row is adjacent to bus T.

Statement III: Bus S which is parked two places away from the bus which is parked at one end of the row.

- (a) Data given in statement I alone is redundant to answer
- (b) Data given in both statements I and II is redundant to answer
- (c) Data given in statement III alone is redundant to answer
- (d) Data given in all three statements I, II, and III is not redundant to answer
- (e) None of the These

Q193. Seven persons M, N, O, P, Q, R and S sit around the circular table facing towards the centre but not necessarily in the same order. Who sits to the immediate right of M?

Statement I: N sits third to the left of P. One person sits between P and M who is not adjacent to N. O sits to the immediate left of Q. R does not sit adjacent to P.

Statement II: O and N are adjacent to each other. M sits adjacent to S. Q sits second to the right of N.

Statement III: R sits third to the right of P who sits immediate right of Q. M sits immediate right of S who doesn't sit adjacent to R. O does not sit adjacent to R.

- (a) Data in only statement II is redundant
- (b) Data in either statement II or III is redundant
- (c) Data in only statement III is redundant
- (d) Data in both statements I and III are redundant
- (e) None of These

Directions (194-198): In each of the following questions, the relationship between different elements are given in the statement followed by two sets of conclusions. Study the following information carefully and decide which of the following conclusion logically follows.

"P @ Q" means "P is greater than Q"

"P % Q" means "P is not greater than Q"

"P # Q" means "P is less than Q"

"P & Q" means "P is not less than Q"

"P ^ Q" means "P is neither greater than nor less than Q"

Q194. Statements: R#N%G#L; M#X&Z@L

Conclusions: I. N#X II. M@L

- (a) If only conclusion I follow
- (b) If only conclusion II follows
- (c) If either conclusion I or II follows
- (d) If neither conclusion I nor II follows
- (e) If both conclusions I and II follow

Q195. Statements: M%T#S^Z#A; M&X&Y^C

Conclusions: I. C%T II. A@Y

- (a) If only conclusion I follow
- (b) If only conclusion II follows
- (c) If either conclusion I or II follows
- (d) If neither conclusion I nor II follows
- (e) If both conclusions I and II follow

Q196. Statements: N#M&P^W@V; S%J#Q@W

Conclusions: I. M@J II. N#S

- (a) If only conclusion I follow
- (b) If only conclusion II follows
- (c) If either conclusion I or II follows
- (d) If neither conclusion I nor II follows
- (e) If both conclusions I and II follow

Q197. Statements: L@Q&M^P; R%N^G%P

Conclusions: I. Q@R II. R^Q

- (a) If only conclusion I follow.
- (b) If only conclusion II follows.
- (c) If either conclusion I or II follows.
- (d) If neither conclusion I nor II follows.
- (e) If both conclusions I and II follow

Q198. Statements: S@N&Q^R; L^J%R; L#T@M

Conclusions: I. T@Q II. N&L

- (a) If only conclusion I follow
- (b) If only conclusion II follows
- (c) If either conclusion I or II follows
- (d) If neither conclusion I nor II follows
- (e) If both conclusions I and II follow

Directions (199-200): The question given below consists of three statements numbered I, II, and III below them. You have to decide whether the data provided in the statements are sufficient to answer the question. Read all the statements and give answer.

Q199. In a certain language, 'take clean water for good health' is coded as `ptc, Inc, ckc, roc, tec, vgc'. What is the code for 'water'?

Statement I: 'take milk everyday' is coded as `rcc, snc, ptc' and 'health is very good' is coded as sbd, vgc, tec, lkc'.

Statement II: 'water is very clean' is coded as `bdc, ckc, Inc, lkc' and 'you clean everyday' is coded as 'xtc, snc, Inc'

Statement III: 'liquid for take' is coded as 'ptc, kz, roc' and 'take pure water' is coded as 'ckc, ptc, okc'.

- (a) Data given in either statement I or II alone is sufficient to answer
- (b) Data given in either statement II or III alone is sufficient to answer
- (c) Data given in both statements II and III are together not sufficient to answer
- (d) Data given in both statements I and III are together not sufficient to answer
- (e) Data given in any of the statements I, II and III are together not sufficient to answer

Q200. Six boxes A, B, C, D, E and F are kept one above another such that bottommost box is numbered as 1 while the topmost box is numbered as 6 but not necessarily in the same order. Which box is the topmost box?

Statement I: Box B is two boxes above box A but not the topmost box. Box E is 2nd box.

Statement II: Box C is two boxes above box E which is an even numbered box. Box F is just above box B.

Statement III: Box E is not the topmost box. Box C is just above box A.

- (a) Data given in both statements I and II together or statement III alone is sufficient to answer.
- (b) Data given in both statements II and III are together sufficient to answer.
- (c) Data given in both statements I and II are together sufficient to answer.
- (d) Data given in both statements I and III are together sufficient to answer.
- (e) Data given in all three statements I, II and III are together not sufficient to answer.



Solutions

S1. Ans.(d)

Sol. About National Means cum Merit Scholarship Scheme (NMMSS)

1. The National Means cum Merit Scholarship Scheme (NMMSS) is integrated into the National Scholarship Portal (NSP), serving as a comprehensive platform for various student scholarship programs.
2. Scholarships under NMMSS are transferred directly to the selected students' bank accounts via electronic transfer through the Public Financial Management System (PFMS), adhering to the Direct Benefit Transfer (DBT) method.
3. NMMSS is classified as a Central Sector Scheme.
4. Eligibility for the scholarship requires a parental income of **no more than Rs. 3,50,000/-** per annum from all sources.
5. To qualify for the selection test, students must achieve at least 55% marks or an equivalent grade in their Class VII examination, with a 5% relaxation for SC/ST students.
6. The scheme includes two levels of verification: L1 (Institute Nodal Officer Level) and L2 (District Nodal Officer Level).
7. The deadline for L1 verification is set for 15th January 2024, and for L2 verification, it is 30th January 2024.

S2. Ans.(c)

Sol. The Reserve Bank of India has exempted the requirement for an Additional Factor of Authentication (AFA) for certain payment categories, for transactions up to **₹1,00,000**. This move simplifies the process and encourages more digital transactions in specific sectors.

S3. Ans.(e)

Sol. All of the above

Overview of Minority Community Development Schemes:

1. **Naya Savera - Free Coaching and Allied Scheme:**
 - This scheme is dedicated to providing free coaching to students from minority communities who are economically weaker. It focuses on preparing them for entrance exams of technical/professional courses and various competitive examinations.
2. **Padho Pardesh:**
 - A scheme offering interest subsidy on educational loans for overseas higher studies to students from economically weaker sections of minority communities.
3. **Nai Roshni:**
 - Aimed at leadership development, this program focuses on women belonging to minority communities, enhancing their leadership skills and capabilities.
4. **Seekho Aur Kamao:**
 - A skill development initiative targeting youth aged 14 - 35 years from minority communities. The scheme aims to improve the employability of existing workers and school dropouts.
5. **Pradhan Mantri Jan Vikas Karyakram (PMJVK):**
 - Designed to address developmental deficits in Minority Concentration Areas, this program identifies areas based on minority population and socio-economic data from Census 2011 for targeted development.
6. **USTTAD (Upgrading the Skills and Training in Traditional Arts/Crafts for Development):**
 - Launched in May 2015, USTTAD aims to preserve the rich heritage of traditional arts and crafts of indigenous artisans. The scheme includes organizing HunnarHaats across the country to provide a national marketing platform for Minority artisans and entrepreneurs, also creating employment opportunities.
7. **Prime Minister-Virasat Ka Samvardhan (PM Vikaas):**
 - A new addition in 2023 to the Ministry of Minority Affairs' budget, PM Vikaas is a skilling initiative focusing on the skilling, entrepreneurship, and leadership training of minority and artisan communities. This scheme aligns with the 'Skill India Mission' of the Ministry of Skill Development & Entrepreneurship and integrates with the Skill India Portal (SIP).

S4. Ans.(b)

Sol. Recently, the Union Cabinet has given the green light to the terms of reference (ToR) for the Sixteenth Finance Commission. This commission holds the critical responsibility of recommending the formula for revenue distribution between the Centre and the States for the upcoming five-year period starting from **April 1, 2026**.

S5. Ans.(b)

Sol. The theme for World AIDS Day 2023 is 'Let communities lead.'

Every year on 1st December, World AIDS Day is commemorated globally to raise awareness about Human Immunodeficiency Virus (HIV)/Acquired Immuno Deficiency Syndrome (AIDS) and honor those who have succumbed to it.

World Aids Day was first observed in 1988 when the World Health Organisation (WHO) recognized the day.

S6. Ans.(c)

Sol. The name 'Michaung' for the tropical cyclone in the Bay of Bengal was suggested by **Myanmar**.

The National Crisis Management Committee (NCCM) recently convened to assess the readiness of State governments and Central Ministries for the approaching cyclone 'Michaung' in the Bay of Bengal.

The India Meteorological Department (IMD) reported the storm's current location and projected path, indicating potential landfall in coastal Andhra Pradesh.

The NCCM is a committee set up to coordinate and implement relief measures and operations in the wake of a natural calamity.

S7. Ans.(a)

Sol. Jan Shikshan Sansthan (JSS) Scheme: The main target of the JSS is to impart vocational skills to the non-literates, neo-literates, and persons having a rudimentary level of education and school dropouts up to 12th standard in the age group of **15-45 years**, with due age relaxation in case of "Divyangjan" and other deserving cases. Priority is given to Women, SC, ST, OBC, and Minorities in the rural areas and urban low-income areas.

S8. Ans.(c)

Sol. The **Employees' State Insurance Corporation (ESIC)** bagged the "ISSA Vision Zero 2023" Award in the recently held 23rd World Congress on Safety and Health at Work in Sydney, Australia. "Vision Zero" is a transformational approach to the prevention of accidents at workplaces integrating the three dimensions of safety, health, and well-being at all levels of work.

S9. Ans.(b)

Sol. Within the Pradhan Mantri Krishi Sinchayee Yojana (PMKSY), the Watershed Development (WD) component is implemented by the **Department of Land Resources**. This component plays a crucial role in managing and developing watersheds, contributing to the overall objective of efficient water management in agriculture, thereby complementing the scheme's broader goals of enhancing irrigation and water conservation in farming.

About Pradhan Mantri Krishi Sinchayee Yojana (PMKSY)

1. Launch and Objectives:

- The Pradhan Mantri Krishi Sinchayee Yojana (PMKSY) was initiated in 2015-16, aiming to enhance water accessibility on farms, expand areas under assured irrigation, and improve on-farm water use efficiency. It also focuses on introducing sustainable water conservation practices.

2. Umbrella Scheme Structure:

- PMKSY is an umbrella scheme with two major components executed by the Ministry of Jal Shakti: **Accelerated Irrigation Benefit Programme (AIBP) and Har Khet Ko Pani (HKKP)**.

3. HKKP Sub-components:

HKKP includes four sub-components:

- (i) Command Area Development & Water Management (CAD&WM),
- (ii) Surface Minor Irrigation (SMI)
- (iii) Repair, Renovation, and Restoration (RRR) of Water Bodies
- (iv) Ground Water (GW) Development.

4. Watershed Development Component:

- The Watershed Development (WD) aspect of PMKSY is managed by the Department of Land Resources, focusing on watershed management and development.

5. Per Drop More Crop (PDMC) Component (2015-22):

- During 2015-22, the Per Drop More Crop (PDMC) component, aimed at enhancing water use efficiency, was implemented by the Department of Agriculture and Farmers Welfare (DoA&FW) as part of PMKSY.

S10. Ans.(b)

Sol. **HDFC Bank**, in collaboration with Crunchfish AB, developed the 'Offline Retail Payments' product, which has been approved by the Reserve Bank of India (RBI). This innovative product allows transactions in offline mode, enhancing the convenience and accessibility of digital payments.

S11. Ans.(e)

Sol. Provision of Vulnerability Reduction Fund (VRF) up to **Rs. 1,50,000** per Village Organization (VO). This is a corpus fund given to the VO/Primary Level Federation at the Village level to address vulnerabilities faced by the individuals or household(s) or communities.

S12. Ans.(c)

Sol. The Ministry of Culture administers a Scheme by the name of "Scheme for Financial Assistance for Veteran Artists" for senior artists aged 60 years and above who have contributed significantly in their specialized fields of performing arts and culture but are facing financial difficulties due to old age.

As per the extant Scheme guidelines financial assistance up to **Rs. 6000/-** per month is being provided to the selected artists irrespective of the States/UTs to which the concerned beneficiary belongs.

S13. Ans.(c)

Sol. The SEBI board's amendments to the Real Estate Investment Trusts (REITs) Regulations have established that Small and medium REITs (SM REITs) must have a minimum asset value of at least **₹50 crore**. This amendment is aimed at creating a more inclusive and diverse regulatory framework for REITs.

S14. Ans.(c)

Sol. As per the operational guidelines of the Pradhan Mantri Fasal Bima Yojana, designated block/district-level grievance redressal officers are required to respond to grievances **within 7 days of receipt**. This prompt response time ensures that the grievances of Farmers, Banks, Insurance Companies, and other stakeholders are addressed promptly and effectively.

S15. Ans.(d)

Sol. Exclusion Categories

The following categories of beneficiaries of higher economic status shall not be eligible for benefit under the scheme:

- All Institutional Landholders.
- Farmer families in which one or more of its members belong to the following categories
- Former and present holders of constitutional posts
- Former and present Ministers/ State Ministers and former/present Members of Lok Sabha/ Rajya Sabha/ State Legislative Assemblies/ State Legislative Councils, former and present Mayors of Municipal Corporations, former and present Chairpersons of District Panchayats.
- All serving or retired officers and employees of Central/ State Government Ministries /Offices/Departments and its field units Central or State PSEs and Attached offices /Autonomous Institutions under Government as well as regular employees of the Local Bodies (Excluding Multi-Tasking Staff /Class IV/Group D employees)
- All superannuated/retired pensioners whose **monthly pension is Rs.10,000/-or** more (Excluding Multi-Tasking Staff / Class IV/Group D employees) of the above category
- All Persons who paid Income Tax in the last assessment year
- Professionals like Doctors, Engineers, Lawyers, Chartered Accountants, and Architects registered with Professional bodies and carrying out their profession by undertaking practices.

S16. Ans.(c)

Sol. The '**Garba of Gujarat**' was inscribed in the Representative List of Intangible Cultural Heritage (ICH) of Humanity by UNESCO during the 18th meeting of the Intergovernmental Committee for the Safeguarding of the Intangible Cultural Heritage. This meeting occurred from 5th to 9th December 2023 in Kasane, Botswana. Garba, a traditional dance form from Gujarat, is recognized for its cultural significance and contribution to the intangible cultural heritage.

S17. Ans.(c)

Sol. According to the "Crime in India 2022" report by the NCRB, **Kolkata emerged as the safest city** in India for the third consecutive year. The city recorded the least number of cognizable offenses per lakh population among the metropolitan cities. This ranking is significant in understanding the safety and crime dynamics in Indian cities. **Pune (Maharashtra) and Hyderabad (Telangana) were ranked second and third, respectively.**

Key Points on Suicides and Causes in India in 2022:

1. Increase in Suicide Cases:

☑ India recorded over 1.7 Lakh suicide cases in 2022, marking a rise of 4.2% compared to 2021.

2. Suicide Rate Growth:

☑ There was a 3.3% increase in the suicide rate, calculated per lakh of the population.

3. Primary Causes of Suicides:

☑ Major causes leading to suicides were family problems, marriage-related issues, bankruptcy and indebtedness, unemployment and professional challenges, and illnesses.

4. State-wise Distribution:

☑ Maharashtra reported the highest number of suicides, followed by Tamil Nadu, Madhya Pradesh, Karnataka, Kerala, and Telangana.

5. Daily Wage Earners:

☑ Daily wage earners formed 26.4% of the total suicide cases, highlighting their vulnerability.

6. Impact on Agricultural Sector:

☑ A significant portion of suicides involved agricultural workers and farmers, indicating distress in the agricultural sector.

7. Unemployment and Students:

☑ Unemployed individuals comprised 9.2% of the total suicides, with over 12,000 students also committing suicide.

Crimes Against SCs and STs:

1. Overall Increase in Crimes:

☑ There was a notable rise in crimes against Scheduled Castes (SC) and Scheduled Tribes (ST).

2. State-wise Surge:

☑ States like Rajasthan, Madhya Pradesh, Chhattisgarh, and Telangana saw increased cases.

3. Consistent Contributors:

☑ Madhya Pradesh and Rajasthan remained among the top states for the highest occurrences of crimes against SC and ST communities.

4. Other Affected States:

☑ Elevated offenses against SCs and STs were also noted in Bihar, Uttar Pradesh, Odisha, and Punjab.

S18. Ans.(c)

Sol. AIF envisages the creation of post-harvest management infrastructure and community farming assets through incentives and financial support. It includes interest subvention of 3% for a loan up to Rs. 2 Crore per project **location for 7 years** and reimbursement of credit guarantee fee if the project has credit guarantee cover under the Credit Guarantee Fund Trust for Micro and Small Enterprises (CGTMSE) Scheme.

S19. Ans.(c)

Sol. The primary aim of the Pradhan Mantri Annadata Aay SanraksHan Abhiyan (PM-AASHA) is **to ensure that farmers receive the Minimum Support Price (MSP) for their produce of notified oilseeds, pulses, and copra.** This scheme comprises the Price Support Scheme (PSS), Price Deficiency Payment Scheme (PDPS), and Private Procurement and Stockist Scheme (PPSS), all of which are geared towards supporting farmers financially and stabilizing agricultural income.

S20. Ans.(e)

Sol. Recently (December 2023), the India Infrastructure Report (IIR) 2023 on Urban Planning and Development was released, it is a comprehensive document that covers various aspects of infrastructure planning, finance, and governance in the country. The IIR 2023 has been a collaborative effort of the **IDFC Foundation, Infrastructure Development Corporation (Karnataka) Ltd. (iDeCK), and the National Institute of Urban Affairs (NIUA).**

S21. Ans.(e)

Sol. The Ayushman Bharat Pradhan Mantri - Jan Arogya Yojana (AB PM-JAY) offers health coverage of ₹5 lakhs per family per year through Ayushman cards. This coverage is specifically for secondary and tertiary care hospitalization, aiming to provide substantial healthcare support to families, particularly those from economically weaker sections.

S22. Ans.(b)

Sol. Jacques Delors, the former European Commission chief, was a key figure in the formation of the **European Union (EU)**. He played a crucial role in shaping the EU during his presidency, from January 1985 to the end of 1994. His contributions were instrumental in the development and strengthening of the EU.

S23. Ans.(d)

Sol. The Reserve Bank of India (RBI) has classified the **State Bank of India (SBI)** in Bucket 4 as a Domestic Systemically Important Bank (D-SIB), necessitating an additional Common Equity Tier 1 (CET1) requirement of 0.80%. This classification underlines the significance of SBI in the stability of India's financial system.

S24. Ans.(d)

Sol. Apart from India, the top five remittance recipient countries include **Mexico (USD 67 billion), China (USD 50 billion), the Philippines (USD 40 billion), and Egypt (USD 24 billion).**

Additional Info

1. India's Dominant Position:

☑ India has emerged as the top recipient in global remittances, with a total of \$125 billion in 2023.

2. Growth in Remittances:

☑ Remittances to low- and middle-income countries saw an overall growth of 3.8%.

3. Regional Challenges:

☑ There were notable declines in remittances from regions such as the Middle East and North Africa.

4. Importance of Inclusive Policies:

☑ The report highlights the importance of having inclusive labor markets and robust social protection policies to sustain and grow remittance flows.

S25. Ans.(c)

Sol. **Aster Medcity, located in Kochi, Kerala, and a unit of Aster DM Healthcare**, has been ranked No.1 in the 'Best Multi-specialty Hospital Emerging' category by The Week-Hansa Research 2023. This achievement highlights the hospital's excellence in healthcare delivery and its emerging prominence in the healthcare industry.

S26. Ans.(d)

Sol. The RBI mandates that Regulated Entities (REs) and their Internal Ombudsmen (IOs) must communicate a final decision on customer complaints **within 30 days** of receiving them. This timeframe is crucial for ensuring the timely resolution of consumer grievances and improving customer service standards.

S27. Ans.(b)

Sol. If the PMI of the current month is lower than the PMI of the previous month, it indicates that the **economy is contracting**. This trend suggests a slowdown in manufacturing and service sector activities compared to the previous month.

S28. Ans.(b)

Sol. **Himachal Pradesh** recorded the highest overall unemployment rate at 33.9% among the age group of 15 to 29 years in urban areas during the July-September quarter of 2023, as per the Periodic Labour Force Survey (PLFS) conducted by the National Sample Survey Office (NSSO). This rate makes it the state with the most significant joblessness challenge in this demographic for the specified quarter.

S29. Ans.(a)

Sol. The Yogi Adityanath government is reportedly considering renaming Ayodhya's international airport to "**Maharishi Valmiki Airport.**" Maharishi Valmiki is revered for authoring the epic Ramayana, and the proposed name change aims to honor his contribution to Indian literature and culture.

S30. Ans.(b)

Sol. The RBI's master direction on the Internal Ombudsman for lenders introduced the new role of **Deputy Internal Ombudsman**. This role aims to strengthen the IO mechanism and enhance the efficiency of the internal grievance redress system in regulated entities.

S31. Ans.(c)

Sol. The new grievance redressal process outlined by SEBI is aimed at resolving complaints within a **maximum of 60 days**, ensuring a timely response to investor grievances.

S32. Ans.(d)

Sol. It was launched by the Ministry of Labour and Employment on 26th August 2021 for the creation of the **National Database of Unorganized Workers**.

Accordingly, the Ministry of Labour & Employment has developed an ashram portal for creating a National Database of Unorganized Workers (NDUW), which will be seeded with Aadhaar. It will have details of name, occupation, address, occupation type, educational qualification, skill types, etc. for optimum realization of their employability and extend the benefits of the social security schemes to them. It is the first-ever national database of unorganized workers including migrant workers, construction workers, gig and platform workers, etc.

S33. Ans.(b)

Sol. PM-PRANAM stands for **PM Programme for Restoration, Awareness, Nourishment, and Amelioration of Mother Earth**.

About:

☑ PM-PRANAM was first announced in the **2023-24 Budget by the Union government**.

☑ The scheme aims to **reduce the use of chemical fertilizers** by incentivizing states to adopt alternative fertilizers.

Objective:

☑ Encourage the balanced use of fertilizers in **conjunction with biofertilizers and organic fertilizers**.

☑ Reduce the **subsidy burden on chemical fertilizers**, which was around Rs 2.25 lakh crores in 2022-2023.

Key Features of the Scheme:

Financing:

☑ The scheme will be financed by the **savings of existing fertilizer subsidies** under schemes run by the Department of Fertilizers, Ministry of Chemicals & Fertilizers.

☑ There will be **no separate budget for the PM-PRANAM scheme**.

Subsidy Savings and Grants:

☑ The Centre will provide **50% of the subsidy savings** to the states as a grant.

☑ Out of the grant, **70% can be used to create assets** related to the **technological adoption of alternative fertilizers** and production units at various levels.

☑ The remaining **30% can be used to reward** and encourage farmers, panchayats, and other stakeholders involved in fertilizer reduction and awareness generation.

Calculation of Fertilizer Reduction:

The reduction in urea consumption by a state will be compared to its **average consumption of urea over the previous three years**.

This calculation will determine the eligibility for subsidy savings and grants.

Promotion of Sustainable Agriculture:

Encouraging the use of biofertilizers and organic fertilizers will promote sustainable agricultural practices.

This will enhance **soil fertility**, reduce environmental pollution, and support long-term agricultural productivity.

S34. Ans.(c)

Sol. The Ministry of Rural Development is implementing the Indira Gandhi National Old Age Pension Scheme (IGNOAPS) under which old age persons of 60 to 79 years belonging to BPL families are provided a pension of **₹ 200** per month. The pension amount is increased to **₹ 500** per month on attaining the age of 80 years.

S35. Ans.(a)**Sol. Jan Dhan Darshak App (JDD App)**

JDD App is a mobile application that provides a citizen-centric platform for locating banking touch points such as bank branches, ATMs, Banking Correspondents (BCs), Indian Post Payment Banks, etc. in the country. The facilities under the Jan Dhan Darshak App could be availed as per the needs and convenience of common people.

This app is also being used for the identification of villages that are yet to be covered by banking outlets within a 5 km radius. These identified villages are allocated to various banks by concerned SLBCs for the opening of banking outlets. The efforts have resulted in a significant decrease in several uncovered villages.

S36. Ans.(e)

Sol. The **Reserve Bank of India (RBI)**, led by Governor Shaktikanta Das, was recently honored with the 'Changemaker of the Year' award at the fifth edition of the prestigious business line Changemaker Awards.

• These awards, which recognize visionaries and achievers making a positive impact on society, the economy, and the planet, spanned six categories: Changemaker of the Year, Iconic Changemaker of the Year, Changemaker - Social Transformation, Changemaker - Digital Transformation, Changemaker - Financial Transformation, and Young Changemakers.

Categories	Awards
• 'Iconic Changemaker of the Year'	• AMUL (Anand Milk Union Limited)
• 'Changemaker - Social Transformation'	• Neha Bagaria, Founder and CEO of HerKey, and Safeena Hussain, Founder of Educate Girls
• 'Changemaker - Digital Transformation'	• Stellapps Technologies Private Limited
• 'Changemaker - Financial Transformation'	• Pradhan Mantri Jan Dhan Yojana (PMJDY)
• 'Young Changemaker'	• Shrinidhi RS

S37. Ans.(c)

Sol. State Bank of India (SBI) issues the bonds in denominations of **Rs 1,000, Rs 10,000, Rs 1 lakh, Rs 10 lakh, and Rs 1 crore.**

What are Electoral Bonds?

- The electoral bonds system was introduced in 2017 through a Finance bill and was implemented in 2018.
- They serve as a means for individuals and entities to make donations to registered political parties while maintaining donor anonymity.

Features:

- Payable to the bearer on demand and interest-free.
- Purchased by Indian citizens or entities established in India.
- Can be bought individually or jointly with other individuals.
- Valid for 15 calendar days from the date of issue.
- The State Bank of India (SBI) is the authorized issuer.
- Electoral Bonds are issued through designated SBI branches.

S38. Ans.(e)

Sol. All of the above

S39. Ans.(b)

Sol. Credit Institutions and Credit Information Companies have been granted **six months** to establish the necessary systems and processes for the implementation of the framework that compensates customers for delayed updates or rectifications in credit information.

S40. Ans.(d)

Sol. Project Size: Projects supported by UIDF must meet specific criteria, with a minimum project size of Rs. 5 crores (Rs. 1 crore for North-Eastern and Hilly States) and a **maximum size of Rs. 100 crores.**

S41. Ans.(a)

Sol. Beneficiary Groups:

- **Economically Weaker Section (EWS):** Families with an annual income up to Rs. 3,00,000.
- **Low-Income Group (LIG):** Families with an annual income up to Rs. 6,00,000.
- **Middle-Income Groups (MIG I & II):** Families with an annual income of up to Rs. 18,00,000.
- A beneficiary family includes a husband, wife, and unmarried sons and/or daughters.

S42. Ans.(b)

Sol. The Union Cabinet, led by Prime Minister Narendra Modi, has sanctioned an additional **Rs 2,500 crore** for the Interest Equalisation Scheme, extended until **June 30, 2024**, to support exporters and MSME manufacturer exporters.

S43. Ans.(e)

Sol. Statement B is correct while **Statements A & C are incorrect** as

- GOBARDhan supports the villages in safely managing their cattle waste, agriculture waste, and organic waste in **Rural areas**.
- It was launched in **2018** from Karnal, Haryana

Details:

- GOBARDHAN was launched **to ensure cleanliness in villages** by converting bio-waste including cattle waste, kitchen leftovers, crop residue, and market waste to improve the lives of villagers.
- This will provide **economic and resource benefits to farmers and households**.
- GOBARDhan supports the villages in **safely managing their cattle waste, agriculture waste, and organic waste** in Rural areas.
- It also helps villages convert their waste to wealth, improve environmental sanitation, and curb vector-borne diseases.
- The government of India provides Technical Assistance to every District and financial support of **up to ₹50 lakhs per district** to achieve safe disposal of cattle and organic waste.

S44. Ans.(c)

Sol. About the 'Har Ghar Jal' program:

The Har Ghar Jal Programme, implemented by the Jal Jeevan Mission under the Ministry of Jal Shakti, was announced by Prime Minister Shri Narendra Modi on August 15, 2019. The program aims to provide every rural household with affordable and regular access to an adequate supply of safe drinking water through taps. The program's components align with the WHO/UNICEF Joint Monitoring Programme for Water Supply, Sanitation, and Hygiene (JMP) to monitor progress on **SDG 6.1** for safely managed drinking water services.

S45. Ans.(b)

Sol. VAIBHAV fellows will receive a monthly fellowship grant of **INR 4,00,000**, which will support their research activities during the collaboration period.

Travel, Accommodation, and Contingencies: The fellowship will cover international and domestic travel expenses, accommodation, and contingencies, ensuring a conducive research environment for the fellows.

About Vaishvik Bhartiya Vaigyanik (VAIBHAV) fellowships program

The program will focus on **18 identified knowledge verticals**, including quantum technology, health, pharmaceuticals, electronics, agriculture, energy, computer sciences, and material sciences, among others.

Additional Info-

Eligibility: The applicant should be a Non-Resident Indian (NRI), a Person of Indian Origin (PIO), and an Overseas Citizen of India (OCI), currently living abroad.

– The applicant must have obtained a Ph.D/M.D/M.S degree from a recognized University.

– Applicant must be a researcher engaged in an overseas academic / research / industrial organization with a proven track record of research & development working in the top QS World University Ranking.

Eligibility: (for Institutions): Higher Educational Institutions / Universities ranked in the top 200 in NIRF overall rankings and have NAAC 'A' grades (3.0 and above) and scientific institutes.

S46. Ans.(c)

Sol. (a) It measures the changes in prices for all the goods and services produced in an economy.

(b) It helps economists compare the levels of real economic activity from one year to another.

(c) GDP Price Deflator = $(\text{Nominal GDP} \div \text{Real GDP}) \times 100$

(d) It is a more comprehensive inflation measure than the Consumer Price Index (CPI).

(e) Changes in consumption patterns or the introduction of new goods and services are automatically reflected in the deflator, but not in the CPI.

S47. Ans.(c)

Sol. LEADS 2023 Report: The Commerce and Industry Ministry's LEADS 2023 report identified **Andhra Pradesh, Karnataka, Tamil Nadu, Chandigarh, and Gujarat** as "achievers" in the logistics index chart for 2023.

Performance Highlights from LEADS 2023:

Categories	Achievers	Fast Movers	Aspirers
Coastal Group	Andhra Pradesh, Gujarat, Karnataka, Tamil Nadu	Kerala, Maharashtra	Goa, Odisha, West Bengal
Landlocked Group	Haryana, Punjab, Telangana, Uttar Pradesh	Madhya Pradesh, Rajasthan, Uttarakhand	Bihar, Chhattisgarh, Himachal Pradesh, Jharkhand
North-East Group	Assam, Sikkim, Tripura	Arunachal Pradesh, Nagaland	Manipur, Meghalaya, Mizoram
Union Territories	Chandigarh, Delhi	Andaman & Nicobar, Lakshadweep, Puducherry	Daman & Diu/ Dadra & Nagar Haveli, Jammu & Kashmir, Ladakh

S48. Ans.(d)

Sol. 4E Wave Portal: A dedicated online platform has been introduced to facilitate interaction among citizens across the nation, enabling information sharing and resources related to energy conservation. It encompasses four core elements:

- **Eco-friendliness:** Advocating energy-saving practices that are environmentally responsible.
- **Economy:** Promoting energy-saving solutions that yield economic benefits for both individuals and communities.
- **Education:** Focusing on educating the public about energy-saving methods and their significance.
- **Empowerment:** Empowering individuals and communities to actively engage in energy conservation efforts.

S49. Ans.(d)

Sol. The Ministry of Health and Family Welfare has launched 'MedTech Mitra': A Strategic Initiative to Empower MedTech Innovators and Advance Healthcare solutions.

About MedTech Mitra:

- **Goal:** To promote the creation of cost-effective and easily accessible domestic medical devices by offering essential support to MedTech innovators in areas such as clinical evaluation, regulatory facilitation, and the adoption of new products.
- **Launched by:** NITI Aayog, the Indian Council of Medical Research, and the Central Drugs Standard Control Organisation jointly initiated this effort.
- it aims to contribute to a decrease in import reliance, which currently stands at approximately 80% in the MedTech sector.

S50. Ans.(e)

Sol. In a significant move to ensure fair and affordable access to Aadhar Services, the Unique Identification Authority of India (UIDAI) has implemented strict measures against operators found guilty of overcharging and also **imposed a penalty of Rs.50,000 against them.** The move aims to ensure fair and accessible services for all citizens, Minister of State for Electronics and IT, Rajeev Chandrasekhar, revealed the details of these measures in a written reply to the Lok Sabha.

S51. Ans.(c)

Sol. Meghalaya's **Lakadong turmeric**, known for its high quality, has been granted the Geographical Indication (GI) tag. This distinction was announced by Agriculture Minister Ampareen Lyngdoh, who also mentioned the GI recognition of three other local products. The GI tag is a significant mark of authenticity and indicates that a product possesses certain qualities or enjoys a reputation due to its geographical origin. In this case, Lakadong Turmeric's high quality is the defining characteristic that led to its GI tag recognition, distinguishing it among other turmeric varieties and making it a noteworthy product from Meghalaya.

S52. Ans.(c)

Sol. Ministry of Environment, Forest and Climate Change has launched the **National Transit Pass System (NTPS)** - 'One Nation-One Pass' to facilitate the seamless transit of timber, bamboo, and other forest produce across the country.

Regarding the National Transit Pass System

- This system is conceptualized under the "One Nation-One Pass" framework, aiming to facilitate uninterrupted nationwide transit.
- Designed to simplify the process of obtaining timber transit permits, it offers a centralized, online platform for tree growers and farmers engaged in agroforestry throughout India, thereby enhancing the ease of conducting business.

Characteristics:

- The system provides QR-coded transit permits for hassle-free tracking and record-keeping of both inter-state and intra-state movement of timber, bamboo, and various forest products.
- Transit permits will be available for regulated tree species.
- Users can self-issue No Objection Certificates for species that are not regulated.
- Currently, 25 States and Union Territories have adopted this integrated permit system.

S53. Ans.(b)

Sol.

- The Fund of Funds for Startups Scheme, established in June 2016 with a corpus of **Rs 10,000 crore**, spreads its contribution over the 14th and 15th Finance Commission cycle based on implementation progress.
- Its primary objective is to boost the Indian startup ecosystem and facilitate access to domestic capital. **Small Industries Development Bank of India (SIDBI) operationalizes this scheme.**
- Under the FFS, it doesn't directly invest in startups. Instead, it provides capital to SEBI-registered Alternative Investment Funds (AIFs) known as daughter funds. These daughter funds then invest in growing Indian startups through equity and equity-linked instruments.
- SIDBI is responsible for selecting suitable daughter funds and overseeing the disbursement of committed capital.
- AIFs supported under FFS are required to invest at least twice the amount committed under FFS in startups.

S54. Ans.(e)

Sol. To establish Gujarat International Finance Tec-City (GIFT City), India's inaugural International Financial Services Centre (IFSC), as a worldwide center for sustainable finance, the **International Financial Services Centre Authority (IFSCA)** has established an expert committee on Transition Finance. This committee's purpose is to develop a regulatory framework that encourages the issuance of green and sustainable labeled debt securities.

S55. Ans.(b)

Sol. Statement **A** is correct while **Statements B & C** are incorrect.

- The **Juvenile Justice (Care and Protection of Children) Act, 2015** provisions and the Protection of Children from Sexual Offences Act, 2012 form the basic framework for the implementation of the Mission.
- The fund-sharing pattern is in the ratio of **60:40** between Centre and State & Union Territories with Legislature respectively.

Mission Vatsalya Scheme:

- Mission Vatsalya Scheme is a **roadmap to achieve development and child protection priorities** aligned with the **Sustainable Development Goals (SDGs)**.
- The **Juvenile Justice (Care and Protection of Children) Act, 2015** provisions and the **Protection of Children from Sexual Offences Act, 2012** form the basic framework for the implementation of the Mission.
- Funds under the Mission Vatsalya Scheme are released according to the requirements and demands made by the States/UTs.
- The Scheme is implemented as a **Centrally Sponsored Scheme in partnership with State Governments and UT Administrations** to support the States and UTs in universalizing access and improving the quality of services across the country.

The **fund-sharing pattern** is in the ratio of **60:40** between Centre and State & Union Territories with Legislature respectively.

S56. Ans.(c)

Sol. The Reserve Bank of India unveiled the eighth edition of its statistical publication, "Handbook of Statistics on Indian States, 2022-23." This publication serves as a comprehensive source for disseminating extensive data on the regional economies within India.

Report Coverage: This handbook encompasses sub-national statistics spanning socio-demographics, health, state domestic product, agriculture, environment, price and wages, industry, infrastructure, banking, and fiscal indicators across Indian states. The data spans various periods, ranging from 1951 to 2022-23.

S57. Ans.(c)

Sol.

- The Securities and Exchange Board of India (SEBI) **has approved Not-for-Profit Organisations (NPOs) to enhance their fundraising capabilities through the social stock exchange.** In a significant move, the regulator is introducing flexibility measures to facilitate this process.
- To support NPOs on the social stock exchange, SEBI has decided to decrease the minimum issue size for public issuance of Zero Coupon Zero Principal Instruments (ZCZP) from **Rs 1 crore to Rs 50 lakh.** This reduction aims to make fundraising more accessible for NPOs, fostering a conducive environment for social impact initiatives.

S58. Ans.(e)

Sol. All of the above

PM Gati Shakti is based on six pillars:

- **Comprehensiveness:** It will include all the existing and planned initiatives of various Ministries and Departments with one centralized portal. Every Department will now have visibility of each other's activities providing critical data while planning & executing projects comprehensively.
- **Prioritization:** Through this, different Departments will be able to prioritize their projects through cross-sectoral interactions.
- **Optimization:** The National Master Plan will assist different ministries in planning for projects after the identification of critical gaps. For the transportation of goods from one place to another, the plan will help in selecting the most optimum route in terms of time and cost.
- **Synchronization:** Individual Ministries and Departments often work in silos. There is a lack of coordination in the planning and implementation of the project resulting in delays. PM Gati Shakti will help in synchronizing the activities of each department, as well as of different layers of governance, holistically by ensuring coordination of work between them.
- **Analytical:** The plan will provide the entire data in one place with GIS-based spatial planning and analytical tools having 200+ layers, enabling better visibility to the executing agency.
- **Dynamic:** All Ministries and Departments will now be able to visualize, review, and monitor the progress of cross-sectoral projects, through the GIS platform, as the satellite imagery will give on-ground progress periodically and the progress of the projects will be updated regularly on the portal. It will help in identifying the vital interventions for enhancing and updating the master plan.

S59. Ans.(d)

Sol. The Reserve Bank of India levied a ₹2 crore penalty on the **State Bank of India** for violating the Banking Regulation Act, 1949, specifically related to shareholding limits and the Depositor Education Awareness Fund Scheme, 2014.

S60. Ans.(b)

Sol. About the Production Linked Incentive (PLI) Scheme

- The Production Linked Incentive (PLI) Scheme for Automobiles and Auto Components focuses on enhancing the manufacturing of Advanced Automotive Technology (AAT) products in India.
- Its goals include attracting investments in the automotive manufacturing sector and fortifying the value chain associated with this industry.
- The scheme aims to tackle cost-related challenges, foster the development of large-scale operations, and establish a strong supply chain for AAT products.
- This initiative was introduced in the year **2021.**
- A significant budget allocation of **Rs. 25,938 crores** have been earmarked for the implementation of this scheme.
- The scheme targets two main groups as beneficiaries: existing automotive companies and new entrants in the sector.

- It is structured into two distinct segments:
 - The Champion OEM Incentive Scheme is specifically designed for manufacturers of electric and hydrogen fuel cell vehicles.
 - The Component Champions Incentive Scheme focuses on the production of advanced, high-value, and technologically sophisticated automotive components

Recent Amendments-

- The incentive period under this scheme spans five consecutive financial years, commencing from the fiscal year 2023-24.
- The actual disbursement of the incentives will begin in the subsequent financial year, FY 2024-25.
- Eligible companies can avail benefits for five continuous financial years, with the cutoff being the fiscal year ending on March 31, 2028.
- Should an approved company not achieve the required sales growth in the first year, it will forfeit the incentive for that particular year.

S61. Ans.(a)

Sol. The 'SMART 2.0' (Scope for Mainstreaming Ayurveda Research among Teaching Professionals) Program has been initiated by the Ministry of AYUSH. This program is designed to enhance comprehensive clinical research in key sectors of Ayurveda, facilitated through collaboration with Ayurvedic academic institutions and hospitals.

- SMART 2.0 was initiated by the Central Council for Research in Ayurvedic Sciences (CCRAS) in collaboration with the National Commission for Indian System of Medicine.
- The program concentrates on assessing the safety, tolerability, and adherence to Ayurvedic formulations, specifically targeting research in priority areas like Malnutrition, Insufficient lactation, Abnormal Uterine Bleeding, Osteoporosis in post-menopausal women, and Diabetes Mellitus II.
- Under its predecessor, SMART 1.0, approximately 10 diseases were addressed, involving active involvement from teaching professionals across 38 colleges.

S62. Ans.(e)

Sol. Ministry of Health and Family Welfare has achieved milestone of screening more than 1 crore people under the National Sickle Cell Anaemia Elimination Mission.

About National Sickle Cell Anaemia Elimination Mission

- The National Sickle Cell Anaemia Elimination Mission aims to eradicate the genetic transmission of sickle cell anemia by 2047.
- This mission was launched in 2023, starting in Shahdol, Madhya Pradesh.
- As an integral part of the National Health Mission (NHM), it operates in a mission mode, focusing on screening, prevention, and management of sickle cell anemia, particularly in Indian states and union territories where the disease is highly prevalent.
- The National Sickle Cell Anaemia Elimination Mission is focusing on 278 districts that have a high incidence of Sickle Cell Disease (SCD).
- These districts are spread across 17 Indian states, including Gujarat, Maharashtra, Rajasthan, Madhya Pradesh, Jharkhand, Chhattisgarh, West Bengal, Odisha, Tamil Nadu, Telangana, Andhra Pradesh, Karnataka, Assam, Uttar Pradesh, Kerala, Bihar, and Uttarakhand.
- The mission has set a goal to screen approximately 7.0 crore individuals over a three-year period. This screening initiative is planned for the fiscal years 2023-24 through 2025-26.

S63. Ans.(c)

Sol. The National Highways Authority of India (NHAI) has entered into a Memorandum of Understanding with the **National Remote Sensing Centre (NRSC)** under the Indian Space Research Organization (ISRO) for three years to develop and report a "Green Cover Index" for the extensive network of National Highways in India.

- The Memorandum of Understanding (MoU) mandates the National Remote Sensing Centre (NRSC) to perform a detailed, nationwide estimation of green cover along National Highways, termed the "Green Cover Index", utilizing high-resolution satellite imagery.
- This MoU is set for a duration of three years.
- This initiative stems from the Green Highways Policy 2015, under which the Ministry of Road Transport and Highways, along with the NHAI, has emphasized the importance of enhancing greenery along highway corridors.

S64. Ans.(a)

Sol. Union Defence Minister Rajanath Singh has inaugurated India's first all-girls Sainik school – 'Samvid Gurukulam Girls Sainik School' in **Vrindavan, Uttar Pradesh**.

- The primary goal of India's first All-Indian Girls Sainik School is to offer high-quality education and enhanced career opportunities, with a special focus on motivating girls to pursue careers in the Armed Forces.
- The school provides a CBSE curriculum combined with military training for its students.
- It is designed to accommodate 120 students, and admissions will be conducted through a written examination.
- This institution is a key player in advancing the government's initiative to establish 100 new Sainik Schools in various states and union territories, in line with the objectives set out in the National Education Policy 2020.

S65. Ans.(e)

Sol. All are correct

The Ministry of Education has initiated the "**Prerana: An Experiential Learning program**", which is designed to develop leadership skills among its participants.

- The PRERANA Program aims to provide participants with a significant, distinctive, and motivational experience, focusing on nurturing their leadership abilities.
- This program is specifically designed as a week-long residential course for chosen students from class IX to XII.
- Each batch of the program comprises 20 students, with an equal distribution of 10 boys and 10 girls.
- The PRERANA Program will be conducted at a Vernacular School in Vadnagar, Gujarat, which was established in 1888.
- The program's curriculum, centered around nine value-based themes, has been developed by IIT Gandhinagar.
- This initiative integrates the principles of the Indian education system and emphasizes value-based education, aligning with the core tenets of the National Education Policy (NEP) 2020.

S66. Ans.(b)

Sol. The RBI releases the Financial Stability Report (FSR) **biannually**. This frequency allows for a periodic assessment of the financial stability of the banking sector and the broader economy.

S67. Ans.(c)

Sol. As of September 2023, the Scheduled Commercial Banks (SCBs) in India reported a Gross Non-Performing Assets (GNPA) ratio of **3.2%**, marking a significant improvement and indicating a multi-year low in non-performing assets.

S68. Ans.(d)

Sol. The Union Cabinet has approved the overarching scheme "PRITHVI Vigyan (PRITHVI)" of Ministry of Earth Sciences.

- The PRITHVI Scheme aims to enhance and maintain continuous long-term observations across various earth systems including the atmosphere, ocean, geosphere, cryosphere, and solid earth. This is done to monitor the essential indicators of Earth's system and their changes.
- A key objective is to create models for accurately predicting weather, oceanic, and climate-related hazards, as well as to deepen the understanding of climate change science.
- The scheme also focuses on exploring the Earth's polar regions and high seas to uncover new phenomena and resources.
- Another important goal is to advance technologies for the exploration and sustainable exploitation of ocean resources, aimed at benefiting societal needs.

About PRITHVI Scheme

- The PRITHVI Scheme is set for a period from 2021 to 2026.
- The total budget allocated for this scheme is Rs. 4,797 crores.
- This comprehensive scheme includes five ongoing sub-schemes:
 - Atmosphere & Climate Research-Modelling Observing Systems & Services (ACROSS),
 - Ocean Services, Modelling Application, Resources and Technology (O-SMART),
 - Polar Science and Cryosphere Research (PACER),
 - Seismology and Geosciences (SAGE),
 - **Research, Education, Training and Outreach (REACHOUT).**

S69. Ans.(e)

Sol. Ministry of Environment, Forests and Climate Change has submitted three nominations from India for Wetland City Accreditation (WCA) under the Ramsar Convention on Wetlands.

The first three Indian cities nominated for the WCA are:

- **Indore**, located in Madhya Pradesh
- **Bhopal**, also in Madhya Pradesh
- **Udaipur** in Rajasthan
 - The Wetland City Accreditation aims to encourage the preservation and judicious utilization of wetlands, while also ensuring sustainable socio-economic advantages for local communities.
 - This program is a voluntary accreditation system that acknowledges the significance of wetlands in urban and peri-urban areas.
 - The accreditation was established during the 12th Conference of the Parties (COP12) of the Ramsar Convention in 2015.
 - The accreditation process is based on six specific criteria, which include the existence of Ramsar sites or other wetland conservation areas within the city.
 - Once awarded, the accreditation remains valid for six years.

S70. Ans.(c)

Sol. The 'Payments' sub-indicator in the D-SIB assessment methodology has been revised from "Payments in INR via RTGS and NEFT" to **75% weightage on the total value and 25% on the total volume of Digital Payments**. This revision reflects the evolving nature of digital payments in the banking sector.

S71. Ans.(e)

Sol. None of the above is incorrect, as all the given statements are correct.

The New Swarnima Scheme for Women:

Objectives:

- To foster self-reliance among women from Backward Classes through term loans.

Eligibility:

- Women belonging to Backward Classes, as identified by the Central/State Governments, are eligible for loans under this scheme.
- The applicant's annual family income should not exceed Rs. 3.00 Lakh.

Salient Features:

- The New Swarnima scheme primarily targets women from Backward Classes with an annual family income of less than Rs. 3.00 Lakh.
- Beneficiary women are not required to make any personal investment for projects up to a cost of Rs. 2,00,000/-.
- The interest rate on the loan is lower compared to the Corporation's general loan scheme.

Maximum Loan Amount: Rs. 2.00 Lakh (per beneficiary)

Pattern of Financing:

- NBCFDC Loan: 95%
- Channel Partner Contribution: 5%

Rate of Interest:

- From NBCFDC to Channel Partner: 2% per annum
- From Channel Partner to the beneficiary: 5% per annum

Repayment:

- The loan is to be repaid in quarterly installments over a maximum period of 8 years, including a six-month moratorium on principal recovery.

S72. Ans.(e)

Sol. In January 2024, Jal Jeevan Mission (JJM) has crossed milestone of providing tap water connections to 14 Crore (72.71%) rural households since its launch in 2019.

Six states and three UTs have achieved 100% coverage:

- **States:** Goa, Telangana, Haryana, Gujarat, Punjab, and Himachal Pradesh
- **UTs:** Puducherry, D&D and D&NH, and A&N Islands

S73. Ans.(b)



Sol. Middle-layer non-bank financial companies (NBFC-ML) have been permitted by RBI to utilize credit risk transfer instruments for calculating their exposures.

S74. Ans.(b)

Sol. New exemptions from credit concentration norms include **exposures fully guaranteed by the Government of India**, as per the latest RBI directives for NBFCs.

S75. Ans.(e)

Sol. The Ministry of Sports and Youth Affairs implements the scheme of 'Pandit Deendayal Upadhyay National Welfare Fund for Sportspersons' (PDUNWFS) with the objectives to provide suitable assistance to outstanding sportspersons now living in indigent circumstances, to provide suitable assistance to outstanding sportspersons injured during the period of their training for competitions and also during the competitions, depending on the nature of the injury, to provide suitable assistance to sportspersons for medical treatment, to provide suitable assistance to promote the welfare of sportspersons generally to alleviate distress among them and their dependents in indigent circumstances, and to provide assistance to sportspersons living in indigent circumstances for training, procurement for sports equipment, participation in national and international sports events, etc.

Financial assistance up to **Rs. 5.00 Lakh** for outstanding sportspersons living in indigent circumstances and up to **Rs. 10.00 Lakh** for medical treatment to sportspersons or family members is provided under the scheme of PDUNWFS.

S76. Ans.(c)

Sol. The **SVAMITVA Scheme** received the Best Innovation Award at the Public Policy Dialogue-2024, recognizing its innovative approach in the Innovation Sandbox Presentation, an event organized by the Indian School of Business in Hyderabad.

About SVAMITVA Scheme

- The SVAMITVA Scheme aims to issue 'Record of Rights' to households owning properties in the inhabited areas (Abadi) of villages.
- This scheme was initiated in the year 2021.
- It is under the purview of the Ministry of Panchayati Raj.
- The scheme is classified as a Central Sector Scheme and is entirely funded by the central government.
- The targeted year for completing the implementation of this scheme is set for 2024-25.
- The SVAMITVA Scheme involves the use of advanced drone surveys and GIS mapping technology to survey land parcels in the rural inhabited areas of villages.
- This approach ensures precise demarcation of land parcels, leading to the issuance of SVAMITVA Property Cards. These cards provide individuals with accurate property records, clarifying property ownership.
- The SVAMITVA Scheme aids in the monetization of properties, thereby simplifying the process of obtaining bank loans and reducing disputes related to property.
- Additionally, it contributes to thorough village-level planning.
- The scheme also lays the groundwork for property tax assessment. The revenue generated from this tax directly benefits the Gram Panchayats in states where such authority is devolved.

Implementation: It is being implemented with the collaborative efforts of the Ministry of Panchayati Raj, Survey of India (SoI), State Revenue Department, State Panchayati Raj Department and National Informatics Centre.

Additional Info-

- The SVAMITVA Scheme was awarded the Gold Prize at the National Awards for e-Governance 2023. This accolade was received in the category of "Use of Emerging Technology for Providing Citizen-Centric Services."
- This award was presented by the Ministry of Personnel, Public Grievances and Pensions in Indore, Madhya Pradesh, in October 2023.
- Additionally, the scheme secured a gold award in the category of "Innovative Use of Technology in e-Governance for Digital Transformation" at the Digatech Conclave 2023. This event was held in Goa in August 2023.

S77. Ans.(d)

Sol.

- The Expert Committee is made up of **13 members**.
- The leadership of the committee is under the IRDAI Member (Finance and Investment) F&I.

Key committee members are:

- The Chairman of the Accounting Standards Board (ASB) of the Institute of Chartered Accountants of India (ICAI).
- The President of the Institute of Actuaries of India (IAI).
- The Chief General Manager (CGM) & Head of Department (HOD) of the Actuarial Department at IRDAI.

S78. Ans.(b)

Sol. The theme of Swachh Survekshan 2023 was "**Waste to Wealth**," emphasizing the conversion of waste materials into useful resources as a part of the urban sanitation and cleanliness initiative.

S79. Ans.(d)

Sol. The **exchange rate** refers to the price or value at which one currency can be exchanged for another currency. It represents the rate at which currencies are traded in the foreign exchange market.

S80. Ans.(e)

Sol. Statements B & C are correct while statement A is incorrect as

- The scheme was launched on **9th May 2015** by Prime Minister Narendra Modi to deliver old-age income security to all citizens of India, particularly to the workers in the unorganized sector.

Details:

- Atal Pension Yojana (APY), the Government of India's flagship social security scheme, has completed eight years of successful implementation.
- A new APY account can be opened by any Indian citizen, in the age group of 18-40 years, who is having a savings bank account and who is not an income taxpayer.
- Under APY, a subscriber would receive a lifelong minimum guaranteed pension of Rs.1000 to Rs.5000 per month from the age of 60 years, depending on their contributions, which itself would vary based on the age of joining the APY scheme.
- The same pension would be paid to the spouse of the subscriber after the demise of the subscriber and on the demise of both the subscriber and spouse, the pension wealth as accumulated till age 60 of the subscriber would be returned back to the nominee.

S81. Ans.(a)

Sol. The correct answer is "**Word decoding deficits can hinder reading fluency and comprehension in individuals with ADHD.**"

This option accurately reflects the information provided in the passage. It states that individuals with ADHD often experience difficulties in decoding written words, which can impede their ability to read fluently and comprehend the text.

The incorrect options are:

(b) "Lack of interest in reading can negatively impact reading comprehension in individuals with ADHD." While lack of interest in reading may be a potential issue for some individuals with ADHD, it is not identified as a significant factor contributing to reading comprehension difficulties in the passage.

(c) "Impaired vision can affect reading and comprehension abilities in individuals with ADHD." Although impaired vision can certainly impact reading and comprehension abilities, the passage does not mention it as a significant factor specifically in individuals with ADHD.

(d) "Limited vocabulary can pose challenges for reading and understanding text in individuals with ADHD." While limited vocabulary can be a general reading challenge, the passage does not specifically highlight it as a significant factor contributing to reading comprehension difficulties in individuals with ADHD.

(e) "Excessive attention to details may impede overall comprehension in individuals with ADHD." While excessive attention to details may have implications for overall comprehension, the passage does not discuss it as a specific factor contributing to reading comprehension difficulties in individuals with ADHD.

S82. Ans.(b)

Sol. The correct answer is "**It involves a dysfunction that disrupt the brain's ability to control thoughts and behavior.**"

This factor refers to the deficit in executive functioning that individuals with ADHD experience. Executive functioning involves cognitive processes such as attention, working memory, cognitive flexibility, and impulse control, which are crucial for effective learning and academic performance.

The incorrect options are:

(a) "It includes a chronic problem in which people lack the ability to maintain self-control": This option is as the option suggests that academic struggles in individuals with ADHD are primarily due to a chronic problem in maintaining self-control which is associated with ADHD. While self-control can be a common challenge for individuals with ADHD, it is not the primary factor underlying their academic struggles. The deficit in executive functioning, which affects various aspects of cognitive control and organization, is the key contributor to academic difficulties in ADHD.

(c) **“It comprises the inability to sleep with a balanced circadian cycle”**: This option is incorrect as the option states that academic struggles in individuals with ADHD are contributed by the inability to sleep with a balanced circadian cycle. However, this option is incorrect and not directly related to academic struggles in individuals with ADHD.

(d) **“It involves procrastination which can lead to negative mood and emotions”**: The incorrect option implies that procrastination is a significant factor contributing to academic struggles in individuals with ADHD. While procrastination can be a common challenge for individuals with ADHD, it is not the primary factor underlying their academic struggles. The deficit in executive functioning, which affects various aspects of cognitive control and organization, is the key contributor to academic difficulties in ADHD.

(e) **“It includes the inability to understand and adapt the social behaviour during an interaction”**: The incorrect option suggests that academic struggles in individuals with ADHD stem from an inability to understand and adapt social behaviour during interactions. While social difficulties can co-occur with ADHD, they are not the primary cause of academic struggles. The deficit in executive functioning, which affects cognitive processes related to attention, organization, and self-regulation, is the primary factor contributing to academic challenges in individuals with ADHD.

S83. Ans.(a)

Sol. The correct answer is **“Central ideas have more connections to other ideas and are crucial to understanding the overall message, while peripheral ideas have fewer connections and are considered less important.”**

In the passage, it is stated that central ideas, which have the most connections to other ideas in the passage, are crucial to understanding the overall message. This implies that central ideas play a significant role in conveying the main point or theme of the passage. On the other hand, peripheral ideas, which have fewer connections, are considered less important in the context of the passage.

The incorrect options are:

(b) **Central ideas have fewer connections and are considered less important, while peripheral ideas have more connections and are crucial to understanding the overall message**: This contradicts the information provided in the passage, which states that central ideas have more connections and are crucial.

(c) **Central ideas and peripheral ideas have equal importance in understanding the overall message of a passage**: This contradicts the idea presented in the passage that central ideas are more important than peripheral ideas due to their greater number of connections.

(d) **Central ideas and peripheral ideas have no impact on understanding the overall message of a passage**: This contradicts the information provided in the passage, which clearly states that central ideas are crucial to understanding the overall message.

(e) **The importance of central ideas and peripheral ideas varies depending on the specific passage being read**: While the importance may vary in different passages, the given passage specifically emphasizes the significance of central ideas having more connections and being crucial to understanding the overall message. Thus, this option does not accurately reflect the information provided in the passage.

S84. Ans.(a)

Sol. The correct answer is **“Individuals with ADHD often experience difficulty sustaining attention, which can significantly impact their academic performance.”**

This option directly addresses the question by explaining that the transient nature of auditory information poses challenges for individuals with ADHD due to their difficulty in sustaining attention.

The incorrect statements are:

(b) **“Individuals with ADHD may exhibit a range of learning preferences, and being more visually-oriented learners is one possible trait.”** This option is not directly related to the transient nature of auditory information and does not address the challenges posed by it.

(c) **“Some individuals with ADHD may struggle with reading comprehension due to their critical state of short-term memory.”** This option does not specifically address the transient nature of auditory information.

(d) **“Conduct disorder is typically associated with ADHD as it primarily involves difficulties in attention and impulse control.”** This option is unrelated to the transient nature of auditory information.

(e) **“Some individuals with ADHD may show a preference for visual stimuli over auditory stimuli, which may influence their learning style and engagement.”** This option also does not directly address the challenges posed by the transient nature of auditory information.

S85. Ans.(a)

Sol. The correct answer is “**Individuals with ADHD may struggle with recalling information accurately.**”

According to the passage his option is correct. ADHD can affect working memory and attention, making it challenging for individuals to remember and accurately recall information they have heard.

The incorrect options are:

(b) Individuals with ADHD manifest challenges with spelling: This option is incorrect. Individual with ADHD do not find any difficulty in manifesting spellings.

(c) Inability to identify and manipulate the sounds in spoken language: This option is incorrect with the reference to the questions asked.

(d) Individuals with ADHD stumble over words while reciting the information of the comprehension: This option is incorrect. There is no information provided to support the given option.

(e) Inferring implicit meanings can be challenging for individuals with ADHD: This option is incorrect. There is no information provided to support the given option.

S86. Ans.(d)

Sol. The correct synonym of the word “**explicit**” is “**specific**”.

The word “**specific**” in the passage refers to something that is clear, definite, or precise. In this context, “**explicit**” is a synonym that accurately captures the meaning of “specific.” When something is explicit, it is clearly stated or expressed, leaving no room for ambiguity or confusion.

In the given passage, the author discusses the nature of comprehension difficulties experienced by individuals with ADHD. The author mentions that little is known about the specific nature of these challenges, indicating the need for precise understanding. Therefore, “explicit” aligns well with the intended meaning in this context.

The incorrect options are:

(a) general: This option is incorrect. “General” is an antonym of “specific,” as it refers to something that is broad or nonspecific.

(b) typical: This option is incorrect. “Typical” refers to something that is characteristic or usual, but it is not a synonym for “specific.”

(c) rumple: This option is incorrect. “Rumple” means to wrinkle or disarrange, and it is not a synonym for “specific.”

(d) explicit: This option is correct. “Explicit” means clear, definite, or specific in terms of details or information. It is a synonym of “specific” in the given context.

(e) disarray: This option is incorrect. “Disarray” means disorder or confusion, and it is not a synonym for “specific.”

S87. Ans.(e)

Sol. The correct antonym of the word “**coherence**” is “**tension**”.

The word “coherence” in the passage refers to the quality of being logical, consistent, and interconnected. It implies a sense of unity and flow in the ideas or information being presented. An antonym is a word that has the opposite meaning of the given word.

Among the options provided, “tension” stands out as the antonym of “coherence.” While coherence represents a harmonious and organized state, tension implies a state of conflict, strain, or disruption. These two words are contrasting in their meaning, making “tension” the appropriate antonym for “coherence” in this context.

The incorrect options are:

(a) “Suspends” means to temporarily stop or postpone something. It does not provide an opposite meaning to “coherence.”

(b) “Banishes” means to send away or get rid of someone or something. It does not convey the opposite meaning of “coherence.”

(c) “Excludes” means to deliberately leave out or not include something. While it is not directly opposite to “coherence,” it does not represent the opposite meaning.

(d) “Prevents” means to stop something from happening or to hinder its occurrence. It does not convey the opposite meaning of “coherence.”

S88. Ans.(d)

Sol. The correct to fit in the blank appropriately is “**contributes**”.

In the passage, it is mentioned that the combination of challenges, such as decoding deficits in reading and difficulties in higher-order language processes and organization in listening, is linked to the academic struggles experienced by individuals with ADHD. The word “contributes” accurately conveys the idea that these factors play a role in causing or adding to the academic difficulties. It suggests a causal relationship between the mentioned challenges and the struggles faced by individuals with ADHD.

The incorrect options are:

(b) “Stings” implies a negative or painful impact, which is not necessarily indicated in the passage.

(c) “Spares” means to save or exempt, which is not in line with the idea of contributing to academic struggles.

(d) “Leverage” means to use or exploit, which does not align with the concept of challenges causing struggles.

(e) “Correlates” indicates a relationship or connection between two variables, but it does not specifically convey the idea of challenges leading to academic struggles.

S89. Ans.(b)

Sol. The correct synonym of the word “**established**” is “**determinate**”.

The word "established" in the passage implies something that has been firmly or definitively set up or confirmed. A synonym for "established" is "determinate," which means precisely determined or fixed.

The incorrect options are:

(a) collection: This option is incorrect. "Collection" refers to the act of gathering or assembling things together, which is the opposite of dispersion.

(c) dissipation: This option is incorrect. "Dissipation" means the act of disappearing or dissipating gradually, which is not synonymous with dispersion.

(d) concentration: This option is incorrect. "Concentration" refers to the act of gathering or bringing together in a focused manner, which is the opposite of dispersion.

S90. Ans.(a)

Sol. The correct answer is “**strengthen**”.

"strengthen" is the appropriate choice here. After breaking her ankle, Angie needs to attend therapy to build up the strength in her ankle, as well as facilitate the healing and repair process. Strengthening exercises and treatments are often part of rehabilitation therapy after an injury.

Thus, the correct sentence formed will be “After breaking her ankle, Angie had to attend therapy to **strengthen** and repair it.”

The incorrect options are:

(b) ensure: This option is incorrect. While it is important to ensure proper healing and recovery, the sentence structure doesn't convey the idea that Angie needs to attend therapy in order to ensure her ankle is repaired.

(c) condition: This option is incorrect. "Condition" refers to preparing or conditioning the ankle, but it doesn't capture the full context of therapy required for healing and repair.

(d) initial: This option is incorrect. "Initial" suggests the beginning or first stage, but it doesn't convey the ongoing process of therapy that Angie needs to undergo for her ankle.

(e) liberal: This option is incorrect. "Liberal" refers to a generous or unrestricted approach, which doesn't align with the specific and targeted nature of therapy required for Angie's ankle.

S91. Ans.(c)

Sol. The correct answer is “**craving**”.

"craving" is the appropriate choice here. During pregnancy, it is common for women to experience strong desires or longings for specific foods or combinations of foods. This is often referred to as food cravings. In this context, the woman has a persistent and strong desire for pickles and ice cream.

Thus, the correct sentence formed will be “The pregnant woman had a constant **craving** for pickles and ice cream.”

The incorrect options are:

(a) composition: This option is incorrect. "Composition" refers to the structure or arrangement of something, such as a piece of music or a written work. It does not convey the idea of a strong desire for specific food items.

(b) fettle: This option is incorrect. "Fettle" refers to a person's physical condition or state of health. While it could be relevant in the context of pregnancy, it does not specifically capture the idea of a craving for pickles and ice cream.

(d) voyage: This option is incorrect. "Voyage" refers to a journey or trip, typically involving travel by sea or through unknown territories. It does not relate to the strong desire or craving mentioned in the sentence.

(e) wander: This option is incorrect. "Wander" means to move about without a specific destination or purpose. It does not convey the idea of a craving or desire for pickles and ice cream.

S92. Ans.(d)

Sol. The correct answer is “**misconceived**”.

"misconceived" is the appropriate choice here. It means that the readers misunderstood or formed incorrect interpretations of the meaning of the poet's latest piece. The frustration of the poet arises from the fact that the readers' understanding or perception of the poem was not aligned with the intended meaning.

Thus, the correct sentence formed will be “The poet was frustrated that so many of the readers were confused and **misconceived** the meaning of her latest piece.”

The incorrect options are:

(a) reinforce: This option is incorrect. "Reinforce" means to strengthen or support, but it does not convey the idea of readers misunderstanding the meaning of the poem.

(b) fortify: This option is incorrect. "Fortify" means to strengthen or make stronger, but it does not accurately describe the readers' confusion or incorrect interpretation of the poem.

(c) anneal: This option is incorrect. "Anneal" means to heat and then cool a material to reduce its brittleness, but it does not relate to the confusion or misunderstanding of the readers.

(e) inure: This option is incorrect. "Inure" means to accustom or become accustomed to something unpleasant or difficult, but it does not capture the idea of readers misconceiving the meaning of the poem.

S93. Ans.(b)

Sol. The correct answer is "aggregate".

"aggregate" is the appropriate choice here. It means to gather or collect things together into a whole. In the context of the mobile game, users are required to group or combine balls of the same color in order to complete a task or achieve a goal, which is to save baby pandas.

Thus, the correct sentence formed will be "The mobile game calls upon users to **aggregate** balls by colour in order to save baby pandas."

The incorrect options are:

(a) preserve: This option is incorrect. "Preserve" means to protect or keep something in its original state. While saving baby pandas may involve preservation efforts, it does not accurately convey the specific action of aggregating balls by colour in the game. This option is grammatically incorrect.

(c) scant: This option is incorrect. "Scant" means to have a small or insufficient amount of something. It does not relate to the action of aggregating balls by color.

(d) disastrous: This option is incorrect. "Disastrous" means causing great damage or destruction. It does not fit the context of the sentence, which focuses on the game's objective of saving baby pandas by grouping balls by colour.

(e) inferior: This option is incorrect. "Inferior" means of lower quality or value. It does not accurately convey the action of aggregating balls by color or the purpose of saving baby pandas in the game.

S94. Ans.(a)

Sol. The correct answer is "through".

"Through" indicates that the aroma of street food is spreading or permeating the air, creating a tantalizing scent that can be perceived by people.

Thus, the correct sentence formed will be "The tantalizing aroma of street food wafts **through** the air, enticing hungry wanderers."

The incorrect options are:

(b) until: This option is incorrect. "Until" implies a temporal limit or endpoint, which doesn't fit well in the context of describing the aroma of street food spreading through the air.

(c) on: This option is incorrect. "On" suggests a physical contact or attachment, which doesn't convey the idea of the aroma spreading through the air.

(d) to: This option is incorrect. "To" implies a direction or target, but it doesn't effectively convey the idea of the aroma spreading or wafting through the air.

(e) beside: This option is incorrect. "Beside" suggests a physical location or proximity, which doesn't effectively describe the aroma of street food spreading through the air.

S95. Ans.(b)

Sol. The correct answer is "as".

"as" is the appropriate choice here. It is used to indicate a reason or cause. In this context, it explains that the serving trays appeared indestructible because they had successfully endured numerous family dinners over many decades. The word "as" establishes a cause-and-effect relationship between the trays' durability and their ability to withstand the passage of time.

Thus, the correct sentence formed will be "The serving trays in her grandmother's kitchen seemed indestructible **as** they had made it through decades of family dinners."

The incorrect options are:

(a) through: This option is incorrect in this context. "Through" indicates a passage or movement from one side to another, but it doesn't fit well in the sentence structure or convey the intended meaning of contrast or cause.

(c) on the other hand: This option is incorrect. "On the other hand" is a phrase used to introduce a contrasting point or perspective, but it doesn't fit well in this sentence structure. It doesn't effectively explain the relationship between the indestructible appearance of the trays and their endurance over time.

(d) along: This option is incorrect. "Along" suggests a sense of movement or progression, but it doesn't convey the intended contrast or cause in this context.

(e) while: This option is incorrect. "While" is used to indicate a concurrent action or a contrast between two events happening at the same time, but it doesn't effectively convey the cause-and-effect relationship between the trays' durability and their endurance over time.

S96. Ans.(d)

Sol. The correct answer is "since".

"since" is the appropriate choice here. It is used to indicate a cause or reason. In this context, it explains that the reason why Fred was indistinguishable to his classmates was because his twin brother was standing next to him. The word "since" establishes a cause-and-effect relationship between the presence of his twin brother and Fred's lack of distinctiveness. Thank you for pointing out the correct answer.

Thus, the correct sentence formed will be "Fred was indistinguishable to his classmates **since** his twin brother was standing next to him."

The incorrect options are:

(a) along: This option is incorrect. "Along" suggests movement or progression, but it doesn't fit well in the sentence structure or convey the intended meaning of cause or reason.

(b) to: This option is incorrect. "To" indicates direction or purpose, but it doesn't effectively convey the cause-and-effect relationship between Fred's indistinguishability and the presence of his twin brother.

(c) until: This option is incorrect. "Until" indicates a temporal limit or endpoint, which doesn't fit well in the context of explaining the cause of Fred's indistinguishability.

(e) besides: This option is incorrect. "Besides" indicates an additional piece of information or exception, but it doesn't fit well in the sentence structure or convey the intended cause-and-effect relationship between Fred's indistinguishability and his twin brother's presence.

S97. Ans.(e)

Sol. The correct answer is "under".

"under" is the appropriate choice here. It is used to indicate the circumstances or framework in which something occurs. In this context, it specifies that the clause in the contract outlines the specific conditions or circumstances that would lead to the termination of the agreement. The word "under" establishes the relationship between the conditions and the termination of the agreement. Thank you for pointing out the correct answer.

Thus, the correct sentence formed will be "The contract includes a clause outlining the conditions **under** which the agreement can be terminated."

The incorrect options are:

(a) to: This option is incorrect because "to" is a preposition that typically indicates direction, purpose, or result. In this context, it doesn't fit well to convey the intended meaning of outlining the conditions.

(b) along: This option is incorrect because "along" is an adverb or preposition that generally indicates movement or progression. It doesn't appropriately convey the idea of outlining the conditions for terminating the agreement.

(c) through: This option is incorrect because "through" is a preposition that often indicates movement from one side to another or completion of a process. It doesn't accurately convey the intended meaning of outlining the conditions.

(d) that: This option is incorrect because "that" is a relative pronoun used to introduce a subordinate clause, providing additional information or specifying a particular thing. However, it doesn't effectively establish the relationship between the main and subordinate clauses in the given sentence.

S98. Ans.(c)

Sol. The correct answer is “**that**”.

“that” is the appropriate choice here. It is used as a conjunction to introduce a subordinate clause that provides additional information or specifies a particular thing. In this context, “that” connects the main clause (“The company’s quality control measures ensure”) with the subordinate clause (“all products meet industry standards”). It clarifies the purpose or function of the quality control measures in relation to meeting industry standards.

Thus, the correct sentence formed will be “The company’s quality control measures ensure **that** all products meet industry standards before they are shipped to customers.”

The incorrect options are:

(a) since: This option is incorrect. “Since” is a conjunction used to indicate a cause or reason. However, in this sentence, there is no cause-and-effect relationship being expressed. Instead, the emphasis is on the assurance that all products meet industry standards.

(b) whereas: This option is incorrect. “Whereas” is a conjunction used to introduce a contrasting clause or statement. However, there is no contrast being made in this sentence. The focus is on the company’s quality control measures and their role in ensuring that all products meet industry standards.

(d) from: This option is incorrect. “From” is a preposition used to indicate a point of origin or separation. However, in this context, it does not fit well with the intended meaning of ensuring that all products meet industry standards.

(e) to: This option is incorrect. “To” is a preposition used to indicate direction or purpose. However, it does not effectively convey the idea of quality control measures ensuring that all products meet industry standards.

S99. Ans.(c)

Sol. The misspelt word in the sentence is “**consequencses**” as the right spelling is “**consequences**”.

(a) conspiring: This refers to the act of planning or plotting secretly and often unlawfully with others to do something, especially something harmful or illegal. It involves a group of individuals working together in a clandestine manner to achieve a particular goal.

(b) illegal: This term describes something that is prohibited by law, not allowed, or contrary to the legal regulations in place. Actions or behaviours that are illegal can result in legal consequences, such as fines, penalties, or even criminal charges.

(c) consequences: This refers to the results, effects, or outcomes of a particular action, event, or decision. Consequences can be positive or negative, and they often follow from the choices we make. They can include both immediate and long-term impacts on individuals, groups, or situations.

(d) commit: This word has multiple meanings depending on the context. In a general sense, “commit” means to carry out or perform an action.

S100. Ans.(e)

Sol. All the given spellings in the sentence are correct.

The context of the sentence is observing the interaction between a cat and a dog while they are playing together. The speaker finds this sight comforting because it reassures them that animals from different species can live together harmoniously.

S101. Ans.(a)

Sol. The correct answer is **ACBD**

The context of the sentence is centred around a person who possesses a strong and steadfast resolve to chase their aspirations. Despite facing various difficulties and obstacles along the way, this individual remains resolute and determined. They display an **unwavering** (continuing in a strong and steady way) commitment to their dreams, refusing to let setbacks or hardships deter them from their path. This context highlights the person’s perseverance, resilience, and refusal to abandon their goals, serving as an inspiring example of dedication in the face of adversity.

The correct sentence formed will be “With **unwavering** determination, she **pursued** her dreams, **refusing** to give up **despite** the challenges.”

S102. Ans.(c)

Sol. The correct answer is **BDCA**.

The context of the sentence portrays a scene where the enchanting sound of a piano fills the air with **melodious** (a sweet or agreeable succession or arrangement of sounds) notes. The music emanating from the instrument carries a certain power, capable of evoking deep emotions within those who listen. The sentence emphasizes the idea that the emotions stirred by the music are so profound and indescribable that no words can fully capture or express them.

The correct sentence formed will be “The **melodious** notes of the piano **danced** in the air, **evoking** emotions that words could never **express**.”

S103. Ans.(d)**Sol.** The correct answer is **CADB**.

The context of the sentence depicts a peaceful setting in a **serene** (marked by or suggestive of utter calm) meadow. The atmosphere is calm and **tranquil** (free from agitation of mind or spirit), with gentle breezes rustling through the tall grass. The soft whispers of the breeze blend harmoniously with the natural surroundings, creating a symphony of tranquillity that resonates throughout the meadow. The sentence emphasizes the serene beauty of nature, where even the subtlest elements, like the gentle breeze, contribute to a sense of peace and harmony.

The correct sentence formed will be "In the **serene** meadow, the soft breeze **whispered** through the tall grass, creating a **tranquil** symphony of nature's **peace**."

S104. Ans.(b)**Sol.** The correct answer is **ABDC**.

The context of the sentence revolves around a detective who is actively investigating a complex case. As the detective delves deeper into their investigation, they begin unravelling a network of intricate and puzzling connections. Each clue they uncover serves as a breadcrumb, guiding them closer to unravelling the truth behind the crime. The sentence highlights the detective's meticulous work and determination, as they navigate through the web of intrigue and mystery, steadily piecing together the puzzle.

Intrigue: to arouse the interest, desire, or curiosity

The correct sentence formed will be "The detective **uncovered** a web of **intrigue** and mystery, each clue leading them **closer** to the truth behind the **crime**."

S105. Ans.(e)**Sol.** The correct answer is no rearrangement required as the given sentence is correct.

The context of the sentence portrays a scene during night time when the sky is filled with an abundance of stars. The sentence describes the captivating sight of the night sky, where the stars shine with a radiant and luminous brilliance. The stars' luminosity casts a magical aura over the Earth below, captivating observers with their enchanting beauty.

Aglow: glowing especially with warmth or excitement**Luminous:** emitting or reflecting usually steady or glowing light

The correct sentence formed will be "The **night** sky was **aglow** with countless stars, their **luminous** brilliance casting a **magical** spell on the Earth below."

S106. Ans.(e)**Sol.** The second statement after rearrangement is "E".

(D) Dehydration is a critical condition resulting from an inadequate intake of fluids or excessive loss of water from the body. This sentence introduces the topic and defines dehydration.

(E) It occurs when the body's water levels drop below the required amount for optimal function. This sentence explains the underlying cause of dehydration, which is the insufficient water levels in the body.

(C) Dehydration can manifest through various symptoms such as dry mouth, thirst, dizziness, fatigue, and dark-coloured urine. This sentence provides examples of common symptoms associated with dehydration, helping to illustrate its effects.

(A) It not only affects physical performance but also impacts mental acuity and overall well-being. This sentence highlights that dehydration has consequences beyond physical performance, including its impact on mental sharpness and overall health.

(B) Without prompt intervention, severe dehydration can lead to organ failure and even be life-threatening. This sentence emphasizes the severity of dehydration if left untreated, stressing the importance of timely intervention to prevent organ failure and potentially fatal outcomes.

Thus, the correct sequence of the statements after rearrangement is "DECAB".

S107. Ans.(b)**Sol.** The first statement after rearrangement is "D".

(D) Dehydration is a critical condition resulting from an inadequate intake of fluids or excessive loss of water from the body. This sentence introduces the topic and defines dehydration.

(E) It occurs when the body's water levels drop below the required amount for optimal function. This sentence explains the underlying cause of dehydration, which is the insufficient water levels in the body.

(C) Dehydration can manifest through various symptoms such as dry mouth, thirst, dizziness, fatigue, and dark-coloured urine. This sentence provides examples of common symptoms associated with dehydration, helping to illustrate its effects.

(A) It not only affects physical performance but also impacts mental acuity and overall well-being. This sentence highlights that dehydration has consequences beyond physical performance, including its impact on mental sharpness and overall health.

(B) Without prompt intervention, severe dehydration can lead to organ failure and even be life-threatening. This sentence emphasizes the severity of dehydration if left untreated, stressing the importance of timely intervention to prevent organ failure and potentially fatal outcomes.

Thus, the correct sequence of the statements after rearrangement is “DECAB”.

S108. Ans.(c)

Sol. The fourth statement after rearrangement is “A”.

(D) Dehydration is a critical condition resulting from an inadequate intake of fluids or excessive loss of water from the body. This sentence introduces the topic and defines dehydration.

(E) It occurs when the body's water levels drop below the required amount for optimal function. This sentence explains the underlying cause of dehydration, which is the insufficient water levels in the body.

(C) Dehydration can manifest through various symptoms such as dry mouth, thirst, dizziness, fatigue, and dark-coloured urine. This sentence provides examples of common symptoms associated with dehydration, helping to illustrate its effects.

(A) It not only affects physical performance but also impacts mental acuity and overall well-being. This sentence highlights that dehydration has consequences beyond physical performance, including its impact on mental sharpness and overall health.

(B) Without prompt intervention, severe dehydration can lead to organ failure and even be life-threatening. This sentence emphasizes the severity of dehydration if left untreated, stressing the importance of timely intervention to prevent organ failure and potentially fatal outcomes.

Thus, the correct sequence of the statements after rearrangement is “DECAB”.

S109. Ans.(b)

Sol. The fifth statement after rearrangement is “B”.

(D) Dehydration is a critical condition resulting from an inadequate intake of fluids or excessive loss of water from the body. This sentence introduces the topic and defines dehydration.

(E) It occurs when the body's water levels drop below the required amount for optimal function. This sentence explains the underlying cause of dehydration, which is the insufficient water levels in the body.

(C) Dehydration can manifest through various symptoms such as dry mouth, thirst, dizziness, fatigue, and dark-coloured urine. This sentence provides examples of common symptoms associated with dehydration, helping to illustrate its effects.

(A) It not only affects physical performance but also impacts mental acuity and overall well-being. This sentence highlights that dehydration has consequences beyond physical performance, including its impact on mental sharpness and overall health.

(B) Without prompt intervention, severe dehydration can lead to organ failure and even be life-threatening. This sentence emphasizes the severity of dehydration if left untreated, stressing the importance of timely intervention to prevent organ failure and potentially fatal outcomes.

Thus, the correct sequence of the statements after rearrangement is “DECAB”.

S110. Ans.(d)

Sol. The correct sequence of statements after rearrangement is “DECAB”.

(D) Dehydration is a critical condition resulting from an inadequate intake of fluids or excessive loss of water from the body. This sentence introduces the topic and defines dehydration.

(E) It occurs when the body's water levels drop below the required amount for optimal function. This sentence explains the underlying cause of dehydration, which is the insufficient water levels in the body.

(C) Dehydration can manifest through various symptoms such as dry mouth, thirst, dizziness, fatigue, and dark-coloured urine. This sentence provides examples of common symptoms associated with dehydration, helping to illustrate its effects.

(A) It not only affects physical performance but also impacts mental acuity and overall well-being. This sentence highlights that dehydration has consequences beyond physical performance, including its impact on mental sharpness and overall health.

(B) Without prompt intervention, severe dehydration can lead to organ failure and even be life-threatening. This sentence emphasizes the severity of dehydration if left untreated, stressing the importance of timely intervention to prevent organ failure and potentially fatal outcomes.

Thus, the correct sequence of the statements after rearrangement is “DECAB”.

S111. Ans.(c)

Sol.

Total selling price of mixture = $(160 + Q) \times 48$

And, total cost price of milk = 160×48

\therefore ATQ

$$\frac{(160+Q) \times 48 - 160 \times 48}{160 \times 48} \times 100 = 25$$

$$\frac{160+Q-160}{160} \times 100 = 25$$

$$Q = 40$$

So, value of $(Q + 8) = 40 + 8 = 48$

S112. Ans.(d)

Sol.

Total amount got Khushi = $8000 \left(1 + \frac{20}{100}\right)^2 = \text{Rs. } 11,520$

So, C.I. = $11520 - 8000 = \text{Rs. } 3520$

Let the money added Rs. Y

ATQ.

$$(8000 + Y) \times \frac{21}{100} - 3520 = 3410$$

$$\frac{21Y}{100} = 3410 + 3520 - 1680$$

$$\frac{21Y}{100} = 5250$$

$$Y = \text{Rs. } 25000$$

S113. Ans.(d)

Sol.

Amount spent in a month of August = **Rs.28000**

Amount spent in a month of May = $28000 \times \frac{100}{80} = \text{Rs. } 35000$

Amount spent in a month of July = $35000 \times \frac{100}{140} = \text{Rs. } 25000$

Amount spent in a month of June = $25000 \times \frac{4}{5} = \text{Rs. } 20000$

Required difference = $\frac{(35000+25000)}{2} - \frac{(28000+20000)}{2} = 30000 - 24000 = \text{Rs. } 6000$

S114. Ans.(b)

Sol.

A complete work in = $\frac{2 \times 8}{3} = \frac{16}{3}$ days

B complete work in = $4 \times 3 = 12$ days

C complete work in = $6 \times \frac{5}{3} = 10$ days

Let total work L.C.M. $\left(\frac{16}{3}, 12, 10\right) = 240$ units

So, efficiency of A = $\frac{240 \times 3}{16} = 45$ unit/day

Efficiency of B = $\frac{240}{12} = 20$ unit/day

Efficiency of C = $\frac{240}{10} = 24$ unit/day

No. of units of work done by A, B and C together in 1.5 days

= $1.5 \times (45 + 20 + 24) = 133.5$ units

Total units of work done by B alone in $\frac{69}{40}$ days = $20 \times \frac{69}{40} = 34.5$ units

So, Y = $\frac{240 - (133.5 + 34.5)}{24} = \frac{72}{24} = 3$

S115. Ans.(a)

Sol.

Let the amount invested by C be $5x$

And amount invested by B = $5x \times \frac{3}{5} = 3x$

amount invested by A = $3x \times \frac{1}{2} = 1.5x$

profit sharing ratio of A, B and C = $1.5x \times 8 + (1.5x - r) \times 4 : 3x \times 8 + (3x - r) \times 4 : 5x \times 8 + (5x - r) \times 4$
= $(18x - 4r) : (36x - 4r) : (60x - 4r)$

ATQ.

$$\frac{(18x - 4r)}{(18x - 4r) + (36x - 4r) + (60x - 4r)} = \frac{1}{10}$$

$$\frac{18x - 4r}{114x - 12r} = \frac{1}{10}$$

$$180x - 40r = 114x - 12r$$

$$66x = 28r$$

$$\frac{x}{r} = \frac{14}{33}$$

$$\text{Required ratio} = \frac{(36x - 4r)}{(60x - 4r)}$$

$$= \frac{(36 \times 14 - 4 \times 33)}{(60 \times 14 - 4 \times 33)} = \frac{372}{708} = 31:59$$

S116. Ans.(a)

Sol.

Total ET published by publisher in May & June together = $7500 \times \frac{60}{100} + 9000 \times \frac{55}{100}$
= $4500 + 4950 = 9450$

Total TOI published by publisher in March = $6000 \times \frac{60}{100} = 3600$

Required percentage = $\frac{9450 - 3600}{3600} \times 100 = 162.5\%$

S117. Ans.(d)

Sol. Total number of TOI published by publisher in March, May & June

$$= 6000 \times \frac{60}{100} + 7500 \times \frac{40}{100} + 9000 \times \frac{45}{100}$$

$$= 3600 + 3000 + 4050$$

$$= 10650$$

$$\text{Required average} = \frac{10650}{3} = 3550$$

S118. Ans.(c)

Sol.

Total TOI published by publisher in August = $8000 \times \frac{1}{2} = 4000$

Total ET published by publisher in August = $4000 \times \frac{3}{5} = 2400$

Total TOI published in May = $7500 \times \frac{40}{100} = 3000$

Required difference = $3000 - 2400 = 600$

S119. Ans.(e)

Sol.

Cost of one TOI published by publisher in June = $35 \times \frac{4}{5} = 28$ Rs.

Total cost price of all the TOI which is sold by publisher in June = $9000 \times \frac{45}{100} \times 28 = 1,13,400$ Rs.

S120. Ans.(d)

Sol. Total TOI published by publisher in April and July together

$$= 8000 \times \frac{25}{100} + 5000 \times \frac{35}{100}$$
$$= 2000 + 1750 = 3750$$

Total ET published by publisher in June = $9000 \times \frac{55}{100} = 4950$

$$\text{Required ratio} = \frac{3750}{4950} = 25 : 33$$

S121. Ans.(e)

Sol. Let total cost of three articles for shop R = x

Then total cost of three articles for shop Q = 2x.

Let total revenue of shop Q = 100y

And total revenue of shop R = 100z

As given condition.

$$\frac{100y - 2x}{2x} = \frac{100z - x}{x}$$
$$100y - 2x = 200z - 2x$$

$$\frac{y}{z} = \frac{2}{1}$$

$$\text{Required ratio} = \frac{50y}{50z}$$

$$= y : z$$

$$= 2 : 1$$

S122. Ans.(a)

Sol. Let revenue obtained by shop P, Q and R be 100x, 100y and 100z respectively.

$$\text{So, } 30x = \frac{120}{100} \times 30y = \frac{80}{100} \times 40z$$

$$15x : 18y : 16z$$

$$x : y : z = 48 : 40 : 45.$$

$$\text{Required percent} = \frac{100y}{100z} \times 100$$

$$= \frac{40}{45} \times 100 = 88\frac{8}{9}\%$$

S123. Ans.(e)

Sol. Let revenue earned by selling pencil sold by shop P = 40x

And revenue earned by selling eraser sold by shop R = 50z

$$\text{ATQ, } \frac{40x}{m} = \frac{50z}{1.2m}$$

$$\frac{x}{z} = \frac{5}{4.8} = 25 : 24$$

$$\text{Required percentage} = \frac{100x}{100z} \times 100$$

$$= \frac{25}{24} \times 100$$

$$= \frac{625}{6}\%$$

$$= 104\frac{1}{6}\%$$

S124. Ans.(d)**Sol.** Wrong term = 232

Pattern of series –

$210 + 20 = 230$

$230 + 40 = 270$

$270 + 80 = 350$

$350 + 160 = 510$

$510 + 320 = 830$

$830 + 640 = 1470$

Value of question (?) mark in series (II)

$232 + 20 = 252$

$252 + 40 = 292$

$292 + 80 = 372$

$372 + 160 = 532$

$532 + 320 = 852$

$852 + 640 = \mathbf{1492}$

S125. Ans.(a)**Sol.** Wrong term = 1040

Pattern of series –

$48 \times 3 = 144$

$144 \times 2.5 = 360$

$360 \times 2 = 720$

$720 \times 1.5 = 1080$

$1080 \times 1 = 1080$

$1080 \times 0.5 = 540$

Value of question (?) mark in series (II) -

$1040 \times 3 = 3120$

$3120 \times 2.5 = 7800$

S126. Ans.(a)**Sol.** Bollywood + Hollywood movies released in 2015 = $80 \times 2 = 160$

And, Bollywood movies released in 2015 – Hollywood movies released in 2015 = 60

So, Bollywood Movies released in 2015 = $\frac{160+60}{2} = 110$ And Hollywood movies released in 2015 = $110 - 60 = 50$

Similarly,

Year	Bollywood Movies	Hollywood Movies	Total
2015	110	50	160
2016	150	70	220
2017	140	120	260
2018	100	60	160
2019	180	120	300
Total	680	420	1100

$$\text{Required percentage} = \frac{180-120}{180} \times 100$$

$$= \frac{60}{180} \times 100 = 33\frac{1}{3}\%$$

A

BANK MAHAPACK PLUS

For IBPS, SBI, SIDBI, RBI
Grade B, +5 More

Selection Ka Saathi

S127. Ans.(b)

Sol. Bollywood + Hollywood movies released in 2015 = $80 \times 2 = 160$

And, Bollywood movies released in 2015 - Hollywood movies released in 2015 = 60

So, Bollywood Movies released in 2015 = $\frac{160+60}{2} = 110$

And Hollywood movies released in 2015 = $110 - 60 = 50$

Similarly,

Year	Bollywood Movies	Hollywood Movies	Total
2015	110	50	160
2016	150	70	220
2017	140	120	260
2018	100	60	160
2019	180	120	300
Total	680	420	1100

Required difference = $(110+50+150+70)-(150+140)$

= $380-290=90$

S128. Ans.(b)

Sol. Bollywood + Hollywood movies released in 2015 = $80 \times 2 = 160$

And, Bollywood movies released in 2015 - Hollywood movies released in 2015 = 60

So, Bollywood Movies released in 2015 = $\frac{160+60}{2} = 110$

And Hollywood movies released in 2015 = $110 - 60 = 50$

Similarly,

Year	Bollywood Movies	Hollywood Movies	Total
2015	110	50	160
2016	150	70	220
2017	140	120	260
2018	100	60	160
2019	180	120	300
Total	680	420	1100

Required ratio = $\frac{1}{5} \times (110 + 150 + 140 + 100 + 180) : \frac{1}{5} \times (50 + 70 + 120 + 60 + 120)$

= $\frac{680}{5} : \frac{420}{5}$

= 34:21

S129. Ans.(b)

Sol. Bollywood + Hollywood movies released in 2015 = $80 \times 2 = 160$

And, Bollywood movies released in 2015 - Hollywood movies released in 2015 = 60

So, Bollywood Movies released in 2015 = $\frac{160+60}{2} = 110$

And Hollywood movies released in 2015 = $110 - 60 = 50$

Similarly,

Year	Bollywood Movies	Hollywood Movies	Total
2015	110	50	160
2016	150	70	220
2017	140	120	260
2018	100	60	160
2019	180	120	300
Total	680	420	1100

Total movies (Bollywood +Hollywood) released in 2020

$$= \frac{60}{100} \times (180 + 120) = 180$$

Let Hollywood movies released in 2020 are $7x$.

$$\text{Bollywood released in 2020} = \frac{8}{7} \times 7x = 8x$$

ATQ

$$= 7x + 8x = 180$$

$$= x = 12$$

So, Hollywood movies released in 2020 = $12 \times 7 = 84$

S130. Ans.(d)

Sol. Bollywood + Hollywood movies released in 2015 = $80 \times 2 = 160$

And, Bollywood movies released in 2015 - Hollywood movies released in 2015 = 60

$$\text{So, Bollywood Movies released in 2015} = \frac{160+60}{2} = 110$$

$$\text{And Hollywood movies released in 2015} = 110 - 60 = 50$$

Similarly,

Year	Bollywood Movies	Hollywood Movies	Total
2015	110	50	160
2016	150	70	220
2017	140	120	260
2018	100	60	160
2019	180	120	300
Total	680	420	1100

$$\text{Tollywood movies released in 2018} = 215 - (100 + 60) = 55$$

$$\text{Tollywood movies released in 2019} = 55 \times \frac{14}{11} = 70$$

$$\text{So, required no.} = 180 + 120 + 70 = 370$$

S131. Ans.(b)

Sol. Let the speed of boat P in still water and speed of the current be x km/h and y km/h respectively.

$$\text{Downstream speed of boat P} = (x + y) \text{ km/h}$$

$$\text{Upstream speed of boat P} = (x - y) \text{ km/h}$$

ATQ.

$$\frac{260}{x + y} = \frac{220}{x - y}$$

$$\frac{x}{y} = \frac{12}{1}$$

Given, Ratio of the speed of boat Q in still water and speed of current is same as that for boat P

So, let the speed of boat Q in still water and speed of the current be $12u$ km/h and $1u$ km/h respectively.

downstream speed of boat Q = 39 km/h

$$12u + 1u = 39$$

$$u = 3$$

Upstream speed of boat Q = $(12 \times 3 - 1 \times 3) = 33$ km/h

Required time = $462/33 = 14$ hours

S132. Ans.(d)

Sol.

Let the marked price of article be Rs. $100x$

So, the selling price of article = $100x \times \frac{80}{100} = 80x$ Rs.

Cost price of article = $\frac{80x}{125} \times 100 = Rs\ 64x$

Discount = $100x - 80x = 20x$

Marked price - cost price = $100x - 64x = 36x$

ATQ.

$$36x - 20x = 128$$

$$x = 8$$

Cost price of article = $64 \times 8 = Rs. 512$

Required price = $512 \times \frac{17}{16} = Rs. 544$

S133. Ans.(d)

Sol.

Let the quantity of liquid A be $8x$ in mixture

So, quantity of liquid B = $8x \times \frac{137.5}{100} = 11x$

In 57 Liters

Quantity of A = $8x \times \frac{57}{19x} = 24$ liters

Quantity of B = $11x \times \frac{57}{19x} = 33$ liters

ATQ. $\frac{8x-24}{19x} = \frac{40}{100}$

$$x = 60$$

Quantity of liquid B in the final mixture

$$11 \times 60 - 33 = 627 \text{ liters}$$

S134. Ans.(e)

Sol. Total number of female employees working in both company = $420 \times 2 = 840$

Let total male employee in HCL = x

and total male employee in IBM = y

$$x + y = 1620 \dots(i)$$

$$\text{and } \frac{2}{3}x + \frac{2}{5}y = 840 \dots(ii)$$

from (i) and (ii) —

$$x = 720$$

$$y = 900$$

female employee in HCL = $720 \times \frac{2}{3} = 480$

Female employee in IBM = $900 \times \frac{2}{5} = 360$

Required percentage = $\frac{480 \times \frac{7}{12}}{(720+480)} \times 100 = 23\frac{1}{3}\%$

S135. Ans.(d)

Sol. Total number of female employees working in both company = $420 \times 2 = 840$

Let total male employee in HCL = x

and total male employee in IBM = y

$$x + y = 1620 \dots(i)$$

$$\text{and } \frac{2}{3}x + \frac{2}{5}y = 840 \dots(ii)$$

from (i) and (ii) —

$$x = 720$$

$$y = 900$$

$$\text{female employee in HCL} = 720 \times \frac{2}{3} = 480$$

$$\text{Female employee in IBM} = 900 \times \frac{2}{5} = 360$$

$$\text{Required ratio} = \frac{360}{720} = 1 : 2$$

S136. Ans.(e)

Sol.

Quantity I Let efficiency of A = x

$$\text{So, efficiency of B} = x \times \frac{300}{100} = 3x$$

$$\text{Total work} = (x + 3x) \times 12 = 48x$$

$$\text{Required time} = \frac{48x}{x} = 48 \text{ days.}$$

Quantity II. Two men can do the $\frac{1}{2}$ work in 96 days.

So, two men can do the work in 192 days.

$$\text{So, 8 men can do the work in } 2 \times \frac{192}{8} = 48 \text{ days}$$

Quantity I = Quantity II

S137. Ans.(a)

Sol. Quantity I. Let speed of boat u kmph and speed of stream v kmph.

ATQ,

$$u+v = u-v+5$$

$$v = 2.5 \text{ kmph}$$

and speed of boat = 12.5 kmph

$$\frac{X}{15} : \frac{X-5}{10} = 3 : 4$$

$$X = 45 \text{ km}$$

Quantity II: 40

Quantity I > Quantity II

S138. Ans.(c)

Sol. Let the ten's place and unit's place digits of the number be x and y respectively.

And, the number = $(10x + y)$

$$\text{From I: } x+y=0.25(10x+y)$$

$$\Rightarrow y = 2x$$

$$\text{From II: } 3(10x + y) - (10y + x) = 30$$

$$\Rightarrow 29x - 7y = 30$$

Hence, both the statements together are sufficient to answer the question.

S139. Ans.(d)

Sol. Let the marked price and cost price be Rs 80x and Rs 50x respectively

$$\text{From I: Selling price} = 80x \times \frac{4}{5} \times \frac{9}{10} = \text{Rs } 57.6x$$

$$\text{And } 16x - 6.4x = 192$$

$$x = 20$$

$$\text{Selling price} = \text{Rs } 1152$$

From II: Marked price - Cost price = Rs 600

$$80x - 50x = 600$$

$$\text{Marked price} = \text{Rs } 1600$$

$$\text{And cost price} = \text{Rs } 1000$$

$$\text{Selling price} = \text{Rs } 1152$$

Hence, either of the two statements is sufficient to answer the question.

S140. Ans.(c)

Sol.

$$\frac{4^{3(2a)}}{4^b 4^{2(2b)}} = ?$$

$$\frac{4^{6a}}{4^{4b} 4^b} = ?$$

$$4^{(6a-5b)} = ?$$

$$\text{From I. } 4^8$$

$$\text{From II. } a = 3$$

$$b = 14 - 4 \times 3 = 2$$

$$(6a - 5b) = (6 \times 3 - 5 \times 2) = 8$$

$$4^8$$

So, either statement (I) or statement (II) by itself is sufficient to answer the question.

S141. Ans.(d)

Sol. Final arrangement:

Designations	Persons
Chairman	T
MD	W
CEO	X
COO	Q
CFO	U
CAO	R
CIO	V
CTO	S
CMO	Y
CHRO	Z

Clues:

R works three positions senior to the one who is immediately junior to S. More than four persons are senior to R.

Inference:

From above conditions we get two possibilities.

Designations	Persons	Persons
	Case 1	Case 2
Chairman		
MD		
CEO		
COO		
CFO		
CAO		R
CIO	R	
CTO		S
CMO	S	
CHRO		

Cues:

Only three persons are designated between R and W. The number of persons senior to W is the same as the number of persons junior to Y. Q is immediately junior to the one who works four positions senior to V. Q neither works as Chairman nor CIO.

Inference:

From above conditions we get two more possibilities from case 2.

Designations	Persons	Persons	Persons	Persons
	Case 1	Case 2	Case 2a	Case 2b
Chairman			Y	Y
MD	Q	W	Q	
CEO	W			
COO		Q		Q
CFO	V		V	
CAO		R	R	R
CIO	R	V		V
CTO	Y	S	S	S
CMO	S	Y		
CHRO			W	W

Clues:

The number of persons designated between Q and R is the same as the number of persons designated between S and Z. X is senior to U but not senior to T. U is designated as neither CMO nor CHRO.

Inference:

From above conditions case 1 case 2a and case 2b get cancelled here.

Designations	Persons	Persons	Persons	Persons
	Case 1	Case 2	Case 2a	Case 2b
Chairman	T	T	W	W
MD	Q	W	Q	
CEO	W	X	T	
COO	Z	Q	Z	Q
CFO	V	U	V	
CAO	X	R	R	R
CIO	R	V	X	V
CTO	Y	S	S	S
CMO	S	Y	U	
CHRO	U	Z	W	W

Inference:

After combining all the information we get final arrangement.

Designations	Persons
Chairman	T
MD	W
CEO	X
COO	Q
CFO	U
CAO	R
CIO	V
CTO	S
CMO	Y
CHRO	Z

Only I and II are true with respect to the final arrangement.

S142. Ans.(a)

Sol. Final arrangement:

Designations	Persons
Chairman	T
MD	W
CEO	X
COO	Q
CFO	U
CAO	R
CIO	V
CTO	S
CMO	Y
CHRO	Z

Clues:

R works three positions senior to the one who is immediately junior to S. More than four persons are senior to R.

Inference:

From above conditions we get two possibilities.

Designations	Persons	Persons
	Case 1	Case 2
Chairman		
MD		
CEO		
COO		
CFO		
CAO		R
CIO	R	
CTO		S
CMO	S	
CHRO		

Cues:

Only three persons are designated between R and W. The number of persons senior to W is the same as the number of persons junior to Y. Q is immediately junior to the one who works four positions senior to V. Q neither works as Chairman nor CIO.

Inference:

From above conditions we get two more possibilities from case 2.

Designations	Persons	Persons	Persons	Persons
	Case 1	Case 2	Case 2a	Case 2b
Chairman			Y	Y
MD	Q	W	Q	
CEO	W			
COO		Q		Q
CFO	V		V	
CAO		R	R	R
CIO	R	V		V
CTO	Y	S	S	S
CMO	S	Y		
CHRO			W	W

Clues:

The number of persons designated between Q and R is the same as the number of persons designated between S and Z. X is senior to U but not senior to T. U is designated as neither CMO nor CHRO.

Inference:

From above conditions case 1 case 2a and case 2b get cancelled here.

Designations	Persons	Persons	Persons	Persons
	Case 1	Case 2	Case 2a	Case 2b
Chairman	T	T	W	W
MD	Q	W	Q	
CEO	W	X	T	
COO	Z	Q	Z	Q
CFO	V	U	V	
CAO	X	R	R	R
CIO	R	V	X	V
CTO	Y	S	S	S
CMO	S	Y	U	
CHRO	U	Z	W	W

Inference:

After combining all the information we get final arrangement.

Designations	Persons
Chairman	T
MD	W
CEO	X
COO	Q
CFO	U
CAO	R
CIO	V
CTO	S
CMO	Y
CHRO	Z

Q works as COO.

S143. Ans.(e)

Sol. Final arrangement:

Designations	Persons
Chairman	T
MD	W
CEO	X
COO	Q
CFO	U
CAO	R
CIO	V
CTO	S
CMO	Y
CHRO	Z

Clues:

R works three positions senior to the one who is immediately junior to S. More than four persons are senior to R.

Inference:

From above conditions we get two possibilities.

Designations	Persons	Persons
	Case 1	Case 2
Chairman		
MD		
CEO		
COO		
CFO		
CAO		R
CIO	R	
CTO		S
CMO	S	
CHRO		

Cues:

Only three persons are designated between R and W. The number of persons senior to W is the same as the number of persons junior to Y. Q is immediately junior to the one who works four positions senior to V. Q neither works as Chairman nor CIO.

Inference:

From above conditions we get two more possibilities from case 2.

Designations	Persons	Persons	Persons	Persons
	Case 1	Case 2	Case 2a	Case 2b
Chairman			Y	Y
MD	Q	W	Q	
CEO	W			
COO		Q		Q
CFO	V		V	
CAO		R	R	R
CIO	R	V		V
CTO	Y	S	S	S
CMO	S	Y		
CHRO			W	W

Clues:

The number of persons designated between Q and R is the same as the number of persons designated between S and Z. X is senior to U but not senior to T. U is designated as neither CMO nor CHRO.

Inference:

From above conditions case 1 case 2a and case 2b get cancelled here.

Designations	Persons	Persons	Persons	Persons
	Case-1	Case 2	Case-2a	Case-2b
Chairman	T	T	W	W
MD	Q	W	Q	
CEO	W	X	T	
COO	Z	Q	Z	Q
CFO	V	U	V	
CAO	X	R	R	R
CIO	R	V	X	V
CTO	Y	S	S	S
CMO	S	Y	U	
CHRO	U	Z	W	W

Inference:

After combining all the information we get final arrangement.

Designations	Persons
Chairman	T
MD	W
CEO	X
COO	Q
CFO	U
CAO	R
CIO	V
CTO	S
CMO	Y
CHRO	Z

Except YT, there is one designation gap between the given persons.

S144. Ans.(d)

Sol. Final arrangement:

Designations	Persons
Chairman	T
MD	W
CEO	X
COO	Q
CFO	U
CAO	R
CIO	V
CTO	S
CMO	Y
CHRO	Z

Clues:

R works three positions senior to the one who is immediately junior to S. More than four persons are senior to R.

Inference:

From above conditions we get two possibilities.

Designations	Persons	Persons
	Case 1	Case 2
Chairman		
MD		
CEO		
COO		
CFO		
CAO		R
CIO	R	
CTO		S
CMO	S	
CHRO		

Cues:

Only three persons are designated between R and W. The number of persons senior to W is the same as the number of persons junior to Y. Q is immediately junior to the one who works four positions senior to V. Q neither works as Chairman nor CIO.

Inference:

From above conditions we get two more possibilities from case 2.

Designations	Persons	Persons	Persons	Persons
	Case 1	Case 2	Case 2a	Case 2b
Chairman			Y	Y
MD	Q	W	Q	
CEO	W			
COO		Q		Q
CFO	V		V	
CAO		R	R	R
CIO	R	V		V
CTO	Y	S	S	S
CMO	S	Y		
CHRO			W	W

Clues:

The number of persons designated between Q and R is the same as the number of persons designated between S and Z. X is senior to U but not senior to T. U is designated as neither CMO nor CHRO.

Inference:

From above conditions case 1 case 2a and case 2b get cancelled here.

Designations	Persons	Persons	Persons	Persons
	Case-1	Case 2	Case-2a	Case-2b
Chairman	T	T	W	W
MD	Q	W	Q	
CEO	W	X	T	
COO	Z	Q	Z	Q
CFO	V	U	V	
CAO	X	R	R	R
CIO	R	V	X	V
CTO	Y	S	S	S
CMO	S	Y	U	
CHRO	U	Z	W	W

Inference:

After combining all the information we get final arrangement.

Designations	Persons
Chairman	T
MD	W
CEO	X
COO	Q
CFO	U
CAO	R
CIO	V
CTO	S
CMO	Y
CHRO	Z

Four persons are senior to U.

S145. Ans.(c)

Sol. Final arrangement:

Designations	Persons
Chairman	T
MD	W
CEO	X
COO	Q
CFO	U
CAO	R
CIO	V
CTO	S
CMO	Y
CHRO	Z

Clues:

R works three positions senior to the one who is immediately junior to S. More than four persons are senior to R.

Inference:

From above conditions we get two possibilities.

Designations	Persons	Persons
	Case 1	Case 2
Chairman		
MD		
CEO		
COO		
CFO		
CAO		R
CIO	R	
CTO		S
CMO	S	
CHRO		

Cues:

Only three persons are designated between R and W. The number of persons senior to W is the same as the number of persons junior to Y. Q is immediately junior to the one who works four positions senior to V. Q neither works as Chairman nor CIO.

Inference:

From above conditions we get two more possibilities from case 2.

Designations	Persons	Persons	Persons	Persons
	Case 1	Case 2	Case 2a	Case 2b
Chairman			Y	Y
MD	Q	W	Q	
CEO	W			
COO		Q		Q
CFO	V		V	
CAO		R	R	R
CIO	R	V		V
CTO	Y	S	S	S
CMO	S	Y		
CHRO			W	W

Clues:

The number of persons designated between Q and R is the same as the number of persons designated between S and Z. X is senior to U but not senior to T. U is designated as neither CMO nor CHRO.

Inference:

From above conditions case 1 case 2a and case 2b get cancelled here.

Designations	Persons	Persons	Persons	Persons
	Case 1	Case 2	Case 2a	Case 2b
Chairman	T	T	W	W
MD	Q	W	Q	
CEO	W	X	T	
COO	Z	Q	Z	Q
CFO	V	U	V	
CAO	X	R	R	R
CIO	R	V	X	V
CTO	V	S	S	S
CMO	S	Y	U	
CHRO	U	Z	W	W

Inference:

After combining all the information we get final arrangement.

Designations	Persons
Chairman	T
MD	W
CEO	X
COO	Q
CFO	U
CAO	R
CIO	V
CTO	S
CMO	Y
CHRO	Z

S's designation is CTO.

S146. Ans.(a)

Sol.

NEWSPAPER

S147. Ans.(c)

Sol. Final arrangement:

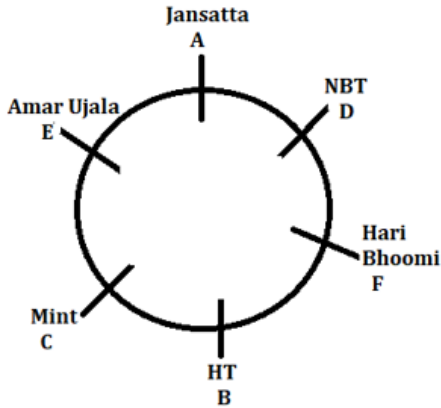

Clues:

C sits second to the left of the one who reads Hari Bhoomi. A neither sits opposite to C nor to the one who reads Hari Bhoomi. A does not read Hari Bhoomi but sits adjacent to D.

Inference:

From above conditions we get three possibilities.

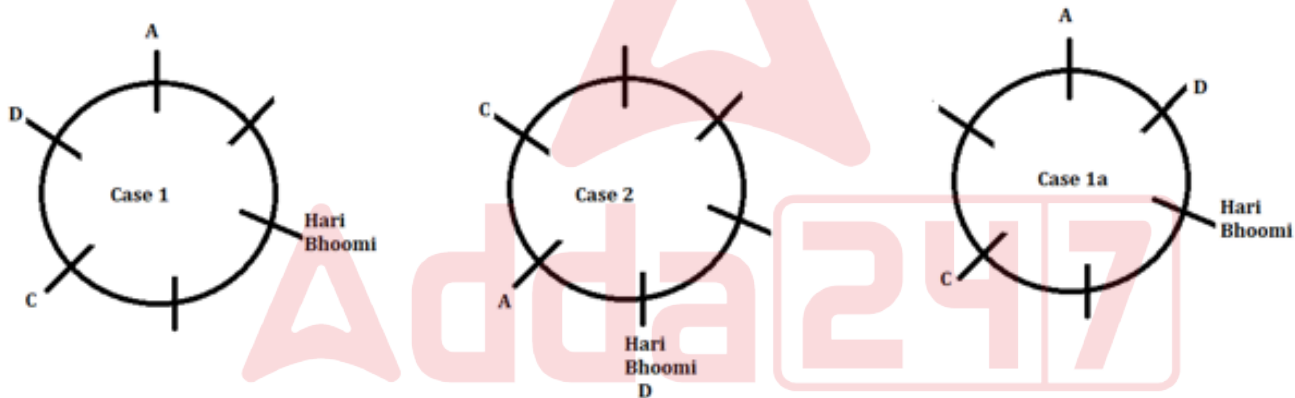

Clues:

The one who reads Amar Ujala sits second to the right of D. B sits second to the right of E. The one who reads Mint sits second to the left of F.

Inference:

From above conditions case 2 get cancelled here.

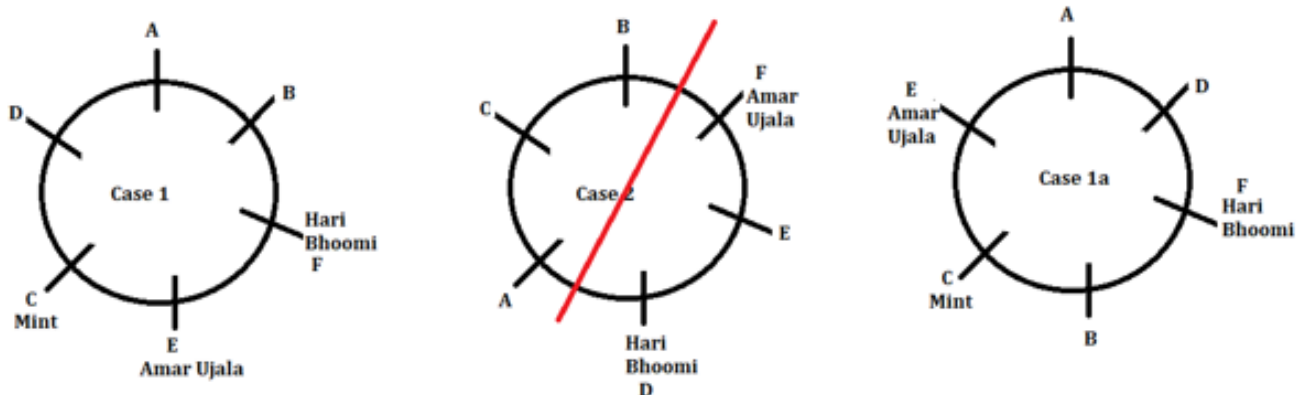

Clues:

The one who reads Jansatta sits immediate right of the one who reads NBT. B does not read NBT. The one who reads NBT does not sit opposite to the one who reads Amar Ujala.

Inference:

From above conditions case 1 get cancelled here.

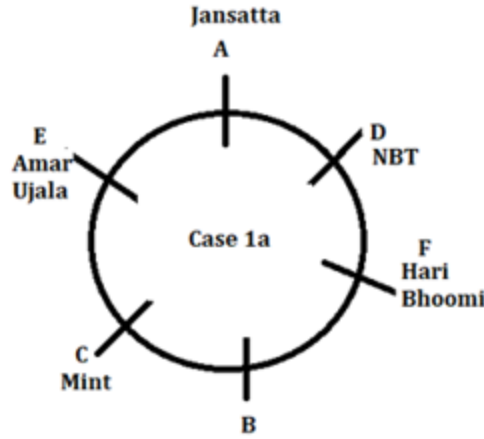
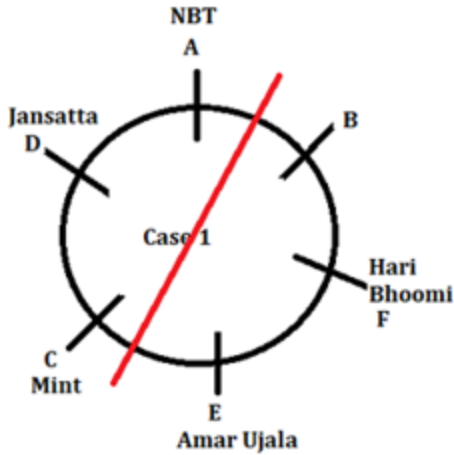

Inference:

We know, one of them reads HT and after combining all the information we get final arrangement.

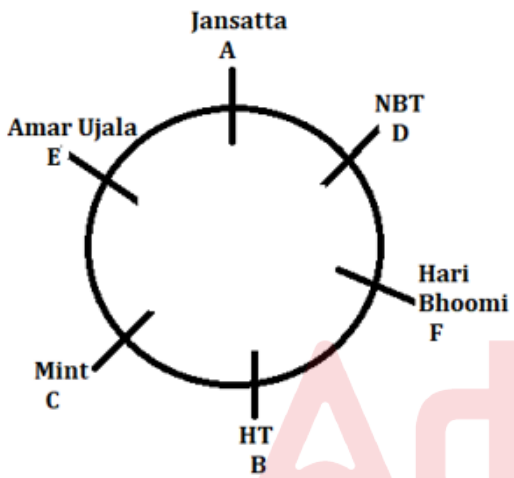

E sits opposite to the one who reads Hari Bhoomi.

S148. Ans.(d)

Sol. Final arrangement:

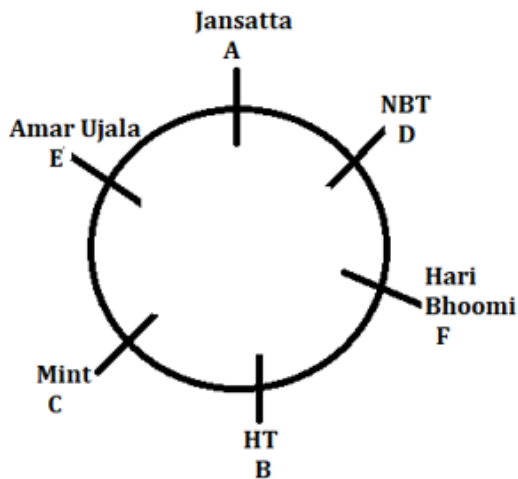

Clues:

C sits second to the left of the one who reads Hari Bhoomi. A neither sits opposite to C nor to the one who reads Hari Bhoomi. A does not read Hari Bhoomi but sits adjacent to D.

Inference:

From above conditions we get three possibilities.

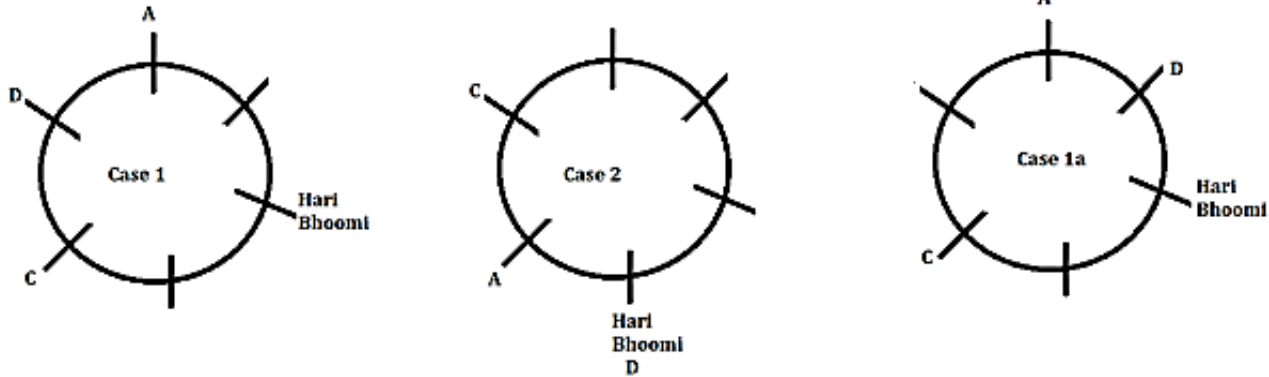

Clues:

The one who reads Amar Ujala sits second to the right of D. B sits second to the right of E. The one who reads Mint sits second to the left of F.

Inference:

From above conditions case 2 get cancelled here.

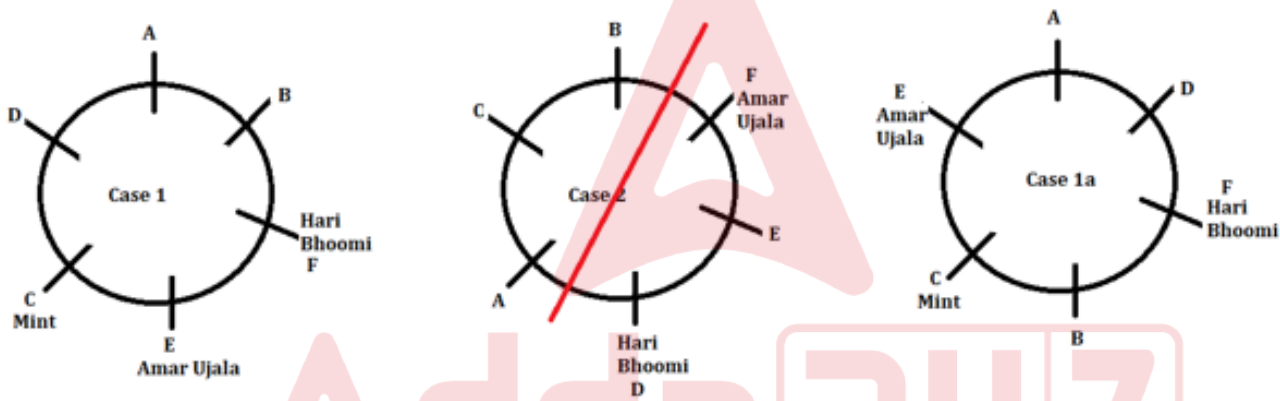

Clues:

The one who reads Jansatta sits immediate right of the one who reads NBT. B does not read NBT. The one who reads NBT does not sit opposite to the one who reads Amar Ujala.

Inference:

From above conditions case 1 get cancelled here.

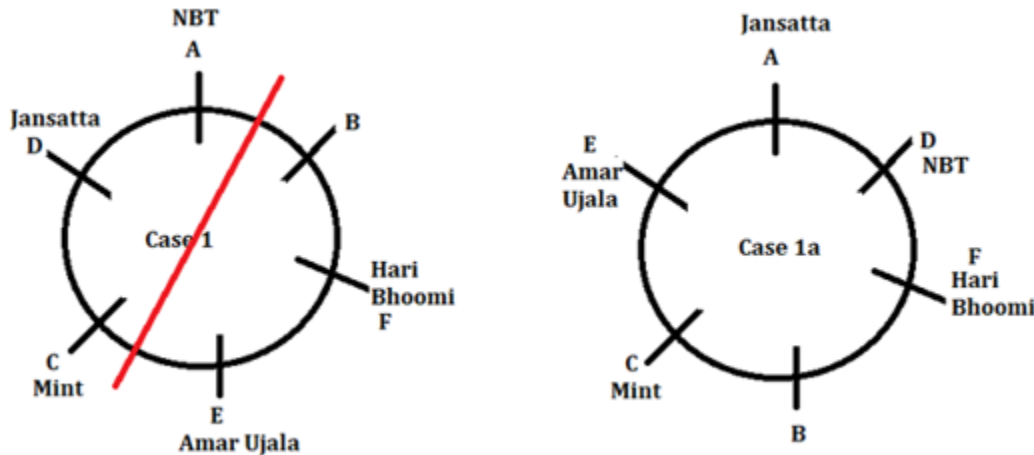

Inference:

We know, one of them reads HT and after combining all the information we get final arrangement.

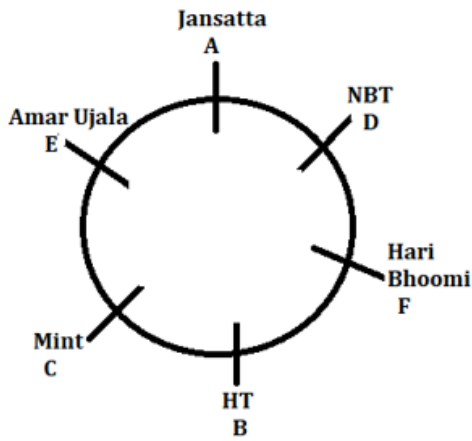

C sits third to the right of the one who reads NBT.

S149. Ans.(e)

Sol. Final arrangement:

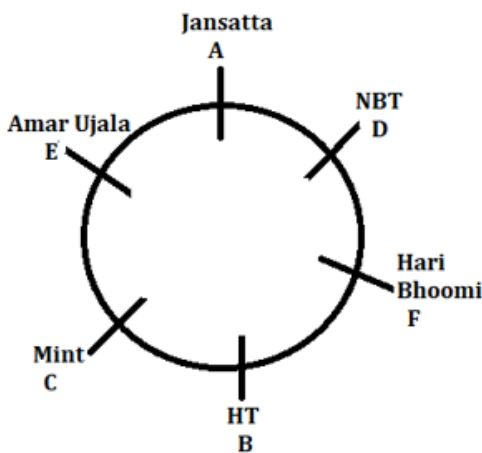

Clues:

C sits second to the left of the one who reads Hari Bhoomi. A neither sits opposite to C nor to the one who reads Hari Bhoomi. A does not read Hari Bhoomi but sits adjacent to D.

Inference:

From above conditions we get three possibilities.

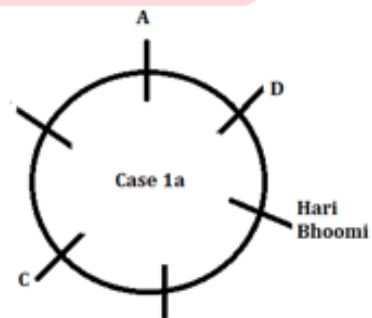
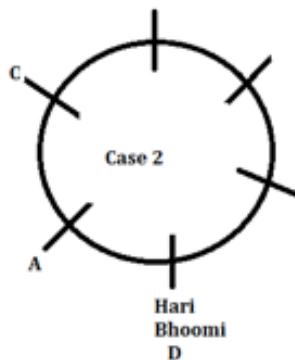
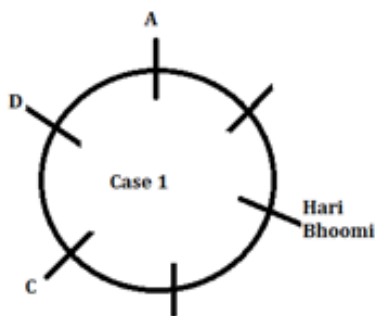

Clues:

The one who reads Amar Ujala sits second to the right of D. B sits second to the right of E. The one who reads Mint sits second to the left of F.

Inference:

From above conditions case 2 get cancelled here.

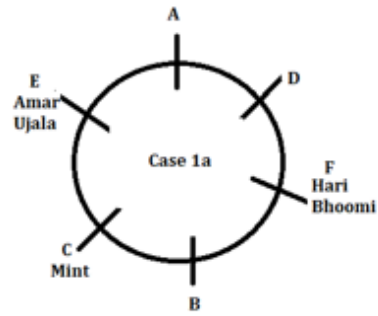
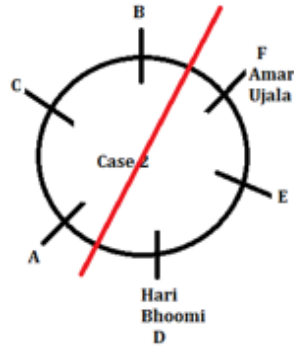
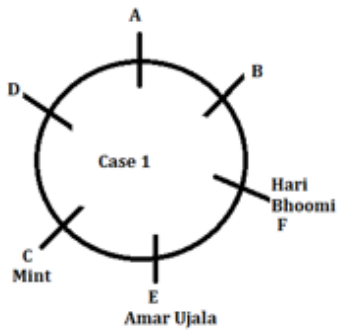

Clues:

The one who reads Jansatta sits immediate right of the one who reads NBT. B does not read NBT. The one who reads NBT does not sit opposite to the one who reads Amar Ujala.

Inference:

From above conditions case 1 get cancelled here.

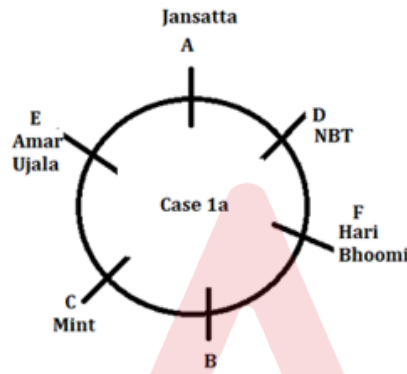
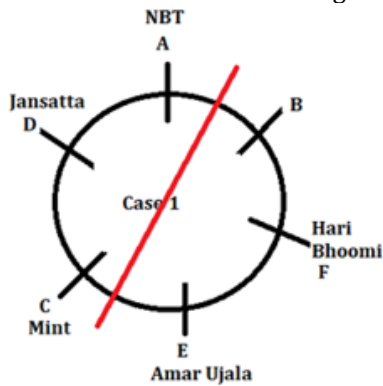

Inference:

We know, one of them reads HT and after combining all the information we get final arrangement.

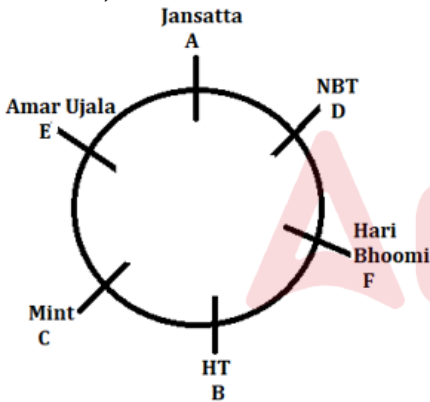

One person unchanged in their position.

S150. Ans.(c)

Sol. Final arrangement:

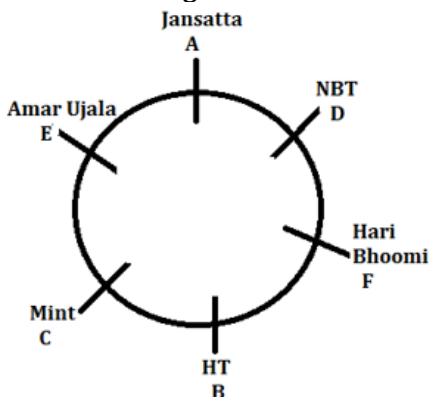

Clues:

C sits second to the left of the one who reads Hari Bhoomi. A neither sits opposite to C nor to the one who reads Hari Bhoomi. A does not read Hari Bhoomi but sits adjacent to D.

Inference:

From above conditions we get three possibilities.

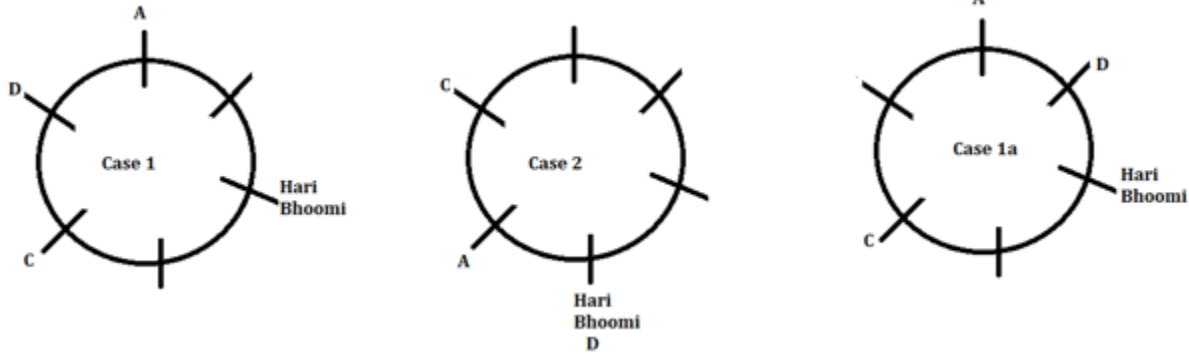

Clues:

The one who reads Amar Ujala sits second to the right of D. B sits second to the right of E. The one who reads Mint sits second to the left of F.

Inference:

From above conditions case 2 get cancelled here.

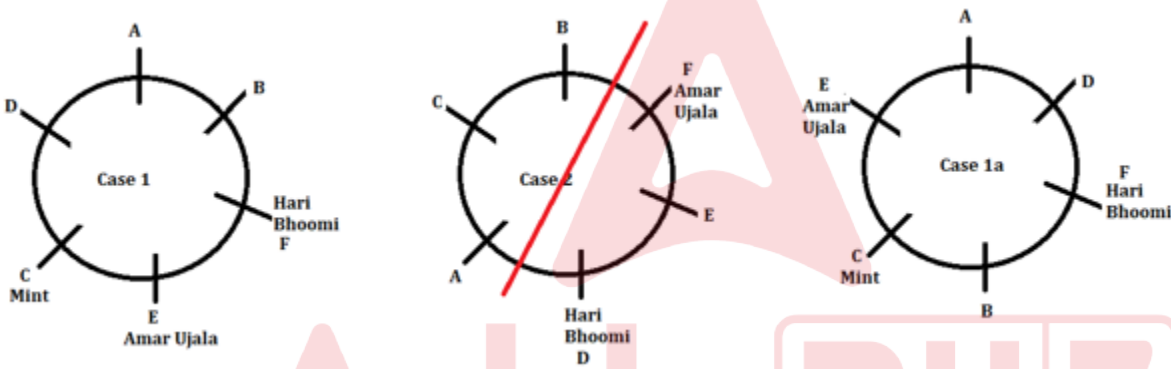

Clues:

The one who reads Jansatta sits immediate right of the one who reads NBT. B does not read NBT. The one who reads NBT does not sit opposite to the one who reads Amar Ujala.

Inference:

From above conditions case 1 get cancelled here.

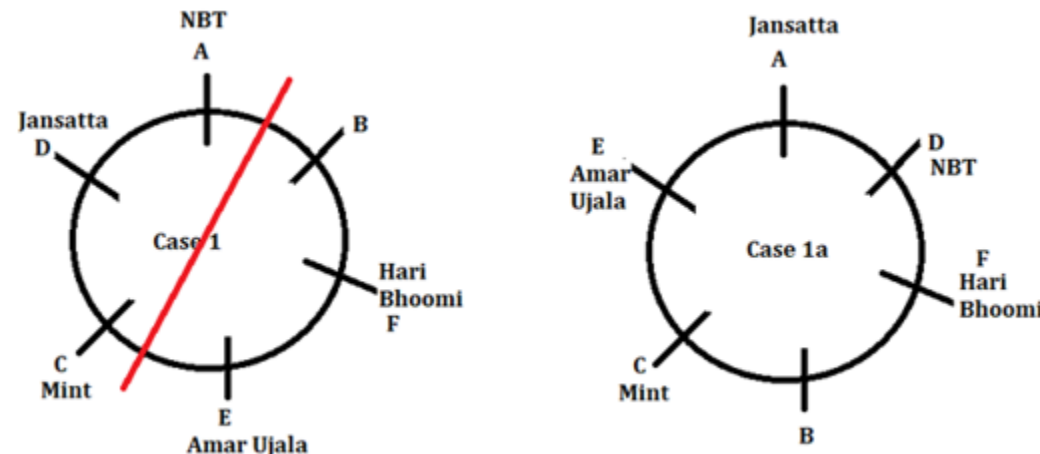

Inference:

We know, one of them reads HT and after combining all the information we get final arrangement.

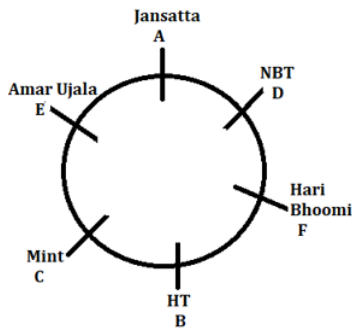

D reads NBT.

S151. Ans.(a)

Sol. Final arrangement:

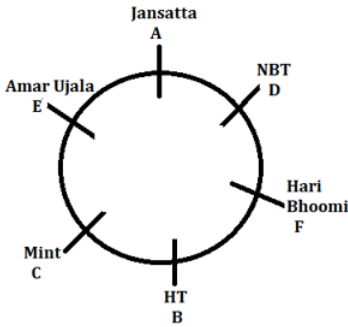

Clues:

C sits second to the left of the one who reads Hari Bhoomi. A neither sits opposite to C nor to the one who reads Hari Bhoomi. A does not read Hari Bhoomi but sits adjacent to D.

Inference:

From above conditions we get three possibilities.

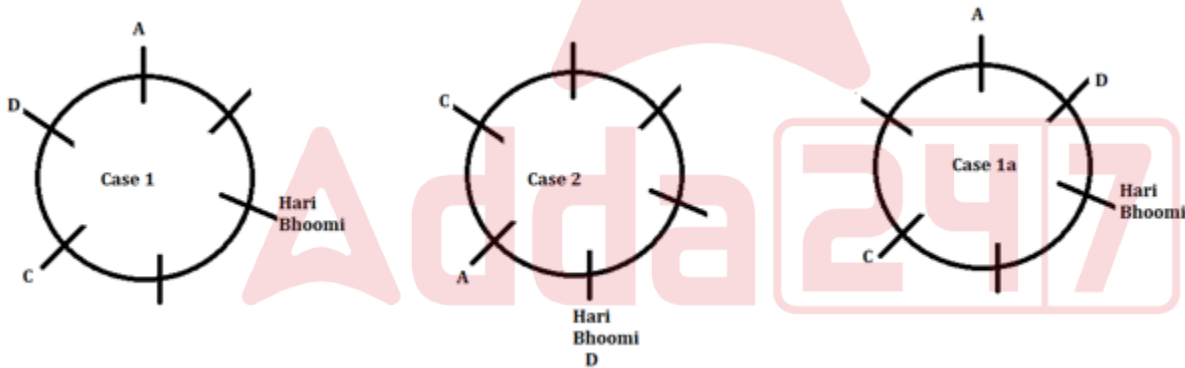

Clues:

The one who reads Amar Ujala sits second to the right of D. B sits second to the right of E. The one who reads Mint sits second to the left of F.

Inference:

From above conditions case 2 get cancelled here.

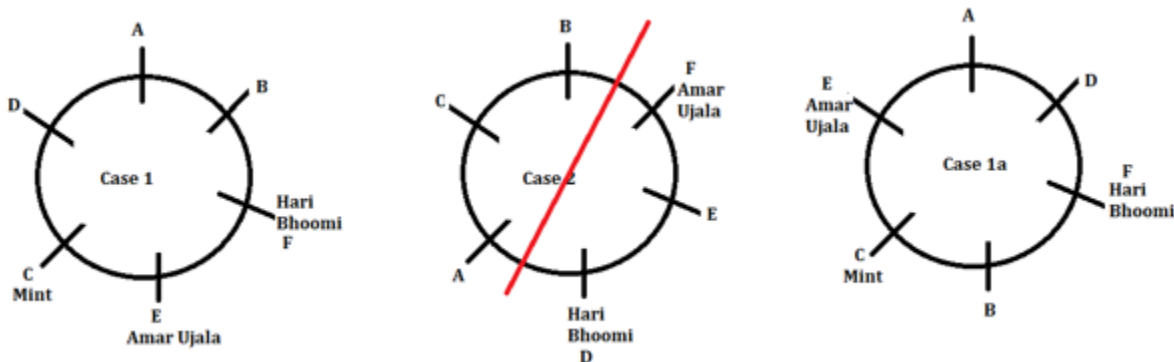

Clues:

The one who reads Jansatta sits immediate right of the one who reads NBT. B does not read NBT. The one who reads NBT does not sit opposite to the one who reads Amar Ujala.

Inference:

From above conditions case 1 get cancelled here.

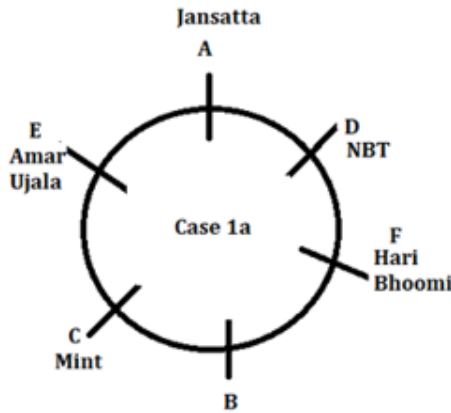
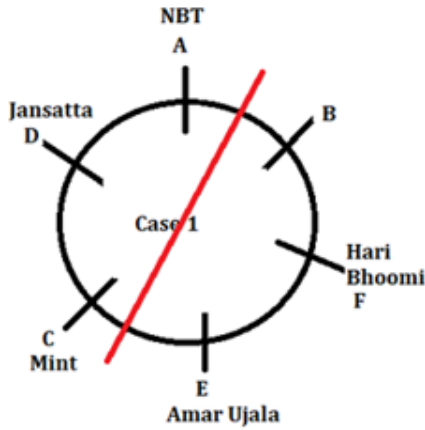

Inference:

We know, one of them reads HT and after combining all the information we get final arrangement.

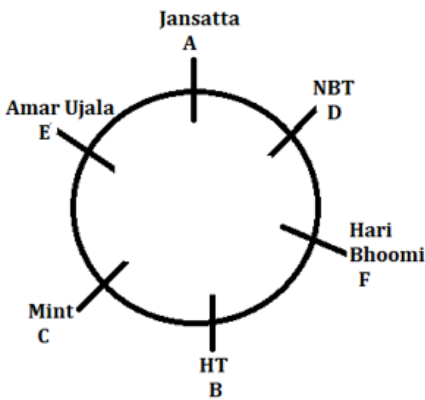

Only I and II statements are true with respect to the given arrangement.

S152. Ans.(e)

Sol.

Words	Codes
Golf	28
Cricket	82
Fencing	23
Soccer	36
Curling/Archery	91/52
Pool	15
Judo	59
Hockey/ Karate	90/76
Rugby	84
Cycling	69

Required sum- $82+23=105$.

S153. Ans.(c)

Sol.

Words	Codes
Golf	28
Cricket	82
Fencing	23
Soccer	36
Curling/Archery	91/52
Pool	15
Judo	59
Hockey/ Karate	90/76
Rugby	84
Cycling	69

A

RBI P21 BATCH 4.0

Live Foundation Batch
Target 2024



Starts: 11 Mar | 6 am - 10 pm

S154. Ans.(a)

Sol. A+B (15m) - A is 20m north of B=15+5=20

A&B (13m) - A is 11m south of B=13-2=11

A*B (25m) - A is 22m east of B=25-3=22

A!B (13m) - A is 20m west of B=13+7=20

From the above condition, we get

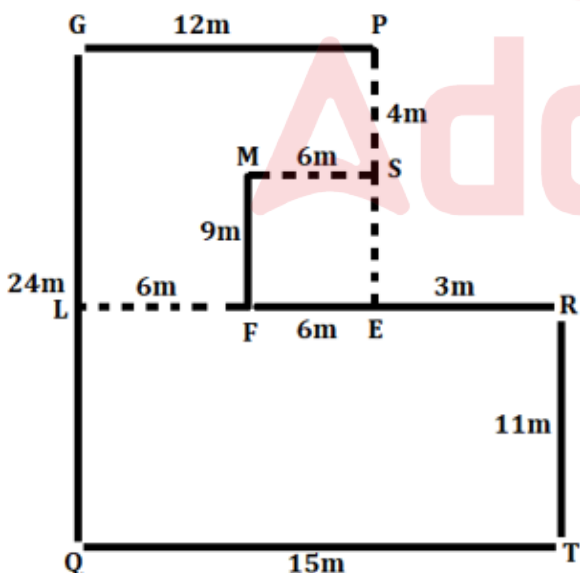

S155. Ans.(d)

Sol. A+B (15m) - A is 20m north of B=15+5=20

A&B (13m) - A is 11m south of B=13-2=11

A*B (25m) - A is 22m east of B=25-3=22

A!B (13m) - A is 20m west of B=13+7=20

From the above condition, we get

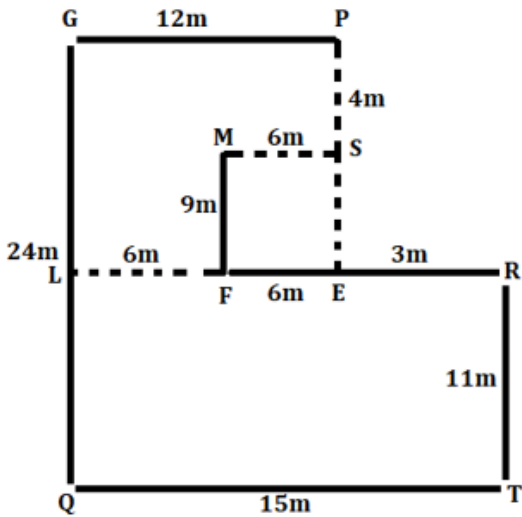

S156. Ans.(e)

Sol. A+B (15m) - A is 20m north of B=15+5=20

A&B (13m) - A is 11m south of B=13-2=11

A*B (25m) - A is 22m east of B=25-3=22

A!B (13m) - A is 20m west of B=13+7=20

From the above condition, we get

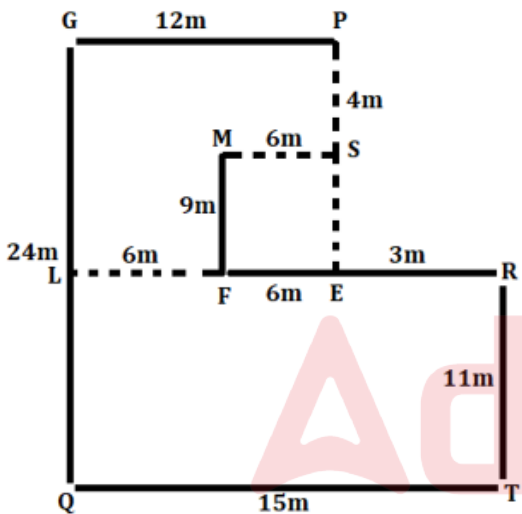

S157. Ans.(b)

Sol. Final arrangement:

Floors	Flat 1	Flat 2
6	Buffalo	Hen
5	Bull	Donkey
4	Camel	Ox
3	Cow	Sheep
2	Duck	Yak
1	Goat	Monkey

Clues:

Not more than two floors are there below Duck whereas Sheep was caged on the floor immediately above Duck but in a different flat as Duck. The number of floors above Sheep is the same as the number of floors below Ox, which was not caged in flat 1 but in the same flat as Sheep. Two floors are there between Ox and Goat where both were caged in different flats.

Inference:

From above conditions we get three possibilities.

Floors	Flat 1	Flat 2	Floors	Flat 1	Flat 2	Floors	Flat 1	Flat 2
	Case 1			Case 2			Case 3	
6	Goat		6			6		
5			5			5		Ox
4		Sheep	4		Ox	4		
3	Duck	Ox	3		Sheep	3		
2			2	Duck		2	Goat	Sheep
1			1	Goat		1	Duck	

Clues:

The number of floors between Goat and Duck is one less than the number of floors between Ox and Buffalo which was not caged on the adjacent floor of Goat. The number of floors below Buffalo is one more than the number of floors above Yak. Monkey was caged in the flat immediately below Yak.

Inference:

From above conditions we get one more possibility and case 1 and case 3 get cancelled.

Floors	Flat 1	Flat 2	Floors	Flat 1	Flat 2	Floors	Flat 1	Flat 2
	Case 1			Case 2			Case 3	
6	Goat		6	Buffalo		6		
5			5			5		Ox
4		Sheep	4		Ox	4		
3	Duck	Ox	3		Sheep	3		Buffalo
2			2	Duck	Yak	2	Goat	Sheep
1			1	Goat	Monkey	1	Duck	

Floors	Flat 1	Flat 2
	Case 2a	
6		Buffalo
5		
4		Ox
3		Sheep
2	Duck	Yak
1	Goat	Monkey

Clues:

Hen was caged in the flat which is three floors above Cow but in a different flat as Cow. Bull was caged in one of the odd numbered floors and flat. Camel was not caged on the same floor as Bull.

Inference:

From above condition case 2a get cancelled.

Floors	Flat 1	Flat 2	Floors	Flat 1	Flat 2
	Case 2			Case 2a	
6	Buffalo	Hen	6		Buffalo
5	Bull		5		
4	Camel	Ox	4		Ox
3	Cow	Sheep	3		Sheep
2	Duck	Yak	2	Duck	Yak
1	Goat	Monkey	1	Goat	Monkey

Inference:

We know Donkey is one of the animals, so the final arrangement is :-

Floors	Flat 1	Flat 2
6	Buffalo	Hen
5	Bull	Donkey
4	Camel	Ox
3	Cow	Sheep
2	Duck	Yak
1	Goat	Monkey

As many floors below Cow as above Camel.

S158. Ans.(c)

Sol. Final arrangement:

Floors	Flat 1	Flat 2
6	Buffalo	Hen
5	Bull	Donkey
4	Camel	Ox
3	Cow	Sheep
2	Duck	Yak
1	Goat	Monkey

Clues:

Not more than two floors are there below Duck whereas Sheep was caged on the floor immediately above Duck but in a different flat as Duck. The number of floors above Sheep is the same as the number of floors below Ox, which was not caged in flat 1 but in the same flat as Sheep. Two floors are there between Ox and Goat where both were caged in different flats.

Inference:

From above conditions we get three possibilities.

Floors	Flat 1	Flat 2	Floors	Flat 1	Flat 2	Floors	Flat 1	Flat 2
	Case 1			Case 2			Case 3	
6	Goat		6			6		
5			5			5		Ox
4		Sheep	4		Ox	4		
3	Duck	Ox	3		Sheep	3		
2			2	Duck		2	Goat	Sheep
1			1	Goat		1	Duck	

Clues:

The number of floors between Goat and Duck is one less than the number of floors between Ox and Buffalo which was not caged on the adjacent floor of Goat. The number of floors below Buffalo is one more than the number of floors above Yak. Monkey was caged in the flat immediately below Yak.

Inference:

From above conditions we get one more possibility and case 1 and case 3 get cancelled.

Floors	Flat 1	Flat 2	Floors	Flat 1	Flat 2	Floors	Flat 1	Flat 2
	Case 1			Case 2			Case 3	
6	Goat		6	Buffalo		6		
5			5			5		Ox
4		Sheep	4		Ox	4		
3	Duck	Ox	3		Sheep	3		Buffalo
2			2	Duck	Yak	2	Goat	Sheep
1			1	Goat	Monkey	1	Duck	

Floors	Flat 1	Flat 2
	Case 2a	
6		Buffalo
5		
4		Ox
3		Sheep
2	Duck	Yak
1	Goat	Monkey

Clues:

Hen was caged in the flat which is three floors above Cow but in a different flat as Cow. Bull was caged in one of the odd numbered floors and flat. Camel was not caged on the same floor as Bull.

Inference:

From above condition case 2a get cancelled.

Floors	Flat 1	Flat 2	Floors	Flat 1	Flat 2
Case 2			Case 2a		
6	Buffalo	Hen	6		Buffalo
5	Bull		5		
4	Camel	Ox	4		Ox
3	Cow	Sheep	3		Sheep
2	Duck	Yak	2	Duck	Yak
1	Goat	Monkey	1	Goat	Monkey

Inference:

We know Donkey is one of the animals, so the final arrangement is :-

Floors	Flat 1	Flat 2
6	Buffalo	Hen
5	Bull	Donkey
4	Camel	Ox
3	Cow	Sheep
2	Duck	Yak
1	Goat	Monkey

Ox is related to Monkey.

S159. Ans.(d)

Sol. Final arrangement:

Floors	Flat 1	Flat 2
6	Buffalo	Hen
5	Bull	Donkey
4	Camel	Ox
3	Cow	Sheep
2	Duck	Yak
1	Goat	Monkey

Clues:

Not more than two floors are there below Duck whereas Sheep was caged on the floor immediately above Duck but in a different flat as Duck. The number of floors above Sheep is the same as the number of floors below Ox, which was not caged in flat 1 but in the same flat as Sheep. Two floors are there between Ox and Goat where both were caged in different flats.

Inference:

From above conditions we get three possibilities.

Floors	Flat 1	Flat 2	Floors	Flat 1	Flat 2	Floors	Flat 1	Flat 2
Case 1			Case 2			Case 3		
6	Goat		6			6		
5			5			5		Ox
4		Sheep	4		Ox	4		
3	Duck	Ox	3		Sheep	3		
2			2	Duck		2	Goat	Sheep
1			1	Goat		1	Duck	

Clues:

The number of floors between Goat and Duck is one less than the number of floors between Ox and Buffalo which was not caged on the adjacent floor of Goat. The number of floors below Buffalo is one more than the number of floors above Yak. Monkey was caged in the flat immediately below Yak.

Inference:

From above conditions we get one more possibility and case 1 and case 3 get cancelled.

Floors	Flat 1	Flat 2	Floors	Flat 1	Flat 2	Floors	Flat 1	Flat 2
	Case 1			Case 2			Case 3	
6	Goat		6	Buffalo		6		
5			5			5		Ox
4		Sheep	4		Ox	4		
3	Duck	Ox	3		Sheep	3		Buffalo
2			2	Duck	Yak	2	Goat	Sheep
1			1	Goat	Monkey	1	Duck	

Floors	Flat 1	Flat 2
	Case 2a	
6		Buffalo
5		
4		Ox
3		Sheep
2	Duck	Yak
1	Goat	Monkey

Clues:

Hen was caged in the flat which is three floors above Cow but in a different flat as Cow. Bull was caged in one of the odd numbered floors and flat. Camel was not caged on the same floor as Bull.

Inference:

From above condition case 2a get cancelled.

Floors	Flat 1	Flat 2	Floors	Flat 1	Flat 2
	Case 2			Case 2a	
6	Buffalo	Hen	6		Buffalo
5	Bull		5		
4	Camel	Ox	4		Ox
3	Cow	Sheep	3		Sheep
2	Duck	Yak	2	Duck	Yak
1	Goat	Monkey	1	Goat	Monkey

Inference:

We know Donkey is one of the animals, so the final arrangement is :-

Floors	Flat 1	Flat 2
6	Buffalo	Hen
5	Bull	Donkey
4	Camel	Ox
3	Cow	Sheep
2	Duck	Yak
1	Goat	Monkey

Camel was caged on the same floor as Ox.

S160. Ans.(a)

Sol. Final arrangement:

Floors	Flat 1	Flat 2
6	Buffalo	Hen
5	Bull	Donkey
4	Camel	Ox
3	Cow	Sheep
2	Duck	Yak
1	Goat	Monkey

Clues:

Not more than two floors are there below Duck whereas Sheep was caged on the floor immediately above Duck but in a different flat as Duck. The number of floors above Sheep is the same as the number of floors below Ox, which was not caged in flat 1 but in the same flat as Sheep. Two floors are there between Ox and Goat where both were caged in different flats.

Inference:

From above conditions we get three possibilities.

Floors	Flat 1	Flat 2	Floors	Flat 1	Flat 2	Floors	Flat 1	Flat 2
	Case 1			Case 2			Case 3	
6	Goat		6			6		
5			5			5		Ox
4		Sheep	4		Ox	4		
3	Duck	Ox	3		Sheep	3		
2			2	Duck		2	Goat	Sheep
1			1	Goat		1	Duck	

Clues:

The number of floors between Goat and Duck is one less than the number of floors between Ox and Buffalo which was not caged on the adjacent floor of Goat. The number of floors below Buffalo is one more than the number of floors above Yak. Monkey was caged in the flat immediately below Yak.

Inference:

From above conditions we get one more possibility and case 1 and case 3 get cancelled.

Floors	Flat 1	Flat 2	Floors	Flat 1	Flat 2	Floors	Flat 1	Flat 2
	Case-1			Case 2			Case-3	
6	Goat		6	Buffalo		6		
5			5			5		Ox
4		Sheep	4		Ox	4		
3	Duck	Ox	3		Sheep	3		Buffalo
2			2	Duck	Yak	2	Goat	Sheep
1			1	Goat	Monkey	1	Duck	

Floors	Flat 1	Flat 2
	Case 2a	
6		Buffalo
5		
4		Ox
3		Sheep
2	Duck	Yak
1	Goat	Monkey

Clues:

Hen was caged in the flat which is three floors above Cow but in a different flat as Cow. Bull was caged in one of the odd numbered floors and flat. Camel was not caged on the same floor as Bull.

Inference:

From above condition case 2a get cancelled.

Floors	Flat 1	Flat 2	Floors	Flat 1	Flat 2
	Case 2			Case 2a	
6	Buffalo	Hen	6		Buffalo
5	Bull		5		
4	Camel	Ox	4		Ox
3	Cow	Sheep	3		Sheep
2	Duck	Yak	2	Duck	Yak
1	Goat	Monkey	1	Goat	Monkey

Inference:

We know Donkey is one of the animals, so the final arrangement is :-

Floors	Flat 1	Flat 2
6	Buffalo	Hen
5	Bull	Donkey
4	Camel	Ox
3	Cow	Sheep
2	Duck	Yak
1	Goat	Monkey

Donkey was caged Flat 2 of floor 5.

S161. Ans.(a)

Sol. Final arrangement:

Floors	Flat 1	Flat 2
6	Buffalo	Hen
5	Bull	Donkey
4	Camel	Ox
3	Cow	Sheep
2	Duck	Yak
1	Goat	Monkey

Clues:

Not more than two floors are there below Duck whereas Sheep was caged on the floor immediately above Duck but in a different flat as Duck. The number of floors above Sheep is the same as the number of floors below Ox, which was not caged in flat 1 but in the same flat as Sheep. Two floors are there between Ox and Goat where both were caged in different flats.

Inference:

From above conditions we get three possibilities.

Floors	Flat 1	Flat 2	Floors	Flat 1	Flat 2	Floors	Flat 1	Flat 2
	Case 1			Case 2			Case 3	
6	Goat		6			6		
5			5			5		Ox
4		Sheep	4		Ox	4		
3	Duck	Ox	3		Sheep	3		
2			2	Duck	Yak	2	Goat	Sheep
1			1	Goat	Monkey	1	Duck	

Clues:

The number of floors between Goat and Duck is one less than the number of floors between Ox and Buffalo which was not caged on the adjacent floor of Goat. The number of floors below Buffalo is one more than the number of floors above Yak. Monkey was caged in the flat immediately below Yak.

Inference:

From above conditions we get one more possibility and case 1 and case 3 get cancelled.

Floors	Flat 1	Flat 2	Floors	Flat 1	Flat 2	Floors	Flat 1	Flat 2
	Case 1			Case 2			Case 3	
6	Goat		6	Buffalo		6		
5			5			5		Ox
4		Sheep	4		Ox	4		
3	Duck	Ox	3		Sheep	3		Buffalo
2			2	Duck	Yak	2	Goat	Sheep
1			1	Goat	Monkey	1	Duck	

Floors	Flat 1	Flat 2
	Case 2a	
6		Buffalo
5		
4		Ox
3		Sheep
2	Duck	Yak
1	Goat	Monkey

Clues:

Hen was caged in the flat which is three floors above Cow but in a different flat as Cow. Bull was caged in one of the odd numbered floors and flat. Camel was not caged on the same floor as Bull.

Inference:

From above condition case 2a get cancelled.

Floors	Flat 1	Flat 2	Floors	Flat 1	Flat 2
	Case 2			Case 2a	
6	Buffalo	Hen	6		Buffalo
5	Bull		5		
4	Camel	Ox	4		Ox
3	Cow	Sheep	3		Sheep
2	Duck	Yak	2	Duck	Yak
1	Goat	Monkey	1	Goat	Monkey

Inference:

We know Donkey is one of the animals, so the final arrangement is :-

Floors	Flat 1	Flat 2
6	Buffalo	Hen
5	Bull	Donkey
4	Camel	Ox
3	Cow	Sheep
2	Duck	Yak
1	Goat	Monkey

Except Yak, all animal in Flat 1.

S162. Ans.(c)

Sol. For row 1: 13 25 6

$$13 \ 25 = \text{Condition 4} = 25 - 13 = 12$$

$$12 \ 6 = \text{Condition 2} = 12 / 6 = 2$$

For row 2: 32 8 15

$$32 \ 8 = \text{Condition 2} = 32 / 8 = 4$$

$$4 \ 15 = \text{Condition 1} = 15 + 4 = 19$$

Then the product of the resultant of both the rows = $19 * 2 = 38$.

S163. Ans.(b)

Sol. For row1: 17 24 136

$$17 \ 24 = \text{Condition 3} = 17 * 24 = 408$$

$$408 \ 136 = \text{Condition 2} = 408 / 136 = 3$$

If X is 3 more than the resultant of the first row, then X is 6.

For row 2: 165 81 6

$$165 \ 81 = \text{Condition 4} = 165 - 81 = 84$$

$$84 \ 6 = \text{Condition 2} = 84 / 6 = 14$$

S164. Ans.(e)**Sol.** For row 1: 13 26 21

$13\ 26 = \text{Condition 3} = 13 \times 26 = 338$

$338\ 21 = \text{Condition 1} = 338 + 21 = 359$

For row 2: 192 24 69

$192\ 24 = \text{Condition 2} = 192 / 24 = 8$

$8\ 69 = \text{Condition 1} = 8 + 69 = 77$

The sum of the resultants of both the rows =

$359 + 77 = 436$

approximately 21 is the square root of 436.

S165. Ans.(e)**Sol.** For row 2: 34 45 9

$34\ 45 = \text{Condition 1} = 34 + 45 = 79$

$79\ 9 = \text{Condition 4} = 79 - 9 = 70$

Sum of the resultant of both the rows = 450

$\text{Resultant of first row} = 450 - 70 = 380$

For row 1: 84 11 X

$84\ 11 = \text{Condition 1} = 84 + 11 = 95$

95 X = If X is an odd number (but a perfect square), then the difference of both 95 and X is obtained but subtracting any odd perfect square number we cannot get the value as 380. So Conditions, 1, 2 and 4 are eliminated. Only if we apply Condition 3 we get the final answer.

$\text{Condition 3} = 95 \times X = 380$

$X = 380 / 95 = 4$

S166. Ans.(a)**Sol.** For row 1: 5 16 4

$5\ 16 = \text{Condition 4} = 16 - 5 = 11$

$11\ 4 = \text{Condition 3} = 11 \times 4 = 44$

For row 2: 32 8 7

$32\ 8 = \text{Condition 2} = 4$

$4\ 7 = \text{Condition 1} = 11$

$\text{So, the division} = 44 / 11 = 4$

S167. Ans.(c)**Sol. Final arrangement:**

Years	Persons	Movies
1993	R	Krrish 3
1996	U	Kesari
1998	T	Pathaan
2001	----	-----
2004	Q	Sanju
2009	S	Dangal
2012	----	-----
2015	P	RRR
2018	V	Bharat

Clues:

P was promoted in 2015 but neither likes Bharat nor Dangal. Three persons were promoted between P and the one who likes Kesari. Q was promoted in a leap year but not in 1996 and three persons before the one who likes Bharat. Q likes neither Kesari nor Pathaan.

Inference:

From the above conditions we get two possibilities.

Years	Persons	Movies	Years	Persons	Movies	Years	Persons	Movies
	Case 1			Case 2			Case 3	
1993			1993			1993		
1996			1996		Kesari	1996		
1998		Kesari	1998			1998		
2001			2001			2001		Kesari
2004	Q		2004	Q		2004	Q	
2009			2009			2009		
2012			2012			2012		
2015	P		2015	P		2015	P	
2018		Bharat	2018		Bharat	2018		Bharat

Clues:

One person was promoted between S and the one who likes Pathaan. The number of persons promoted between the one who likes Bharat and S is the same as the number of persons promoted before U. The one who likes Pathaan was promoted in an even numbered year. S was not promoted before the one who likes Pathaan.

Inference:

From above conditions we get one more possibility and case 1 and case 3 get cancelled.

Years	Persons	Movies	Years	Persons	Movies	Years	Persons	Movies
	Case 1			Case 2			Case 2a	
1993			1993			1993		
1996	—	—	1996	U	Kesari	1996	U	Kesari
1998		Kesari	1998		Pathaan	1998		Pathaan
2001	S		2001	-----	-----	2001	-----	-----
2004	Q		2004	Q		2004	Q	
2009	—	—	2009	S		2009	-----	-----
2012		Pathaan	2012	-----	-----	2012	S	
2015	P		2015	P		2015	P	
2018		Bharat	2018		Bharat	2018		Bharat

Years	Persons	Movies
	Case 3	
1993	-	-
1996		Pathaan
1998	-	-
2001		Kesari
2004	Q	
2009		
2012		
2015	P	
2018		Bharat

Clues:

R likes Krrish 3 and P doesn't like Sanju. The number of persons promoted between R and the one who likes Sanju is one more than the number of persons promoted after the one who likes RRR. The one who likes Dangal was not promoted in 2012. T doesn't like Bharat.

Inference:

From the above conditions case 2a is cancelled here.

Years	Persons	Movies	Years	Persons	Movies
Case 2			Case 2a		
1993	R	Krrish 3	1993	R	Krrish 3
1996	U	Kesari	1996	U	Kesari
1998	T	Pathaan	1998		Pathaan
2001	-----	-----	2001	---	---
2004	Q	Sanju	2004	Q	Sanju
2009	S	Dangal	2009	---	---
2012	-----	----	2012	S	Dangal
2015	P	RRR	2015	P	RRR
2018	V	Bharat	2018		Bharat

Inference:

After combining all the information we get final arrangement.

Years	Persons	Movies
1993	R	Krrish 3
1996	U	Kesari
1998	T	Pathaan
2001	----	-----
2004	Q	Sanju
2009	S	Dangal
2012	----	-----
2015	P	RRR
2018	V	Bharat

Q likes Sanju.

S168. Ans.(c)**Sol. Final arrangement:**

Years	Persons	Movies
1993	R	Krrish 3
1996	U	Kesari
1998	T	Pathaan
2001	----	-----
2004	Q	Sanju
2009	S	Dangal
2012	----	-----
2015	P	RRR
2018	V	Bharat

Clues:

P was promoted in 2015 but neither likes Bharat nor Dangal. Three persons were promoted between P and the one who likes Kesari. Q was promoted in a leap year but not in 1996, and three persons before the one who likes Bharat. Q likes neither Kesari nor Pathaan.

Inference:

From the above conditions we get two possibilities.

Years	Persons	Movies	Years	Persons	Movies	Years	Persons	Movies
Case 1			Case 2			Case 3		
1993			1993			1993		
1996			1996		Kesari	1996		
1998		Kesari	1998			1998		
2001			2001			2001		Kesari
2004	Q		2004	Q		2004	Q	
2009			2009			2009		
2012			2012			2012		
2015	P		2015	P		2015	P	
2018		Bharat	2018		Bharat	2018		Bharat

Clues:

One person was promoted between S and the one who likes Pathaan. The number of persons promoted between the one who likes Bharat and S is the same as the number of persons promoted before U. The one who likes Pathaan was promoted in an even numbered year. S was not promoted before the one who likes Pathaan.

Inference:

From above conditions we get one more possibility and case 1 and case 3 get cancelled.

Years	Persons	Movies	Years	Persons	Movies	Years	Persons	Movies
Case 1			Case 2			Case 2a		
1993			1993			1993		
1996	—	—	1996	U	Kesari	1996	U	Kesari
1998		Kesari	1998		Pathaan	1998		Pathaan
2001	S		2001	-----	-----	2001	-----	-----
2004	Q		2004	Q		2004	Q	
2009	—	—	2009	S		2009	-----	-----
2012		Pathaan	2012	-----	-----	2012	S	
2015	P		2015	P		2015	P	
2018		Bharat	2018		Bharat	2018		Bharat

Years	Persons	Movies
Case-3		
1993	-	-
1996		Pathaan
1998	-	-
2001		Kesari
2004	Q	
2009		
2012		
2015	P	
2018		Bharat

Clues:

R likes Krrish 3 and P doesn't like Sanju. The number of persons promoted between R and the one who likes Sanju is one more than the number of persons promoted after the one who likes RRR. The one who likes Dangal was not promoted in 2012. T doesn't like Bharat.

Inference:

From the above conditions case 2a is cancelled here.

Years	Persons	Movies	Years	Persons	Movies
	Case 2			Case-2a	
1993	R	Krrish 3	1993	R	Krrish 3
1996	U	Kesari	1996	U	Kesari
1998	T	Pathaan	1998		Pathaan
2001	-----	-----	2001	---	---
2004	Q	Sanju	2004	Q	Sanju
2009	S	Dangal	2009	---	---
2012	----	----	2012	S	Dangal
2015	P	RRR	2015	P	RRR
2018	V	Bharat	2018		Bharat

Inference:

After combining all the information we get final arrangement.

Years	Persons	Movies
1993	R	Krrish 3
1996	U	Kesari
1998	T	Pathaan
2001	----	-----
2004	Q	Sanju
2009	S	Dangal
2012	----	-----
2015	P	RRR
2018	V	Bharat

The one who likes Kesari was promoted in 1996.

S169. Ans.(a)**Sol. Final arrangement:**

Years	Persons	Movies
1993	R	Krrish 3
1996	U	Kesari
1998	T	Pathaan
2001	----	-----
2004	Q	Sanju
2009	S	Dangal
2012	----	-----
2015	P	RRR
2018	V	Bharat

Clues:

P was promoted in 2015 but neither likes Bharat nor Dangal. Three persons were promoted between P and the one who likes Kesari. Q was promoted in a leap year but not in 1996 and three persons before the one who likes Bharat. Q likes neither Kesari nor Pathaan.

Inference:

From the above conditions we get two possibilities.

Years	Persons	Movies	Years	Persons	Movies	Years	Persons	Movies
	Case 1			Case 2			Case 3	
1993			1993			1993		
1996			1996		Kesari	1996		
1998		Kesari	1998			1998		
2001			2001			2001		Kesari
2004	Q		2004	Q		2004	Q	
2009			2009			2009		
2012			2012			2012		
2015	P		2015	P		2015	P	
2018		Bharat	2018		Bharat	2018		Bharat

Clues:

One person was promoted between S and the one who likes Pathaan. The number of persons promoted between the one who likes Bharat and S is the same as the number of persons promoted before U. The one who likes Pathaan was promoted in an even numbered year. S was not promoted before the one who likes Pathaan.

Inference:

From above conditions we get one more possibility and case 1 and case 3 get cancelled.

Years	Persons	Movies	Years	Persons	Movies	Years	Persons	Movies
	Case 1			Case 2			Case 2a	
1993			1993			1993		
1996	—	—	1996	U	Kesari	1996	U	Kesari
1998		Kesari	1998		Pathaan	1998		Pathaan
2001	S		2001	----	----	2001	----	----
2004	Q		2004	Q		2004	Q	
2009	—	—	2009	S		2009	----	----
2012		Pathaan	2012	----	----	2012	S	
2015	P		2015	P		2015	P	
2018		Bharat	2018		Bharat	2018		Bharat

Years	Persons	Movies
	Case 3	
1993	-	-
1996		Pathaan
1998	-	-
2001		Kesari
2004	Q	
2009		
2012		
2015	P	
2018		Bharat

Clues:

R likes Krrish 3 and P doesn't like Sanju. The number of persons promoted between R and the one who likes Sanju is one more than the number of persons promoted after the one who likes RRR. The one who likes Dangal was not promoted in 2012. T doesn't like Bharat.

Inference:

From the above conditions case 2a is cancelled here.

Years	Persons	Movies	Years	Persons	Movies
	Case 2			Case-2a	
1993	R	Krrish 3	1993	R	Krrish 3
1996	U	Kesari	1996	U	Kesari
1998	T	Pathaan	1998		Pathaan
2001	-----	-----	2001	---	---
2004	Q	Sanju	2004	Q	Sanju
2009	S	Dangal	2009	---	---
2012	-----	-----	2012	S	Dangal
2015	P	RRR	2015	P	RRR
2018	V	Bharat	2018		Bharat

Inference:

After combining all the information we get final arrangement.

Years	Persons	Movies
1993	R	Krrish 3
1996	U	Kesari
1998	T	Pathaan
2001	----	-----
2004	Q	Sanju
2009	S	Dangal
2012	----	-----
2015	P	RRR
2018	V	Bharat

T likes Pathaan.

S170. Ans.(e)**Sol. Final arrangement:**

Years	Persons	Movies
1993	R	Krrish 3
1996	U	Kesari
1998	T	Pathaan
2001	----	-----
2004	Q	Sanju
2009	S	Dangal
2012	----	-----
2015	P	RRR
2018	V	Bharat

Clues:

P was promoted in 2015 but neither likes Bharat nor Dangal. Three persons were promoted between P and the one who likes Kesari. Q was promoted in a leap year but not in 1996, and three persons before the one who likes Bharat. Q likes neither Kesari nor Pathaan.

Inference:

From the above conditions we get two possibilities.

Years	Persons	Movies	Years	Persons	Movies	Years	Persons	Movies
	Case 1			Case 2			Case 3	
1993			1993			1993		
1996			1996		Kesari	1996		
1998		Kesari	1998			1998		
2001			2001			2001		Kesari
2004	Q		2004	Q		2004	Q	
2009			2009			2009		
2012			2012			2012		
2015	P		2015	P		2015	P	
2018		Bharat	2018		Bharat	2018		Bharat

Clues:

One person was promoted between S and the one who likes Pathaan. The number of persons promoted between the one who likes Bharat and S is the same as the number of persons promoted before U. The one who likes Pathaan was promoted in an even numbered year. S was not promoted before the one who likes Pathaan.

Inference:

From above conditions we get one more possibility and case 1 and case 3 get cancelled.

Years	Persons	Movies	Years	Persons	Movies	Years	Persons	Movies
	Case 1			Case 2			Case 2a	
1993			1993			1993		
1996	—	—	1996	U	Kesari	1996	U	Kesari
1998		Kesari	1998		Pathaan	1998		Pathaan
2001	S		2001	-----	-----	2001	-----	-----
2004	Q		2004	Q		2004	Q	
2009	—	—	2009	S		2009	-----	-----
2012		Pathaan	2012	-----	-----	2012	S	
2015	P		2015	P		2015	P	
2018		Bharat	2018		Bharat	2018		Bharat

Years	Persons	Movies
	Case 3	
1993	-	-
1996		Pathaan
1998	-	-
2001		Kesari
2004	Q	
2009		
2012		
2015	P	
2018		Bharat

Clues:

R likes Krrish 3 and P doesn't like Sanju. The number of persons promoted between R and the one who likes Sanju is one more than the number of persons promoted after the one who likes RRR. The one who likes Dangal was not promoted in 2012. T doesn't like Bharat.

Inference:

From the above conditions case 2a is cancelled here.

Years	Persons	Movies	Years	Persons	Movies
	Case 2			Case-2a	
1993	R	Krrish 3	1993	R	Krrish 3
1996	U	Kesari	1996	U	Kesari
1998	T	Pathaan	1998		Pathaan
2001	-----	-----	2001	---	---
2004	Q	Sanju	2004	Q	Sanju
2009	S	Dangal	2009	---	---
2012	----	----	2012	S	Dangal
2015	P	RRR	2015	P	RRR
2018	V	Bharat	2018		Bharat

Inference:

After combining all the information we get final arrangement.

Years	Persons	Movies
1993	R	Krrish 3
1996	U	Kesari
1998	T	Pathaan
2001	----	-----
2004	Q	Sanju
2009	S	Dangal
2012	----	-----
2015	P	RRR
2018	V	Bharat

No one was promoted between the one who likes Kesari and T.

S171. Ans.(b)

Sol. Final arrangement:

Years	Persons	Movies
1993	R	Krrish 3
1996	U	Kesari
1998	T	Pathaan
2001	----	-----
2004	Q	Sanju
2009	S	Dangal
2012	----	-----
2015	P	RRR
2018	V	Bharat

Clues:

P was promoted in 2015 but neither likes Bharat nor Dangal. Three persons were promoted between P and the one who likes Kesari. Q was promoted in a leap year but not in 1996, and three persons before the one who likes Bharat. Q likes neither Kesari nor Pathaan.

Inference:

From the above conditions we get two possibilities.

Years	Persons	Movies	Years	Persons	Movies	Years	Persons	Movies
Case 1			Case 2			Case 3		
1993			1993			1993		
1996			1996		Kesari	1996		
1998		Kesari	1998			1998		
2001			2001			2001		Kesari
2004	Q		2004	Q		2004	Q	
2009			2009			2009		
2012			2012			2012		
2015	P		2015	P		2015	P	
2018		Bharat	2018		Bharat	2018		Bharat

Clues:

One person was promoted between S and the one who likes Pathaan. The number of persons promoted between the one who likes Bharat and S is the same as the number of persons promoted before U. The one who likes Pathaan was promoted in an even numbered year. S was not promoted before the one who likes Pathaan.

Inference:

From above conditions we get one more possibility and case 1 and case 3 get cancelled.

Years	Persons	Movies	Years	Persons	Movies	Years	Persons	Movies
Case 1			Case 2			Case 2a		
1993			1993			1993		
1996	—	—	1996	U	Kesari	1996	U	Kesari
1998		Kesari	1998		Pathaan	1998		Pathaan
2001	S		2001	----	----	2001	----	----
2004	Q		2004	Q		2004	Q	
2009	—	—	2009	S		2009	----	----
2012		Pathaan	2012	----	----	2012	S	
2015	P		2015	P		2015	P	
2018		Bharat	2018		Bharat	2018		Bharat

Years	Persons	Movies
Case 3		
1993	-	-
1996		Pathaan
1998	-	-
2001		Kesari
2004	Q	
2009		
2012		
2015	P	
2018		Bharat

Clues:

R likes Krrish 3 and P doesn't like Sanju. The number of persons promoted between R and the one who likes Sanju is one more than the number of persons promoted after the one who likes RRR. The one who likes Dangal was not promoted in 2012. T doesn't like Bharat.

Inference:

From the above conditions case 2a is cancelled here.

Years	Persons	Movies	Years	Persons	Movies
Case 2			Case-2a		
1993	R	Krrish 3	1993	R	Krrish-3
1996	U	Kesari	1996	U	Kesari
1998	T	Pathaan	1998		Pathaan
2001	-----	-----	2001	---	---
2004	Q	Sanju	2004	Q	Sanju
2009	S	Dangal	2009	---	---
2012	-----	-----	2012	S	Dangal
2015	P	RRR	2015	P	RRR
2018	V	Bharat	2018		Bharat

Inference:

After combining all the information we get final arrangement.

Years	Persons	Movies
1993	R	Krrish 3
1996	U	Kesari
1998	T	Pathaan
2001	---	-----
2004	Q	Sanju
2009	S	Dangal
2012	---	-----
2015	P	RRR
2018	V	Bharat

Only statement (b) is true.

S172. Ans.(a)

Sol.

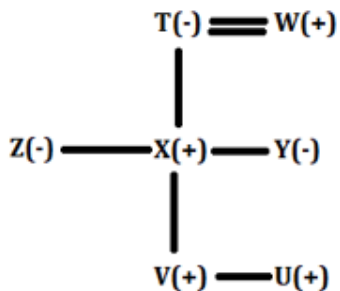

U # Y # X means the gender of U and Y is different. Gender of Y and X is different.

S173. Ans.(b)

Sol.

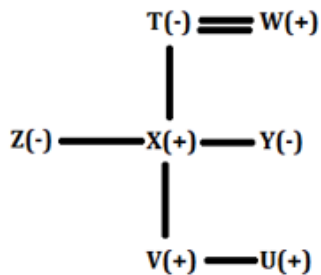

Z is daughter of U's aunt's mother i.e., T.

S174. Ans.(c)

Sol.

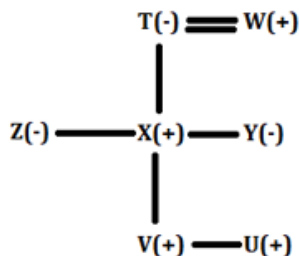

Z's brother is X.

W is the father of X.

S175. Ans.(c)

Sol. Final arrangement:

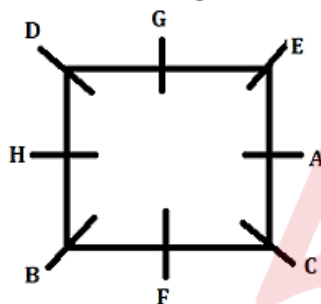

Clues:

F is an immediate neighbour of C who sits at the corner of the table. B sits third to the left of A. One person sits between B and C. As many persons sit between B and F as between B and H.

Inference:

From above conditions there are three possibilities.

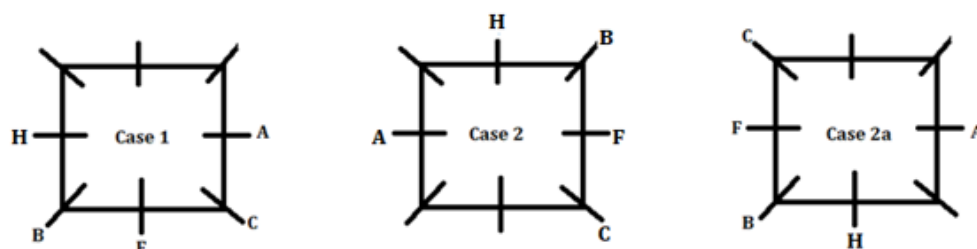

Clues:

E sits second to the left of D. The number of persons sitting between G and A is one less than the number of persons sitting between D and A when counted from the left of both D and G.

Inference:

From above conditions case 2 and case 2a get cancelled here.

A

BANK MAHAPACK PLUS

For IBPS, SBI, SIDBI, RBI
Grade B, +5 More

Selection Ka Saathi

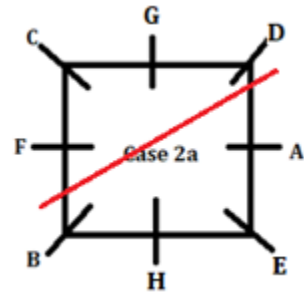
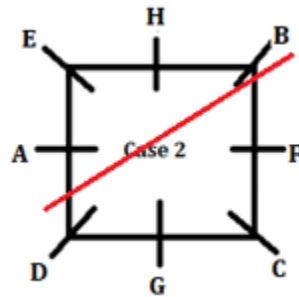
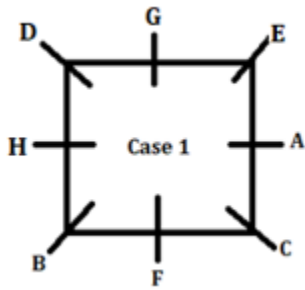

Inference:

After combining all the information, we get final arrangement.

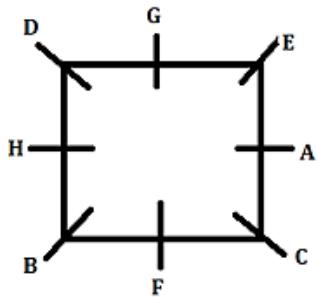

B sit second to the left of C.

S176. Ans.(d)

Sol. Final arrangement:

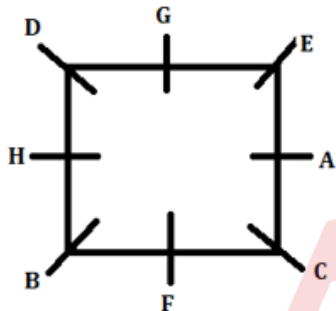

Clues:

F is an immediate neighbour of C who sits at the corner of the table. B sits third to the left of A. One person sits between B and C. As many persons sit between B and F as between B and H.

Inference:

From above conditions there are three possibilities.

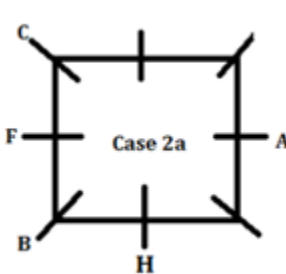
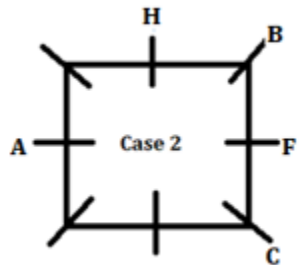
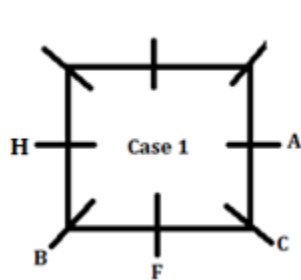

Clues:

E sits second to the left of D. The number of persons sitting between G and A is one less than the number of persons sitting between D and A when counted from the left of both D and G.

Inference:

From above conditions case 2 and case 2a get cancelled here.

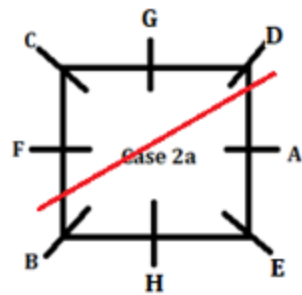
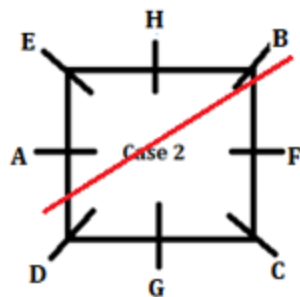
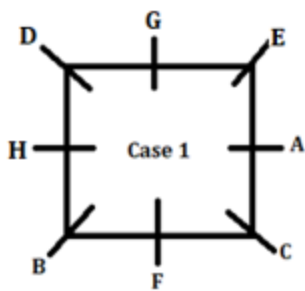

Inference:

After combining all the information, we get final arrangement.

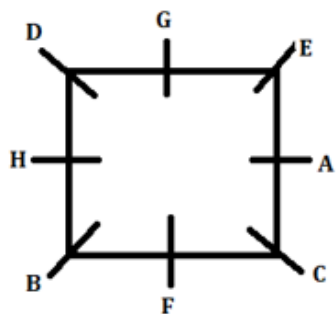

HD are immediate neighbours of each other.

S177. Ans.(e)

Sol. Final arrangement:

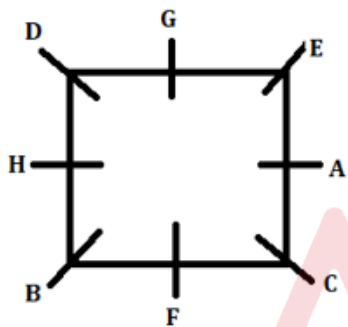

Clues:

F is an immediate neighbour of C who sits at the corner of the table. B sits third to the left of A. One person sits between B and C. As many persons sit between B and F as between B and H.

Inference:

From above conditions there are three possibilities.

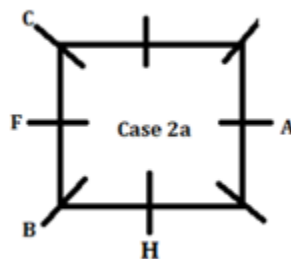
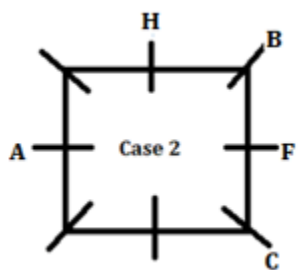
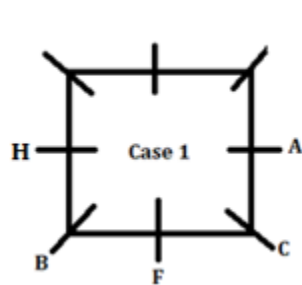

Clues:

E sits second to the left of D. The number of persons sitting between G and A is one less than the number of persons sitting between D and A when counted from the left of both D and G.

Inference:

From above conditions case 2 and case 2a get cancelled here.

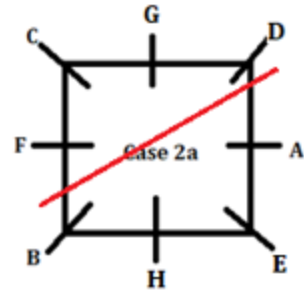
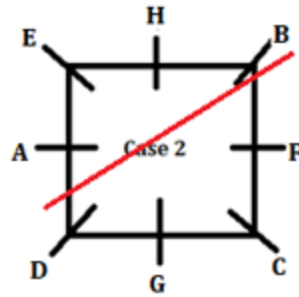
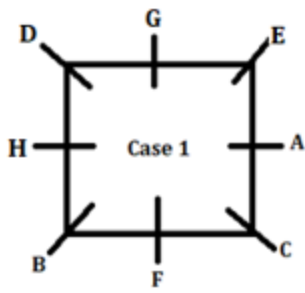

Inference:

After combining all the information, we get final arrangement.

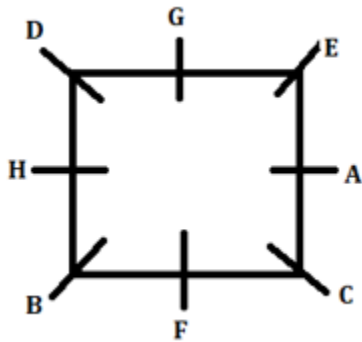

Only one person is unchanged in its position.

S178. Ans.(a)

Sol. Final arrangement:

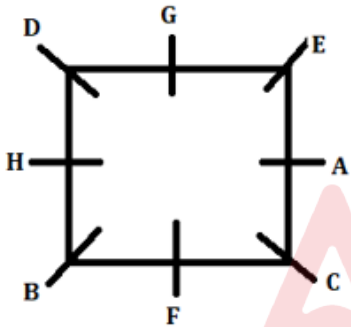

Clues:

F is an immediate neighbour of C who sits at the corner of the table. B sits third to the left of A. One person sits between B and C. As many persons sit between B and F as between B and H.

Inference:

From above conditions there are three possibilities.

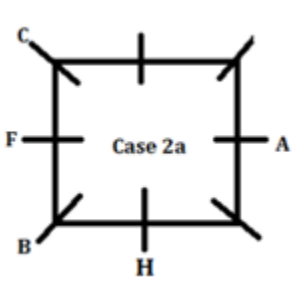
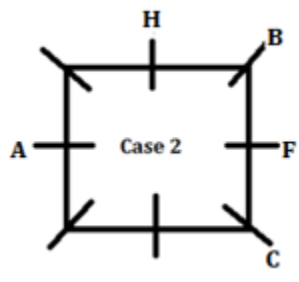
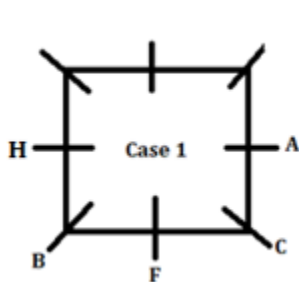

Clues:

E sits second to the left of D. The number of persons sitting between G and A is one less than the number of persons sitting between D and A when counted from the left of both D and G.

Inference:

From above conditions case 2 and case 2a get cancelled here.

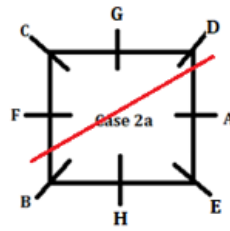
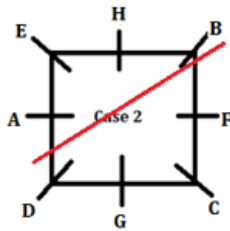
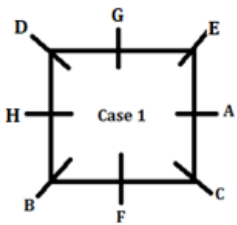

Inference:

After combining all the information, we get final arrangement.

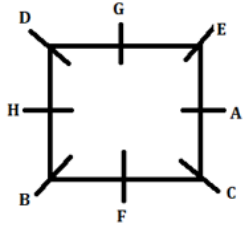

Position of C is third to the right of H.

S179. Ans.(b)

Sol. Final arrangement:

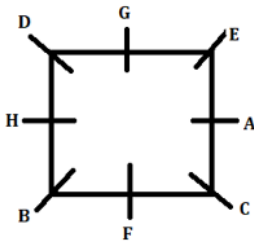

Clues:

F is an immediate neighbour of C who sits at the corner of the table. B sits third to the left of A. One person sits between B and C. As many persons sit between B and F as between B and H.

Inference:

From above conditions there are three possibilities.

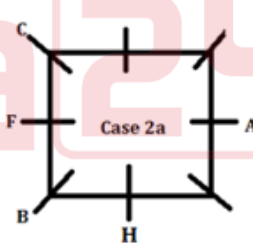
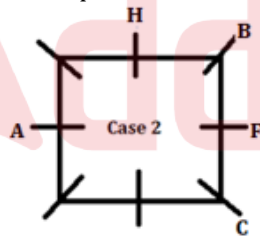
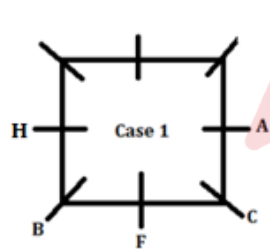

Clues:

E sits second to the left of D. The number of persons sitting between G and A is one less than the number of persons sitting between D and A when counted from the left of both D and G.

Inference:

From above conditions case 2 and case 2a get cancelled here.

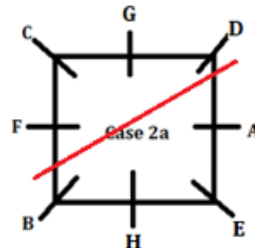
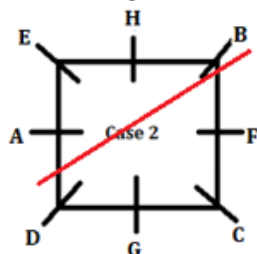
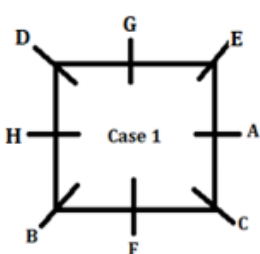

Inference:

After combining all the information, we get final arrangement.

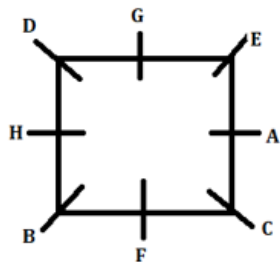

Only II and III are false.

S180. Ans.(d)

Sol. Given arrangement: **N ! 5 T 2 O @ Q 1 W R \$ 6 O ^ P U * J 7 S % D 8 F ? 9 A V + B > 3 Z P K**

After arrangement: **N ! T O @ Q W R \$ O ^ P U * J S % D F ? A V + B > Z P K 9 8 7 6 5 3 2 1**

S181. Ans.(b)

Sol. Given arrangement: **N ! 5 T 2 O @ Q 1 W R \$ 6 O ^ P U * J 7 S % D 8 F ? 9 A V + B > 3 Z P K**

After symbol and number are dropped: **N T O Q W R O P U J S D F A V B Z P K**

S182. Ans.(a)

Sol. Given series: **N ! 5 T 2 O @ Q 1 W R \$ 6 O ^ P U * J 7 S % D 8 F ? 9 A V + B > 3 Z P K**

Except (a), Three elements are between the first and the second element.

S183. Ans.(a)

Sol. **N ! 5 T 2 O @ Q 1 W R \$ 6 O ^ P U * J 7 S % D 8 F ? 9 A V + B > 3 Z P K**

S184. Ans.(e)

Sol. **N ! 5 T 2 O @ Q 1 W R \$ 6 O ^ P U * J 7 S % D 8 F ? 9 A V + B > 3 Z P K**

Required sum - $2+6+9 = 17$.

S185. Ans.(c)

Sol. **68395722689 - 57486833578**

Sum of all the digits which are repeated more than once $8+5+7+3 = 23$

S186. Ans.(d)

Sol.

Input:



Step I:



Step II:



Step III:



Step IV:



Step 1: Find the difference between the first and the fifth numbers then reverse the digits, second and sixth number and so on. If the difference is one-digit number then make it two-digit number for example: $81-74=07$ (its reverse is taken as 70).

Step 2: Add the first two numbers and reduce it to half of its value and continue for the rest of the numbers.

Step 3: The first digit of the first number and the second digit of the second number is added and the second digit of the first number and the first digit of the second number is added and the product of both the results are obtained and so on.

Step 4: The product of the digits of the first number is added to the product of the digits of the last number.

00 is the final step box number of given input.

S187. Ans.(a)

Sol.

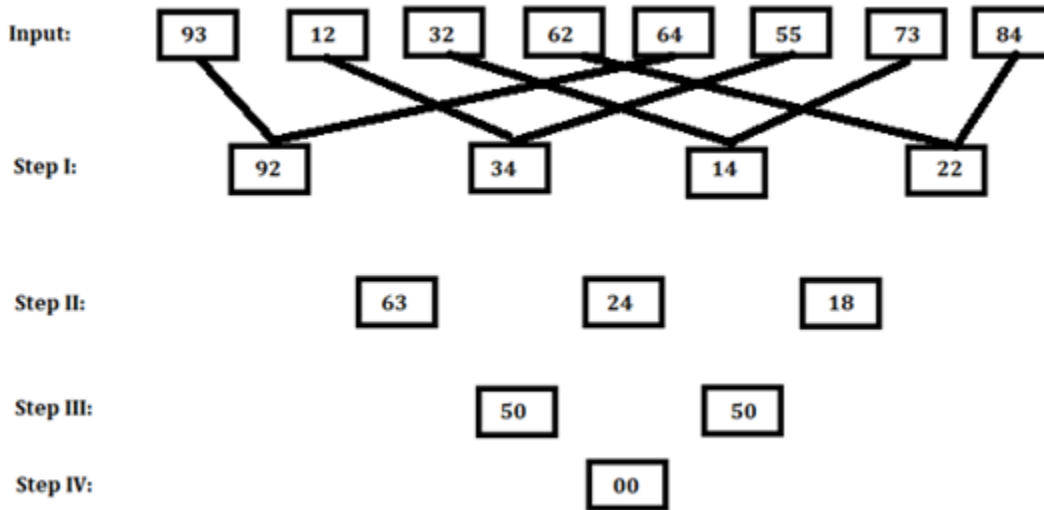

Step 1: Find the difference between the first and the fifth numbers then reverse the digits, second and sixth number and so on. If the difference is one-digit number then make it two-digit number for example: $81-74=07$ (its reverse is taken as 70).

Step 2: Add the first two numbers and reduce it to half of its value and continue for the rest of the numbers.

Step 3: The first digit of the first number and the second digit of the second number is added and the second digit of the first number and the first digit of the second number is added and the product of both the results are obtained and so on.

Step 4: The product of the digits of the first number is added to the product of the digits of the last number.

The difference between the second and the last numbers from the left end in step 1 of the given input is $= 34-22 = 12$.

S188. Ans.(c)

Sol.

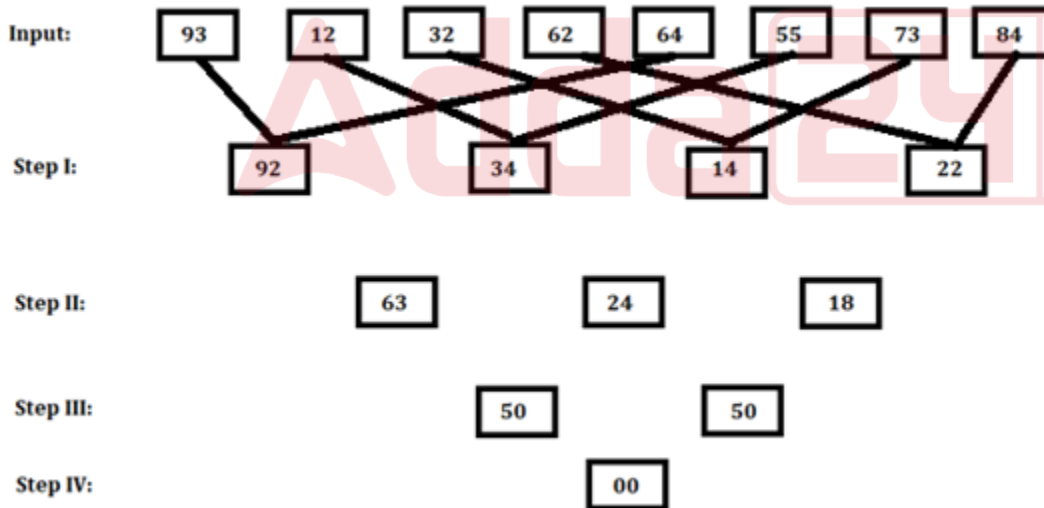

Step 1: Find the difference between the first and the fifth numbers then reverse the digits, second and sixth number and so on. If the difference is one-digit number then make it two-digit number for example: $81-74=07$ (its reverse is taken as 70).

Step 2: Add the first two numbers and reduce it to half of its value and continue for the rest of the numbers.

Step 3: The first digit of the first number and the second digit of the second number is added and the second digit of the first number and the first digit of the second number is added and the product of both the results are obtained and so on.

Step 4: The product of the digits of the first number is added to the product of the digits of the last number.

The third number from the right end in step II is 63.

S189. Ans.(d)

Sol.

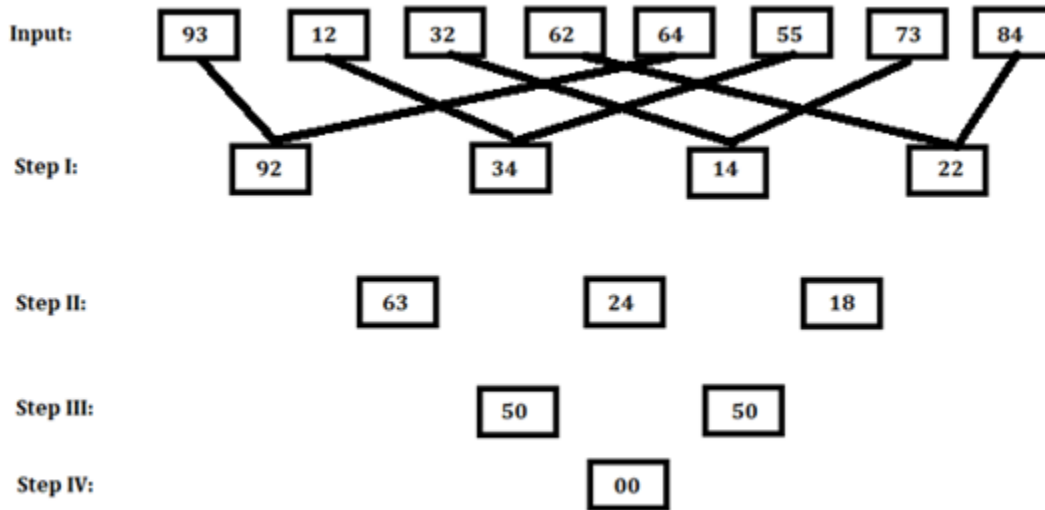

Step 1: Find the difference between the first and the fifth numbers then reverse the digits, second and sixth number and so on. If the difference is one-digit number then make it two-digit number for example: $81-74=07$ (its reverse is taken as 70).

Step 2: Add the first two numbers and reduce it to half of its value and continue for the rest of the numbers.

Step 3: The first digit of the first number and the second digit of the second number is added and the second digit of the first number and the first digit of the second number is added and the product of both the results are obtained and so on.

Step 4: The product of the digits of the first number is added to the product of the digits of the last number.

The square of the third number from the left end in step I is 196.

S190. Ans.(b)

Sol.

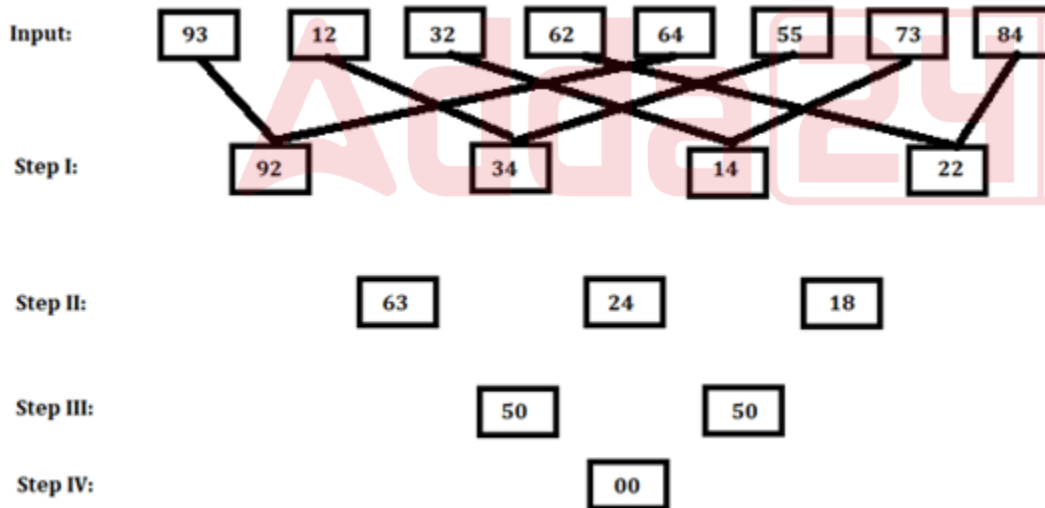

Step 1: Find the difference between the first and the fifth numbers then reverse the digits, second and sixth number and so on. If the difference is one-digit number then make it two-digit number for example: $81-74=07$ (its reverse is taken as 70).

Step 2: Add the first two numbers and reduce it to half of its value and continue for the rest of the numbers.

Step 3: The first digit of the first number and the second digit of the second number is added and the second digit of the first number and the first digit of the second number is added and the product of both the results are obtained and so on.

Step 4: The product of the digits of the first number is added to the product of the digits of the last number.

The sum of the second number from the left end in step I and in step III = $34+50=84$.

S191. Ans.(a)

Sol. From statement I, II, and III alone, we cannot determine the person sitting to the immediate left of S.

By combining I and III,

S sits second to the right of P. There is one person between Q and P. T does not face in north. R and S face in same direction. R sits exactly between U and T who does not sit at any end. U is not adjacent to Q.

So, the arrangement is shown below

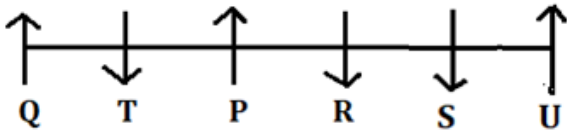

So, U sits to the immediate left of S.

S192. Ans.(d)

Sol. First we number the parking positions from 1 to 6 starting from the left end of the row.

On combining statement, I, II, and III we get Bus R which is parked two places away from bus Q and parked third to the left of bus U. Bus U which is parked at one end of the row and immediate neighbour of bus T so, bus Q, bus T, bus R and bus U are parked at 1, 5, 3 and 6 respectively. Bus S which is parked two places away from the bus which is parked at one end of the row so, bus S and bus V are parked at 2 and 4 respectively. The final arrangement is shown below:

Numbers	1	2	3	4	5	6
Buses	Q	V	R	S	T	U

Bus R and bus T are immediate neighbours of bus V. Therefore, all three statements are not redundant.

S193. Ans.(a)

Sol. From statement I alone: N sits third to the left of P One person sits between P and M who is not adjacent to N. O sits immediate left of Q. R does not sit adjacent o P

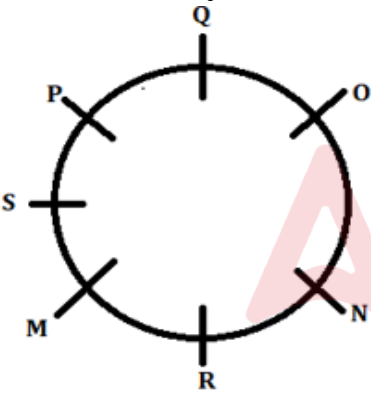

So, R sits immediate right of M.

From statement II: we cannot determine the person immediate right of M.

From statement III: R sits third to the right of P who sits immediate right of Q. M sits immediate right of S who doesn't sit adjacent to R. O does not sit adjacent to R.

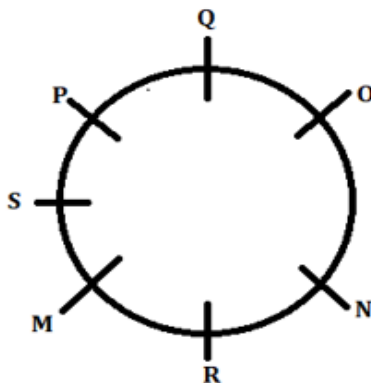

S194. Ans.(a)**Sol. I.** $N < X - (N \leq G < L < Z \leq X) = \text{True}$ **II.** $M > L - (L < Z \leq X > M) = \text{False}$ **S195. Ans.(e)****Sol. I.** $C \leq T - (C = Y \leq X \leq M \leq T) = \text{True}$ **II.** $A > Y - (Y \leq X \leq M \leq T < S = Z < A) = \text{True}$ **S196. Ans.(d)****Sol. I.** $M > J - (M \geq P = W < Q > J) = \text{False}$ **II.** $N < S - (N < M \geq P = W < Q > J \geq S) = \text{False}$ **S197. Ans.(c)****Sol. I.** $Q < R - (R \leq N = G \leq P = M \leq Q) = \text{False}$ **II.** $R = Q - (R \leq N = G \leq P = M \leq Q) = \text{False}$ **S198. Ans.(b)****Sol. I.** $T > Q - (T > L = J \leq R = Q) = \text{False}$ **II.** $N \geq L - (N \geq Q = R \geq J = L) = \text{True}$ **S199. Ans.(b)****Sol.** From statement II: we get 'water is very clean' is coded as 'bdc, ckc, Inc, lke' and 'you clean everyday' is coded as 'xte, snc, Inc'. So, 'clean' is coded as 'Inc' and 'water' is coded as 'ckc'.

From statement III: we get, 'liquid for take' is coded as 'ptc, kzc, roc' and 'take pure water' is coded as 'ckc, ptc, okc', so 'take' is coded as 'ptc' and 'water' must be coded as 'ckc' as 'okc' is the code of 'pure'.

S200. Ans.(c)**Sol.** From statement I: Box B is two boxes above Box A but not the topmost floor. Box E is 2nd box. We have:

Number	Boxes	Boxes
	Case 1	Case 2
6		
5	B	
4		
3	A	B
2	E	E
1		A

So, we cannot determine the topmost box.

From statement II: Box C is two boxes above Box E which is an even numbered box. Box F is just above Box B.

Number	Boxes	Boxes	Boxes
	Case 1	Case 2	Case 2a
6	F	C	C
5	B		
4	C	E	E
3		F	
2	E	B	F
1			B

So, we cannot decide the topmost box.

From statement III: Box E is the topmost box. Box C is just above Box A. So, we cannot decide the topmost box.

By combining I and II, we get:

Number	Boxes
6	F
5	B
4	C
3	A
2	E
1	D

So, Box F is the topmost box.

By Combining II and III, we get:

Number	Boxes	Boxes	Boxes
	Case 1	Case 2	Case 2a
6	F	C	C
5	B	A	A
4	C	E	E
3	A	F/B	D
2	E	B/F	F/B
1	D	D	B/F

So, we cannot determine the topmost box.

By Combining I and III, we get:

Number	Boxes
6	F/D
5	B
4	C
3	A
2	E
1	D/F

**RBI P2I
BATCH 4.0**
Live Foundation Batch
Target 2024

Starts: 11 Mar | 6 am - 10 pm

